



Precision threading technology

2022

www.threading-tools.com



Precision and Quality

Good quality is the best marketing, because satisfied customers underline our success.

Our most important principle which inspires us is the commitment for products of the highest standards to meet the requirements of our customers to their utmost satisfaction - a mission we try to fulfill for our corporate philosophy every day.

Our quality check starts with the receipt of goods and continues until the outgoing of the products. At BAER Company customer satisfaction does not come by chance. Ongoing quality testings also influence all new product developments. New ideas and the most modern production facilities improve our products and make them even more precise.



Development and Improvement

Essential for the sustainability of our work is to invest continuously the long-term in new innovative products. Highest efforts in research and development focus on the needs of our customers. Our tools represent practical and reliable solutions which support an efficient and easy application.

Our cooperations with other industries, companies and research institutes make a strong networking possible. New inspirations are created in innovations, are produced, tested and adapted for practice.

This way we are always up to the latest standards of knowledge related to thread technologies. All members of our company contribute to our innovations with their individual know-how.



Tradition and Experience

For more than 35 years we have been engaged in what we can do best: threading technology. With this far-reaching treasure trove of experience we have established ourselves as an expert by whom our customers can profit. We are proud to be a family company.

Our identification with the company is even stronger and more distinctive. Each customer, each modernization is at the same time an affair of the heart.

Tradition combined with innovation and progress - make us a flexible and competent partner when it is about threading tools.

Our claim: to contribute to a successful future and to develop tools which meet all kinds of requirements of our customers.



Distributors

For ensure further deliveries to the customer as soon as possible at home and abroad, we are expanding our distributor network. BAER-distributors benefit from:

- The largest full range of products - for best price performance ratio
- Quality and reliability - for the highest demands
- Decades of experience in threading technology
- Reliable partnership - flexible and easy
- Sale supporting materials
- Exclusive products
- Exclusive sale territories
- Qualified product and sales trainings
- Attractive terms and conditions
- Innovative products

M Metric coarse thread ISO DIN 13



Thread Cutting Sets p. 10-19 Short Machine Taps p. 20 Hand Tap Sets p. 21-23 Machine Taps p. 24-33 Forming Taps p. 34-35 Bit Taps p. 36-37 Round Dies p. 38-40 Hexagon Die Nuts p. 41

MF Metric fine thread ISO DIN 13



Thread Cutting Sets p. 42-43 Short Machine Taps p. 44 Hand Tap Sets p. 45-52 Machine Taps p. 53-65 Forming Taps p. 66 Bit Taps p. 67 Round Dies p. 68-73 Hexagon Die Nuts p. 74-75

G(BSP) British standard whitworth pipe thread DIN ISO 228



Thread Cutting Sets p. 76-77 Short Machine Taps p. 78 Hand Tap Sets p. 79 Machine Taps p. 80-81 Forming Taps p. 82 Round Dies p. 83 Hexagon Die Nuts p. 84

UNC Unified coarse thread ANSI B1.1



Thread Cutting Sets p. 86-87 Short Machine Taps p. 88 Hand Tap Sets p. 88 Machine Taps p. 89-90 Forming Taps p. 91 Combined Bit Taps p. 92 Round Dies p. 93 Hexagon Die Nuts p. 94

UNF Unified fine thread ANSI B1.1



Thread Cutting Sets p. 96-97 Short Machine Taps p. 98 Hand Tap Sets p. 98 Machine Taps p. 99-100 Forming Taps p. 101 Combined Bit Taps p. 102 Round Dies p. 103 Hexagon Die Nuts p. 104

UNS Unified thread with special threads per inch (TPI)



Machine Taps p. 105 Round Dies p. 105

UNEF Unified extra fine thread ANSI B1.1



Hand Tap Sets p. 106 Machine Taps p. 106 Round Dies p. 107

8-UN Unified thread series with 8-threads per inch (TPI)



Hand Tap Sets p. 108 Machine Taps p. 108 Round Dies p. 109 Hexagon Die Nuts p. 109

12-UN

Unified thread series with 12-threads per inch (TPI)



Hand Tap Sets
p. 110

Machine Taps
p. 110

Round Dies
p. 111

BSW

British standard BS 84 whitworth coarse thread



Thread Cutting Sets
p. 112-113

Hand Tap Sets
p. 114

Machine Taps
p. 115

Round Dies
p. 116

Hexagon Die Nuts
p. 117

BSF

British standard BS 84 whitworth fine thread



Thread Cutting Sets
p. 118-119

Short Machine Taps
p. 120

Hand Tap Sets
p. 120

Round Dies
p. 121

Hexagon Die Nuts
p. 121

TR

Trapezoidal thread DIN 103



Hand Tap Sets
p. 122

Machine Nut Taps
p. 123-124

Round Dies
p. 125

NPT

National standard taper 1:16 pipe thread ANSI B 1.20.1

NPTF

National standard sealing pipe thread ANSI B 1.20.3



Short Machine Taps
p. 126

Round Dies
p. 127

Hexagon Die Nuts
p. 127

NPS

National standard straight pipe thread



Short Machine Taps
p. 128

Round Dies
p. 128

RC (BSPT)

Whitworth tapered pipe thread DIN 2999

RP(BSPP)

British standard whitworth pipe thread ISO 7-1



Short Machine Taps
p. 129

Hexagon Die Nuts
p. 129

BA

British Association thread BS 93

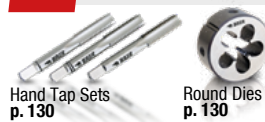

Hand Tap Sets
p. 130

Round Dies
p. 130

W

Tapered whitworth DIN 477 for screw sockets taper 3:25

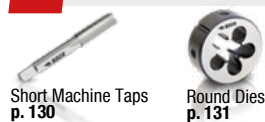

Short Machine Taps
p. 130

Round Dies
p. 131

PG Steel Conduit Thread DIN 40430



Short Machine Taps
p. 132



Round Dies
p. 132

FG Bicycle thread DIN 79012



Machine Taps
p. 133



Round Dies
p. 133

BSC British bicycle thread RS 811

RD Knuckle thread DIN 405



Machine Taps
p. 134



Round Dies
p. 134

RMS Royal Microscopical Society DIN 58888

MINI Metric Mini-thread and Nano-thread



Machine Taps
p. 135

CAMERA-Tripod Camera tripod and C-Mount thread DIN 4503



Short Machine Taps
p. 136



Hand Tap Sets
p. 136



Round Dies
p. 137

VG Valve thread DIN 7756



Short Machine Taps
p. 138

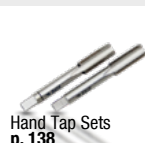

Hand Tap Sets
p. 138



Machine Taps
p. 138



Round Dies
p. 139

Holding Tools

Cutting Oil



Tap holders with ratchet
p. 140



Adjustable Tap Wrenches
p. 140

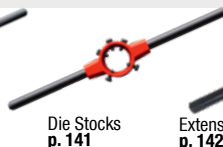

Die Stocks
p. 141



Extension sleeves for taps
p. 142

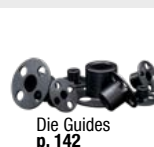

Die Guides
p. 142



Cutting Paste
p. 143



Countersinks
p. 143

Technical Information

p. 144 Tap Geometries

p. 144 Tap Centering

p. 145 Tap Construction dimensions

p. 145 Tap Chamfer Forms

p. 146 Tap flutes

p. 147 Tolerances

p. 148 Tap Surface Treatments

p. 148 Troubleshooting guide for tapping

p. 149 Tap Cutting speeds

p. 149 Lubrication and cooling

p. 150 Formula

p. 151 Round Dies Geometries

p. 151 Tolerances for Round Dies

p. 152 Cutting speeds for Machine Forming Taps

UNI-Tap - Unique cutting geometry

The unique geometry of UNI-Tap Taps is the result of years of research, which enables the user to machine all materials and makes the tap universally suitable for almost all applications.

During threading an internal thread, the major forces occur at the lead-in chamfer, which is strikingly relieved by structural changes in the UNI-Tap. The consequence is a reduced torque and a longer life time of the tap. In addition, the areas directly after the lead-in chamfer have been changed to lead the chip optimally and avoid possible jamming. An over-feeding of the thread is also not possible with this profile change.

The design sets new standards in ease of use, durability, and versatility

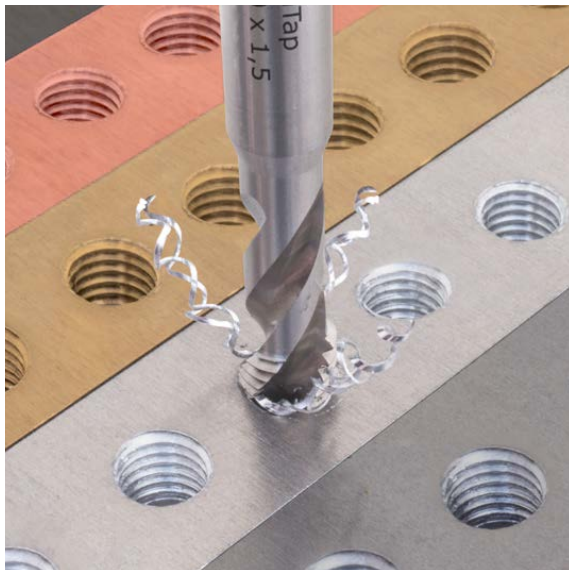
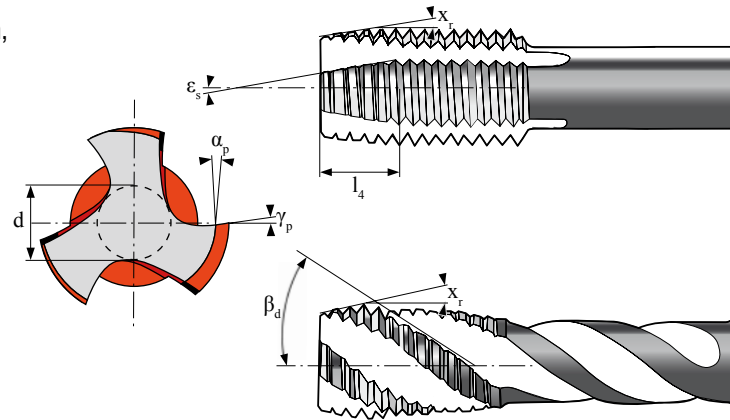

A professional for all applications and materials

- Steels and Steel alloys up to 1200 N/mm
- Stainless Steels; Inoxidable Steels up to 1000 N/mm; VASsteels; INOX; V2A; V4A
- Pure Aluminium; Aluminium Cast and Wrought Alloys
- Grey Cast Iron; Ductile/Nodular/Spheroidal Graphite Cast
- Iron; Malleable Cast Iron up to 1000 N/mm
- Pure Titanium and Titanium alloys up to 900 N/mm
- Pure Nickel and Nickel alloys up to 900 N/mm
- Pure Copper; Copper alloys; Brass; Bronze (all chip lengths)

Cost savings and flexibility

Due to its universal application possibilities, one UNI-Tap can do the work of several conventional taps.

As a result you can save about 90% of expenses.

Comparison of expenses:

Machine Taps M6 for	EUR / pc.
normal steels	6,98
stainless steels	11,68
aluminium and alloys	34,57
cast and grey cast iron	19,64
titanium and alloys	47,30
brass and copper	11,81
total:	131,98



same result with



BAER HSSE UNI-Tap Machine Tap for through holes M 6 x 1,0

17,33 EUR over 85% savings

Coatings

On request, taps are also available with a TIN or TiAlN coating. The TIN surface treatment (titanium-nitride gold-yellow) increases the surface hardness (approx. 2300 HV) and the sliding properties. As a result, it provides a better cutting performance and an increased tool life time. The TiAlN surface treatment increases the surface hardness (approx. 3300 HV), the sliding properties (friction coefficient: 0,25) and with the temperature resistance up to 800°C. As a result, it provides a better cutting performance and an increased tool life time.



Examples of application materials and cutting speeds

Soft Iron, Constructional Steel, Free Cutting Steel, Cementation Steel		cutting speed v_c in m/min for machine taps for through holes	cutting speed v_c in m/min for machine taps for blind holes	Carbon Steel, Spring Steel, Alloy Steel, Heat-treatable Steel		cutting speed v_c in m/min for machine taps for through holes	cutting speed v_c in m/min for machine taps for blind holes
1.1014	RFe80	25 - 50	25 - 50	1.0503	C45	20 - 30	20 - 30
1.0570	St52-3	25 - 50	25 - 50	1.1269	Ck85	20 - 30	20 - 30
1.0718	9SMnPb28	25 - 50	25 - 50	1.7218	25CrMo4	6 - 30	6 - 30
1.6523	20NiCrMo2	6 - 30	6 - 30	1.2344	X40CrMoV5-1	6 - 30	6 - 30
Stainless Steel, Inoxidable Steel (ferritic, austenitic, martensitic)		cutting speed v_c in m/min for machine taps for through holes	cutting speed v_c in m/min for machine taps for blind holes	Pure Nickel and Nickel alloys		cutting speed v_c in m/min for machine taps for through holes	cutting speed v_c in m/min for machine taps for blind holes
1.4104	X14CrMoS17	12 - 35	12 - 35	1.3926	RNi12	3 - 10	3 - 10
1.4301	X5CrNi18-10 (V2A)	12 - 15	12 - 15	2.4668	NiCr19Fe19NbMo (Inconel 718)	3 - 10	3 - 10
1.4571	X6CrNiMoTi17-12-2 (V4A)	12 - 15	12 - 15	2.4630	Ni-Cr20Ti (Nimonic 75)	1 - 5	1 - 5
1.4125	X105CrMo17	12 - 15	12 - 15	2.4665	NiCr22Fe18Mo (Hastelloy X)	1 - 5	1 - 5
Grey Cast Iron		cutting speed v_c in m/min for machine taps for through holes	cutting speed v_c in m/min for machine taps for blind holes	Ductile/Nodular/ Spheroidal Graphite Cast Iron, Malleable Cast Iron		cutting speed v_c in m/min for machine taps for through holes	cutting speed v_c in m/min for machine taps for blind holes
0.6010	GG10	35 - 50	35 - 50	0.7040	GGG40	12 - 45	12 - 45
0.6020	GG20	35 - 50	35 - 50	0.7060	GGG60	12 - 45	12 - 45
0.6030	GG30	35 - 50	35 - 50	0.7070	GGG70	12 - 45	12 - 45
0.6040	GG40	35 - 50	35 - 50	0.8035	GTW35-04	10 - 25	10 - 25
Pure Titanium and Titanium alloys		cutting speed v_c in m/min for machine taps for through holes	cutting speed v_c in m/min for machine taps for blind holes	Pure Copper and Copper alloys, Brass, Bronze (all chip lengths)		cutting speed v_c in m/min for machine taps for through holes	cutting speed v_c in m/min for machine taps for blind holes
3.7024	Ti99.5	3 - 15	3 - 15	2.0065	E-Cu 58	50 - 60	50 - 60
3.7034	Ti99.7	3 - 15	3 - 15	2.1247	CuBe2	30 - 65	30 - 65
3.7165	TiAl6V4	1 - 5	1 - 5	2.0360	CuZn40	30 - 65	30 - 65
3.7174	TiAl6V4Sn2	1 - 5	1 - 5	2.1020	CuSn6	12 - 20	12 - 20
Pure Aluminium, Aluminium Cast and Wrought Alloys (all chip lengths)		cutting speed v_c in m/min for machine taps for through holes	cutting speed v_c in m/min for machine taps for blind holes	cutting speed v_c [m/min] = (diameter * π * number of rotations) / 1000			
3.0205	Al99	50 - 65	50 - 65	number of rotations n [1/min] = (cutting speed in m/min * 1000) / (diameter * π)			
3.1645	AlCuMgPb	50 - 65	50 - 65	feed programming [mm/min] = number of rotations * pitch			
3.2373	G-AlSi9Mg	40 - 65	40 - 65	Please keep in mind that the cutting speeds as stated above serve only as guidelines. The right cutting speed depends on lubrication and application.			
3.2583	G-AlSi12(Cu)	40 - 65	40 - 65	Cutting paste, cutting oil or emulsion is recommended.			

Custom-made products

Special tools on request

Our customers benefit from our flexibility and our technical know-how when it comes to design and manufacture special threading tools.

- special thread profiles
- special Taps
- special sizes
- special Dies
- intermediate sizes
- special material
- special geometries
- express-productions

Examples of our custom-made products



Custom-made products



Send us your inquiry

BAER Vertriebs GmbH
Robert-Bosch-Str. 5
68542 Heddesheim
Germany

Tel: +49 (0) 6203 4048 790
Fax: +49 (0) 6203 4048 791
E-Mail: info@gewindebohrer.de
www.threading-tools.com

M

metric coarse thread / ISO DIN 13

193,20 €

 Item No.:
UNISD312

net prices without VAT or tax



BAER UNiTap Set M 3 - M 12

 HSSE UNiTap Machine Taps for through holes
incl. HSSE/Co extreme drill bits for core holes

 through
holes up to
4 x D

 chip removal
(like picture)

 Form B with
spiral point

4-5 threads

TOL

ISO2/6H

Set Content

BAER UNiTap HSSE Machine Taps for through holes	M 3 x 0,5 M 4 x 0,7 M 5 x 0,8 M 6 x 1,0 M 8 x 1,25 M 10 x 1,5 M 12 x 1,75
---	---

BAER HSSE/Co extreme drill bits for core holes	2,5 mm 3,3 mm 4,2 mm 5,0 mm 6,8 mm 8,5 mm 10,2 mm
---	--

BAER UNiTap Set M 3 - M 12

 HSSE UNiTap Machine Taps for blind holes
incl. HSSE/Co Extreme drill bits for core holes

195,30 €

 Item No.:
UNISS312

net prices without VAT or tax

 blind holes
up to 3 x D

 chip removal
(like picture)

 Form C 40°
right spiral
flutes

2-3 threads

TOL

ISO2/6H

Set Content

BAER UNiTap HSSE Machine Taps for through holes	M 3 x 0,5 M 4 x 0,7 M 5 x 0,8 M 6 x 1,0 M 8 x 1,25 M 10 x 1,5 M 12 x 1,75
---	---

BAER HSSE/Co extreme drill bits for core holes	2,5 mm 3,3 mm 4,2 mm 5,0 mm 6,8 mm 8,5 mm 10,2 mm
---	--



M

metric coarse thread / ISO DIN 13

BAER Short Machine Taps Set M 3 - M 12

HSSG Short Machine Taps

incl. HSS drill bits for core holes and tap wrench



through- & blind holes up to 2 x D



Chip removal (like picture)



Form C straight flutes



2-3 threads

TOL

ISO2/6H

Set Content

BAER HSSG Short Machine Taps	M 3 x 0,5 M 4 x 0,7 M 5 x 0,8 M 6 x 1,0 M 8 x 1,25 M 10 x 1,5 M 12 x 1,75
------------------------------	--

BAER HSSG Drill bits for core holes	2,5 mm 3,3 mm 4,2 mm 5,0 mm 6,8 mm 8,5 mm 10,2 mm
-------------------------------------	--

BAER adjustable Tap Wrenches - zinc die cast	M 1-12 1/16-1/2 G 1/8
--	---------------------------

61,60 €

Item No.: B1928

net prices without VAT or tax

105,00 €

Item No.: B1929

net prices without VAT or tax



BAER Short Machine Taps Set M 3 - M 12

HSSG Short Machine Taps (3 pcs. each dimension)

incl. HSS drill bits for core holes



through- & blind holes up to 2 x D



Chip removal (like picture)



Form C straight flutes



2-3 threads

TOL

ISO2/6H

Set Content

BAER HSSG Short Machine Taps	M 3 x 0,5 M 4 x 0,7 M 5 x 0,8 M 6 x 1,0 M 8 x 1,25 M 10 x 1,5 M 12 x 1,75
------------------------------	---

BAER HSSG Drill bits for core holes	2,5 mm 3,3 mm 4,2 mm 5,0 mm 6,8 mm 8,5 mm 10,2 mm
-------------------------------------	--

BAER Machine Taps Set M 3 - M 12

HSSE Machine Taps for through hole

incl. HSS Drill bits for core holes



through holes up to 4 x D



Chip removal (like picture)



Form B with spiral point



4-5 threads

TOL

ISO2/6H

Set Content

BAER HSSE Machine Taps through hole	M 3 x 0,5 M 4 x 0,7 M 5 x 0,8 M 6 x 1,0 M 8 x 1,25 M 10 x 1,5 M 12 x 1,75
-------------------------------------	---

BAER HSSG Drill bits for core holes	2,5 mm 3,3 mm 4,2 mm 5,0 mm 6,8 mm 8,5 mm 10,2 mm
-------------------------------------	--

78,70 €

Item No.: B1933E

net prices without VAT or tax



M

Metric coarse thread / ISO DIN 13

90,25 €

Item No.:
B1935E

net prices without VAT or tax



BAER Machine Taps Set M 3 - M 12

HSSE Machine Taps for blind holes
incl. HSS Drill bits for core holes



blind holes
up to 3 x D



Chip removal
(like picture)



Form C with
right spiral
flutes



2-3 threads

TOL



ISO2/6H

Set Content

BAER HSSE Machine Taps for blind holes	M 3 x 0,5 M 4 x 0,7 M 5 x 0,8 M 6 x 1,0 M 8 x 1,25 M 10 x 1,5 M 12 x 1,75
--	---

BAER HSSG Drill bits for core holes	2,5 mm 3,3 mm 4,2 mm 5,0 mm 6,8 mm 8,5 mm 10,2 mm
--	--

BAER Machine Taps Set M 3 - M 12

HSSE-TIN Machine Taps for through hole
incl. HSS-TIN Drill bits for core holes



through- &
blind holes
up to 4 x D



chip removal
(like picture)



Form B with
spiral point



4-5 threads

TOL



ISO2/6H

Set Content

BAER HSSE-TIN Machine Taps through hole	M 3 x 0,5 M 4 x 0,7 M 5 x 0,8 M 6 x 1,0 M 8 x 1,25 M 10 x 1,5 M 12 x 1,75
---	---

BAER HSSG-TIN Drill bits for core holes	2,5 mm 3,3 mm 4,2 mm 5,0 mm 6,8 mm 8,5 mm 10,2 mm
--	--

131,18 €

Item No.:
B1932

net prices without VAT or tax



134,33 €

Item No.:
B1934

net prices without VAT or tax



BAER Machine Taps Set M 3 - M 12

HSSE-TIN Machine Taps for through hole
incl. HSS-TIN Drill bits for core holes



blind holes
up to 3 x D



Chip removal
(like picture)



Form B with
spiral point



2-3 threads

TOL



ISO2/6H

Set Content

BAER HSSE Machine Taps for blind holes	M 3 x 0,5 M 4 x 0,7 M 5 x 0,8 M 6 x 1,0 M 8 x 1,25 M 10 x 1,5 M 12 x 1,75
--	---

BAER HSSG Drill bits for core holes	2,5 mm 3,3 mm 4,2 mm 5,0 mm 6,8 mm 8,5 mm 10,2 mm
--	--

M metric coarse thread / ISO DIN 13

BAER Machine Taps Set M 3 - M 12 for stainless steel

HSSE Machine Taps for through hole
incl. HSSE/Co Extreme drill bits for core holes



through holes
up to 4 x D



chip removal
(like picture)



Form B with
spiral point



4-5 threads

TOL



ISO2/6H

131,19 €

Item No.:
B1931

net prices without VAT or tax



Set Content

BAER HSSE Stainless steel Machine Taps through hole	M 3 x 0,5 M 4 x 0,7 M 5 x 0,8 M 6 x 1,0 M 8 x 1,25 M 10 x 1,5 M 12 x 1,75
BAER HSSE/Co Extreme drill bits for core holes	2,5 mm 3,3 mm 4,2 mm 5,0 mm 6,8 mm 8,5 mm 10,2 mm

156,37 €

Item No.:
B1930

net prices without VAT or tax



BAER Machine Taps Set M 3 - M 12 for stainless steel

HSSE Machine Taps for blind holes
incl. HSSE/Co Extreme drill bits for core holes



blind holes
up to 3 x D



Chip removal
(like picture)



Form C with
right spiral
flutes



2-3 threads

TOL



ISO2/6H

Set Content

BAER HSSE Stainless steel Machine Taps for blind holes	M 3 x 0,5 M 4 x 0,7 M 5 x 0,8 M 6 x 1,0 M 8 x 1,25 M 10 x 1,5 M 12 x 1,75
BAER HSSE/Co Extreme drill bits for core holes	2,5 mm 3,3 mm 4,2 mm 5,0 mm 6,8 mm 8,5 mm 10,2 mm

BAER Machine Taps Set M 3 - M 12 Left Hand

HSSE Machine Taps for through hole
incl. HSS Drill bits for core holes



through holes
up to 4 x D



Chip removal
(like picture)



Form B with
spiral point



4-5 threads

TOL



ISO2/6H

171,15 €

Item No.:
B1936E

net prices without VAT or tax



Set Content

BAER HSSE Left Machine Taps through hole	M 3 x 0,5 M 4 x 0,7 M 5 x 0,8 M 6 x 1,0 M 8 x 1,25 M 10 x 1,5 M 12 x 1,75
BAER HSSG Drill bits for core holes	2,5 mm 3,3 mm 4,2 mm 5,0 mm 6,8 mm 8,5 mm 10,2 mm

M

Metric coarse thread / ISO DIN 13

179,55 €

Item No.:
B1937E

net prices without VAT or tax



BAER Machine Taps Set M 3 - M 12 Left Hand

HSSE Machine Taps for blind holes
incl. HSS Drill bits for core holes



blind holes
up to 3 x D



Chip removal
(like picture)



Form C with
right spiral
flutes



2-3 threads

TOL



ISO2/6H

Set Content

BAER HSSE Left Machine Taps for blind holes	M 3 x 0,5 M 4 x 0,7 M 5 x 0,8 M 6 x 1,0 M 8 x 1,25 M 10 x 1,5 M 12 x 1,75
BAER HSSG Drill bits for core holes	2,5 mm 3,3 mm 4,2 mm 5,0 mm 6,8 mm 8,5 mm 10,2 mm

BAER Bit Short Machine Taps Set M 3 - M 10

HSSG-Bit Taps
incl. Bit-Adapter



through- &
blind holes
up to 2 x D



Chip removal
(like picture)



Form D
straight
flutes



3-4 threads

TOL



ISO2/6H

Set Content

BAER HSSG-Bit Short Machine Taps	M 3 x 0,5 M 4 x 0,7 M 5 x 0,8 M 6 x 1,0 M 8 x 1,25 M 10 x 1,5
1/4" Hexagonal-Bit-Adapter	



44,10 €

Item No.:
B1938

net prices without VAT or tax

53,10 €

Item No.:
B1939

net prices without VAT or tax



BAER Combined Bit Taps Set M 3 - M 10

HSSG-Combined Bit Taps
incl. Bit-Adapter



through hole
up to 1 x D



Chip removal
(like picture)

TOL



ISO2/6H

Set Content

BAER HSSG-Combined Bit-Taps	M 3 x 0,5 M 4 x 0,7 M 5 x 0,8 M 6 x 1,0 M 8 x 1,25 M 10 x 1,5
--------------------------------	--

1/4" Hexagonal-Bit-Adapter

M metric coarse thread / ISO DIN 13

BAER Taps and Dies Sets M 3 - M 12
(example picture)



BAER UNITap Set M 3 - M 12
HSSE UNITap Machine Taps through hole & blind hole
HSSE Round Dies

UNITAP

507,15
€/Set

BAER UNITap HSSE Machine Taps for through hole (up to 4 x D)	M 3 x 0,5 M 4 x 0,7 M 5 x 0,8 M 6 x 1,0 M 8 x 1,25 M 10 x 1,5 M 12 x 1,75
BAER UNITap HSSE Machine Taps for through hole (up to 4 x D)	M 3 x 0,5 M 4 x 0,7 M 5 x 0,8 M 6 x 1,0 M 8 x 1,25 M 10 x 1,5 M 12 x 1,75
BAER HSSE Round Dies with spiral entry	M 3 x 0,5 M 4 x 0,7 M 5 x 0,8 M 6 x 1,0 M 8 x 1,25 M 10 x 1,5 M 12 x 1,75

No.:
BB12U

BAER Set M 3 - M 12
HSSE Machine Taps & Drill bits for core holes
HSS Round Dies

148,13
€/Set

BAER HSSE Machine Taps Form C for through hole & blind hole (up to 2 x D)	M 3 x 0,5 M 4 x 0,7 M 5 x 0,8 M 6 x 1,0 M 8 x 1,25 M 10 x 1,5 M 12 x 1,75
BAER HSSG Drill bits for core holes	2,5 mm 3,3 mm 4,2 mm 5,0 mm 6,8 mm 8,5 mm 10,2 mm
BAER HSS Round Dies	M 3 x 0,5 M 4 x 0,7 M 5 x 0,8 M 6 x 1,0 M 8 x 1,25 M 10 x 1,5 M 12 x 1,75

No.:
BB2E

BAER Set M 3 - M 12
HSSE Machine Taps through hole & blind hole
HSS Round Dies

223,00
€/Set

BAER HSSE Machine Taps Form B with spiral point for through hole (up to 4 x D)	M 3 x 0,5 M 4 x 0,7 M 5 x 0,8 M 6 x 1,0 M 8 x 1,25 M 10 x 1,5 M 12 x 1,75
BAER HSSE Machine Taps Form C with right spiral flutes for blind holes (up to 3 x D)	M 3 x 0,5 M 4 x 0,7 M 5 x 0,8 M 6 x 1,0 M 8 x 1,25 M 10 x 1,5 M 12 x 1,75
BAER HSS Round Dies	M 3 x 0,5 M 4 x 0,7 M 5 x 0,8 M 6 x 1,0 M 8 x 1,25 M 10 x 1,5 M 12 x 1,75

No.:
BB1E

BAER Left Hand Set M 3 - M 12
HSSE Left Hand Machine Taps & Drill bits for core holes
HSS Left Hand Round Dies

215,11
€/Set

BAER HSSE Machine Taps Left Form C for through hole & blind hole (up to 2 x D)	M 3 x 0,5 M 4 x 0,7 M 5 x 0,8 M 6 x 1,0 M 8 x 1,25 M 10 x 1,5 M 12 x 1,75
BAER HSSG Drill bits for core holes	2,5 mm 3,3 mm 4,2 mm 5,0 mm 6,8 mm 8,5 mm 10,2 mm
BAER HSS Round Dies Left	M 3 x 0,5 M 4 x 0,7 M 5 x 0,8 M 6 x 1,0 M 8 x 1,25 M 10 x 1,5 M 12 x 1,75

No.:
BB7E

BAER TIN Set M 3 - M 12
HSSE-TIN Machine Taps through hole & blind hole
HSS Round Dies

276,71
€/Set

BAER HSSE-TIN Machine Taps Form B with spiral point for through hole (up to 4 x D)	M 3 x 0,5 M 4 x 0,7 M 5 x 0,8 M 6 x 1,0 M 8 x 1,25 M 10 x 1,5 M 12 x 1,75
BAER HSSE-TIN Machine Taps Form C with right spiral flutes for blind holes (up to 3 x D)	M 3 x 0,5 M 4 x 0,7 M 5 x 0,8 M 6 x 1,0 M 8 x 1,25 M 10 x 1,5 M 12 x 1,75
BAER HSS Round Dies	M 3 x 0,5 M 4 x 0,7 M 5 x 0,8 M 6 x 1,0 M 8 x 1,25 M 10 x 1,5 M 12 x 1,75

No.:
BB4

BAER Stainless steel Set M 3 - M 12
HSSE-Stainless steel Machine Taps through hole & blind hole
HSSE-Stainless steel Round Dies

314,66
€/Set

BAER HSSE Stainless steel Machine Taps for through hole (up to 4 x D)	M 3 x 0,5 M 4 x 0,7 M 5 x 0,8 M 6 x 1,0 M 8 x 1,25 M 10 x 1,5 M 12 x 1,75
BAER HSSE Stainless steel Machine Taps for blind holes (up to 3 x D)	M 3 x 0,5 M 4 x 0,7 M 5 x 0,8 M 6 x 1,0 M 8 x 1,25 M 10 x 1,5 M 12 x 1,75
BAER HSSE Stainless steel Round Dies	M 3 x 0,5 M 4 x 0,7 M 5 x 0,8 M 6 x 1,0 M 8 x 1,25 M 10 x 1,5 M 12 x 1,75

No.:
BB9

BAER ULTRA Threading Tools Set



through- & blind holes up to 2 x D



Chip removal (like picture)



Form C straight flutes



2-3 threads

TOL

ISO2/6H

Set Content M 3 - M 12

BAER Ultra Hand Tap Sets (3 parts)	M 3 x 0,5 M 4 x 0,7 M 5 x 0,8 M 6 x 1,0 M 8 x 1,25 M 10 x 1,5 M 12 x 1,75
BAER Round Dies acc. to DIN	M 3 x 0,5 M 4 x 0,7 M 5 x 0,8 M 6 x 1,0 M 8 x 1,25 M 10 x 1,5 M 12 x 1,75
BAER HSSG Drill bits for core holes	2,5 mm 3,3 mm 4,2 mm 5,0 mm 6,8 mm 8,5 mm 10,2 mm
BAER PRO adjustable Tap Wrenches	No. 1: M 1-10 1/16-3/8 G 1/8 No. 2: M 4-12 5/32-1/2 G 1/8
BAER PRO Die Stocks	20 x 5 20 x 7 25 x 9 30 x 11 38 x 14
BAER Tap Holder Ratchet	M 3-10 M 5-12
BAER PRO Die Guides	M 3 x 0,5 M 4 x 0,7 M 5 x 0,8 M 6 x 1,0 M 8 x 1,25 M 10 x 1,5 M 12 x 1,75
BAER Cutting Paste	100 ml
Thread pitch gauge	for metric threads
Screw extractor	

* contains HSSE Drill bits

M 3 - 12

416,80 €

Item No.: BU312



HSSG Hand Tap Sets: taper tap with pilot nose



HSS Round Dies acc. to DIN 223

M 3 - 12 stainless steels*

573,90 €

Item No.: BU312VA



HSSE-VAP Hand Tap Sets: taper tap with pilot nose



HSSE-NT Round Dies acc. to DIN 223

BAER Short Machine Taps Set M 3 - M 12

HSSG Short Machine Taps incl. HSS drill bits for core holes and tap wrench in metal box



through- & blind holes up to 2 x D



Chip removal (like picture)



Form C straight flutes



2-3 threads

TOL

ISO2/6H

Set Content

BAER HSSG Short Machine Taps	M 3 x 0,5 M 4 x 0,7 M 5 x 0,8 M 6 x 1,0 M 8 x 1,25 M 10 x 1,5 M 12 x 1,75
BAER HSSG Drill bits for core holes	2,5 mm 3,3 mm 4,2 mm 5,0 mm 6,8 mm 8,5 mm 10,2 mm
BAER adjustable Tap Wrenches - zinc die cast	M 1-12 1/16-1/2 G 1/8

44,00 €

Item No.: B1928M

net prices without VAT or tax



M metric coarse thread / ISO DIN 13

BAER Hand-Tap Sets, Round Dies and Tools Set



through- & blind holes up to 2 x D



Chip removal (like picture)



Form C straight flutes



2-3 threads

TOL

ISO2/6H

Set Content M 3 - M 12

BAER HSSG Hand Tap Sets (3 parts) M 3 x 0,5 | M 4 x 0,7 | M 5 x 0,8 | M 6 x 1,0
M 8 x 1,25 | M 10 x 1,5 | M 12 x 1,75

BAER HSS Round Dies acc. to DIN M 3 x 0,5 | M 4 x 0,7 | M 5 x 0,8 | M 6 x 1,0
M 8 x 1,25 | M 10 x 1,5 | M 12 x 1,75

BAER adjustable Tap Wrench No. 1.1/2: M 1-12 | 1/16-1/2 | G 1/8

BAER Die Stock 25 x 9

Thread pitch gauge for metric threads

Screw extractor

99,25 €

Item No.: BMK312

net prices without VAT or tax



Drill Bit Sets



Wood drill set Ø 3 - 10 mm (15 pieces)

Set Content

3 x 3 mm | 2 x 3,5 mm | 2 x 4 mm | 1 x 4,5 mm
1 x 5 mm | 1 x 5,5 mm | 1 x 6 mm | 1 x 6,5 mm
1 x 7 mm | 1 x 8 mm | 1 x 10 mm

17,10 €

Item No.: BW0001

net prices without VAT or tax



Concrete- & masonry drill bit set Ø 3 - 10 mm (15 pieces)

Set Content

3 x 3 mm | 3 x 4 mm | 3 x 5 mm
2 x 6 mm | 2 x 8 mm | 2 x 10 mm

18,40 €

Item No.: BS0001

net prices without VAT or tax



SDS-Plus Hammer Drill Set Ø 5 - 12 mm (7 pieces) - 160mm

Set Content

1 x 5 mm | 2 x 6 mm | 2 x 8 mm
1 x 10 mm | 1 x 12 mm

37,70 €

Item No.: BS0002

net prices without VAT or tax

M

Metric coarse thread / ISO DIN 13



**M 3 - 12
Standard**

254,29 €

Item No.:
10360009046

**M 3 - 12
Left**

309,59 €

Item No.:
10360009046LH

**M 3 - 12
stainless
steels***

483,00 €

Item No.:
10360009046VA

* contains HSSE Taps and Dies

BAER Hand-Tap Sets, Round Dies and Tools Sets



through- &
blind holes
up to 2 x D



Chip removal
(like picture)



Form C
straight
flutes



2-3 threads

TOL



ISO2/6H

Set Content M 3 - M 12

BAER HSSG Hand Tap Sets (3 parts)	M 3 x 0,5 M 4 x 0,7 M 5 x 0,8 M 6 x 1,0 M 8 x 1,25 M 10 x 1,5 M 12 x 1,75
BAER HSS Round Dies acc. to DIN	M 3 x 0,5 M 4 x 0,7 M 5 x 0,8 M 6 x 1,0 M 8 x 1,25 M 10 x 1,5 M 12 x 1,75
BAER HSSG Drill bits for core holes	2,5 mm 3,3 mm 4,2 mm 5,0 mm 6,8 mm 8,5 mm 10,2 mm
BAER adjustable Tap Wrenches	M 1-10 1/16-3/8 G 1/8 M 4-12 5/32-1/2 G 1/8
BAER Die Stocks	20 x 5 20 x 7 25 x 9 30 x 11 38 x 14
BAER Tap Holder Ratchet	M 3-10 M 5-12
Thread pitch gauge	for metric threads
Screw extractor	

Set Content M 3 - M 20

BAER HSSG Hand Tap Sets (3 parts)	M 3 x 0,5 M 4 x 0,7 M 5 x 0,8 M 6 x 1,0 M 8 x 1,25 M 10 x 1,5 M 12 x 1,75 M 14 x 2,0 M 16 x 2,0 M 18 x 2,5 M 20 x 2,5
BAER HSS Round Dies acc. to DIN	M 3 x 0,5 M 4 x 0,7 M 5 x 0,8 M 6 x 1,0 M 8 x 1,25 M 10 x 1,5 M 12 x 1,75 M 14 x 2,0 M 16 x 2,0 M 18 x 2,5 M 20 x 2,5
BAER adjustable Tap Wrenches	M 1-10 1/16-3/8 G 1/8 M 5-20 7/32-3/4 G 1/8-G 1/2
BAER Die Stocks	20 x 5 20 x 7 25 x 9 30 x 11 38 x 14 45 x 18
BAER Tap Holder Ratchet	M 3-10 M 5-12
BAER Tap Holder Ratchet	M 3-10 M 5-12
Thread pitch gauge	for metric threads
Screw extractor	



**M 3 - 20
Standard**

403,71 €

Item No.:
10360009146

**M 3 - 20
Left**

634,93 €

Item No.:
10360009146LH

**M 3 - 20
stainless
steels***

1.047,38 €

Item No.:
10360009146VA

* contains HSSE Taps and Dies

M metric coarse thread / ISO DIN 13

BAER Hand-Tap Sets, Round Dies and Tools Sets (example picture)



BAER Set M 3 - M 12 (incl. intermediate sizes) HSSG Hand Tap Sets & HSS Round Dies & Tools

BAER HSSG Hand Tap Sets (3 parts)	M 3 x 0,5 M 4 x 0,7 M 5 x 0,8 M 6 x 1,0 M 7 x 1,0 M 8 x 1,25 M 9 x 1,25 M 10 x 1,5 M 11 x 1,5 M 12 x 1,75
BAER HSS Round Dies	M 3 x 0,5 M 4 x 0,7 M 5 x 0,8 M 6 x 1,0 M 7 x 1,0 M 8 x 1,25 M 9 x 1,25 M 10 x 1,5 M 11 x 1,5 M 12 x 1,75
BAER adjustable Tap Wrenches - zinc die cast	M 1-10 1/16-3/8 G 1/8 & M 4-12 5/32-1/2 G 1/8
BAER Die Stocks - zinc die cast	20 x 5 20 x 7 25 x 9 30 x 11 38 x 14
Screw extractor	

403,24
€/Set

No.:
264800301

BAER Set M 5 - M 12 (incl. intermediate sizes) HSSG Hand Tap Sets & HSS Round Dies & Tools

BAER HSSG Hand Tap Sets (3 parts)	M 5 x 0,8 M 6 x 1,0 M 7 x 1,0 M 8 x 1,25 M 9 x 1,25 M 10 x 1,5 M 11 x 1,5 M 12 x 1,75
BAER HSS Round Dies	M 5 x 0,8 M 6 x 1,0 M 7 x 1,0 M 8 x 1,25 M 9 x 1,25 M 10 x 1,5 M 11 x 1,5 M 12 x 1,75
BAER adjustable Tap Wrenches - zinc die cast	M 1-10 1/16-3/8 G 1/8 & M 4-12 5/32-1/2 G 1/8
BAER Die Stocks - zinc die cast	20 x 7 25 x 9 30 x 11 38 x 14
Screw extractor	

368,67
€/Set

No.:
264800401

BAER Set M 5 - M 20 (incl. intermediate sizes) HSSG Hand Tap Sets & HSS Round Dies & Tools

BAER HSSG Hand Tap Sets (3 parts)	M 5 x 0,8 M 6 x 1,0 M 7 x 1,0 M 8 x 1,25 M 9 x 1,25 M 10 x 1,5 M 11 x 1,5 M 12 x 1,75 M 14 x 2,0 M 16 x 2,0 M 18 x 2,5 M 20 x 2,5
BAER HSS Round Dies	M 5 x 0,8 M 6 x 1,0 M 7 x 1,0 M 8 x 1,25 M 9 x 1,25 M 10 x 1,5 M 11 x 1,5 M 12 x 1,75 M 14 x 2,0 M 16 x 2,0 M 18 x 2,5 M 20 x 2,5
BAER adjustable Tap Wrenches - zinc die cast	M 1-10 1/16-3/8 G 1/8 & M 5-20 7/32-3/4 G 1/8-G 1/2
BAER Die Stocks - zinc die cast	20 x 7 25 x 9 30 x 11 38 x 14 45 x 18
Screw extractor	

622,14
€/Set

No.:
264800501

BAER Set M 3 - M 24 HSSG Hand Tap Sets & HSS Round Dies & Tools

BAER HSSG Hand Tap Sets (3 parts)	M 3 x 0,5 M 4 x 0,7 M 5 x 0,8 M 6 x 1,0 M 8 x 1,25 M 10 x 1,5 M 12 x 1,75 M 14 x 2,0 M 16 x 2,0 M 18 x 2,5 M 20 x 2,5 M 22 x 2,5 M 24 x 3,0
BAER HSS Round Dies	M 3 x 0,5 M 4 x 0,7 M 5 x 0,8 M 6 x 1,0 M 8 x 1,25 M 10 x 1,5 M 12 x 1,75 M 14 x 2,0 M 16 x 2,0 M 18 x 2,5 M 20 x 2,5 M 22 x 2,5 M 24 x 3,0
BAER adjustable Tap Wrenches - zinc die cast	M 1-10 1/16-3/8 G 1/8 & M 11-27 7/16-1" G 1/4-G 3/4
BAER Die Stocks - zinc die cast	20 x 5 20 x 7 25 x 9 30 x 11 38 x 14 45 x 18 55 x 22
Screw extractor	

794,95
€/Set

No.:
264800601

BAER Set M 5 - M 30 HSSG Hand Tap Sets & HSS Round Dies & Tools

BAER HSSG Hand Tap Sets (3 parts)	M 5 x 0,8 M 6 x 1,0 M 8 x 1,25 M 10 x 1,5 M 12 x 1,75 M 14 x 2,0 M 16 x 2,0 M 18 x 2,5 M 20 x 2,5 M 22 x 2,5 M 24 x 3,0 M 27 x 3,0 M 30 x 3,5
BAER HSS Round Dies	M 5 x 0,8 M 6 x 1,0 M 8 x 1,25 M 10 x 1,5 M 12 x 1,75 M 14 x 2,0 M 16 x 2,0 M 18 x 2,5 M 20 x 2,5 M 22 x 2,5 M 24 x 3,0 M 27 x 3,0 M 30 x 3,5
BAER adjustable Tap Wrenches - zinc die cast	M 1-10 1/16-3/8 G 1/8 & M 5-20 7/32-3/4" G 1/8-G 1/2 & M 13-32 1/2-1.1/4" G 1/4-1"
BAER Die Stocks - zinc die cast	20 x 7 25 x 9 30 x 11 38 x 14 45 x 18 55 x 22 65 x 25
Screw extractor	

1.461,08
€/Set

No.:
264800701

- ✓ Efficient internal thread cutting.
- ✓ The short structural type makes that tap usable by machine and hand.

Application:

- ⚙ non abrasive material up to 900 N/mm²
- ⚙ unalloyed and low alloyed steel

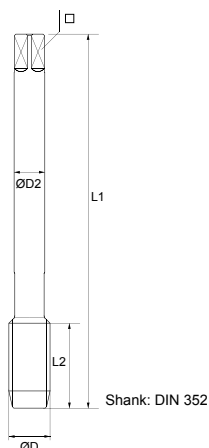

Short Machine Taps Form D for through holes and blind holes

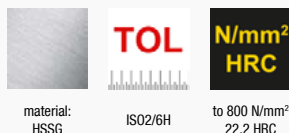
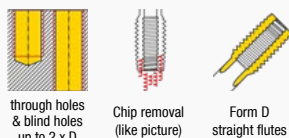

Short Machine Taps Form B for through holes

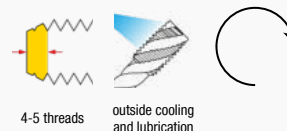
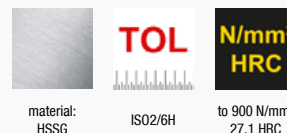
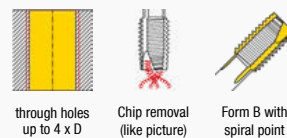

M	D1	D2	L1	L2	□		No.	€	No.	€
M 2 x 0,4	2,0	2,8	36	8	2,1	1,60	110101001	7,50	110201001	7,33
M 2,5 x 0,45	2,5	2,8	40	9	2,1	2,05	110101002	7,50	110201002	7,33
M 3 x 0,5	3,0	3,5	40	11	2,7	2,50	110101003	4,04	110201003	4,29
M 3,5 x 0,6	3,5	4,0	45	13	3,0	2,90	110101004	4,45	110201004	4,50
M 4 x 0,7	4,0	4,5	45	13	3,4	3,30	110101005	4,04	110201005	4,29
M 5 x 0,8	5,0	6,0	50	16	4,9	4,20	110101006	4,16	110201006	4,61
M 6 x 1,0	6,0	6,0	50	19	4,9	5,00	110101007	4,50	110201007	4,71
M 8 x 1,25	8,0	6,0	56	22	4,9	6,80	110101008	5,76	110201008	6,18
M 10 x 1,5	10,0	7,0	70	24	5,5	8,50	110101009	6,74	110201009	7,54
M 12 x 1,75	12,0	9,0	75	29	7,0	10,20	110101010	9,52	110201010	10,58
M 14 x 2,0	14,0	11,0	80	30	9,0	12,00	110101011	11,71	110201011	13,83
M 16 x 2,0	16,0	12,0	80	32	9,0	14,00	110101012	16,01	110201012	16,76
M 18 x 2,5	18,0	14,0	95	40	11,0	15,50	110101013	20,21	110201013	23,98
M 20 x 2,5	20,0	16,0	95	40	12,0	17,50	110101014	22,18	110201014	27,02
M 22 x 2,5	22,0	18,0	100	40	14,5	19,50	110101015	30,93	110201015	31,94
M 24 x 3,0	24,0	18,0	110	50	14,5	21,00	110101016	36,38	110201016	36,45
M 27 x 3,0	27,0	20,0	110	50	16,0	24,00	110101017	46,99	110201017	50,90
M 30 x 3,5	30,0	22,0	125	56	18,0	26,50	110101018	65,84	110201018	67,87

M metric coarse thread / ISO DIN 13

- Efficient internal thread cutting.
- The short structural type makes that tap usable by hand.

A Hand-Tap-Set includes 3 taps:

- Taper Tap
- Intermediate Tap
- Finish Tap

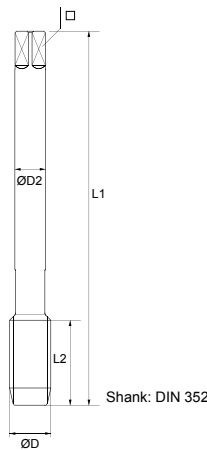

Hand Tap Sets for general use

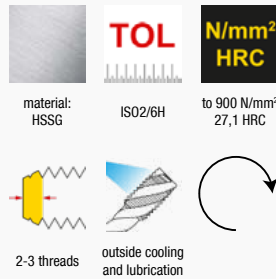
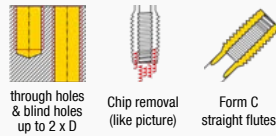

Hand Tap Sets for general use Left Hand

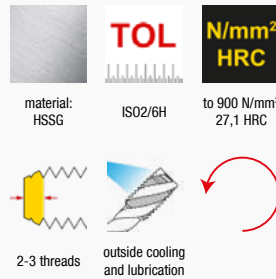
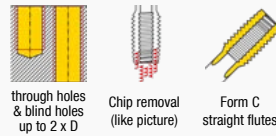

Hand Tap Sets for stainless steels

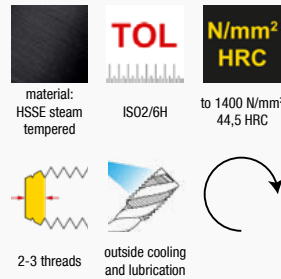
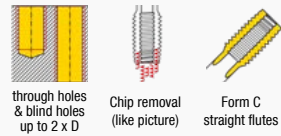

M	D1	D2	L1	L2	□	🔩	No.	€	No.	€	No.	€
M 1 x 0,25	1,0	2,5	32	6	2,1	0,75	110301001	20,74				
M 1,1 x 0,25	1,1	2,5	32	6	2,1	0,85	110301002	20,74				
M 1,2 x 0,25	1,2	2,5	32	6	2,1	0,95	110301003	20,74				
M 1,4 x 0,3	1,4	2,5	32	7	2,1	1,10	110301004	20,74				
M 1,6 x 0,35	1,6	2,5	32	8	2,1	1,25	110301005	20,74				
M 1,7 x 0,35	1,7	2,5	32	8	2,1	1,30	110301006	20,74				
M 1,8 x 0,35	1,8	2,5	32	8	2,1	1,45	110301007	20,74				
M 2 x 0,4	2,0	2,8	36	8	2,1	1,60	110301008	14,77				
M 2,2 x 0,45	2,2	2,8	36	9	2,1	1,75	110301009	14,77				
M 2,3 x 0,4	2,3	2,8	36	9	2,1	1,90	110301010	14,77				
M 2,5 x 0,45	2,5	2,8	40	9	2,1	2,05	110301011	14,77				
M 2,6 x 0,45	2,6	2,8	40	9	2,1	2,10	110301012	14,77				
M 3 x 0,5	3,0	3,5	40	11	2,7	2,50	110301013	7,54	110302001	13,22	110305001	26,13
M 3 x 0,6 *	3,0	3,5	40	11	2,7	2,40	110301014	11,00				
M 3,5 x 0,6	3,5	4,0	45	13	3,0	2,90	110301015	11,00				
M 3,5 x 0,75 *	3,5	4,0	45	13	3,0	2,75	110301016	206,17				
M 4 x 0,7	4,0	4,5	45	13	3,4	3,30	110301017	7,54	110302002	13,22	110305002	26,45
M 4 x 0,75	4,0	4,5	45	13	3,4	3,25	110301018	11,00				
M 4,5 x 0,75	4,5	6,0	50	16	4,9	3,70	110301019	11,00				
M 5 x 0,8	5,0	6,0	50	16	4,9	4,20	110301020	8,48	110302003	15,11	110305003	28,02
M 5 x 0,9 *	5,0	6,0	50	16	4,9	4,10	110301021	11,00				
M 5,5 x 0,9	5,5	6,0	50	18	4,9	4,60	110301022	13,83				
M 6 x 1,0	6,0	6,0	50	19	4,9	5,00	110301023	8,48	110302004	15,74	110305004	28,02
M 7 x 1,0	7,0	6,0	50	19	4,9	6,00	110301024	13,83				
M 8 x 1,25	8,0	6,0	56	22	4,9	6,80	110301025	11,00	110302005	17,95	110305005	38,10
M 9 x 1,25	9,0	7,0	63	22	5,5	7,80	110301026	18,54				
M 10 x 1,5	10,0	7,0	70	24	5,5	8,50	110301027	14,45	110302006	24,56	110305006	49,75
M 11 x 1,5	11,0	8,0	70	24	6,2	9,50	110301028	23,57				
M 12 x 1,75	12,0	9,0	75	29	7,0	10,20	110301029	18,85	110302007	32,11	110305007	61,71
M 14 x 2,0	14,0	11,0	80	30	9,0	12,00	110301030	21,68	110302008	35,58		

* special pitch

M

metric coarse thread / ISO DIN 13

- Efficient internal thread cutting.
- The short structural type makes that tap usable by hand.

A Hand-Tap-Set includes 3 taps:

- Taper Tap
- Intermediate Tap
- Finish Tap

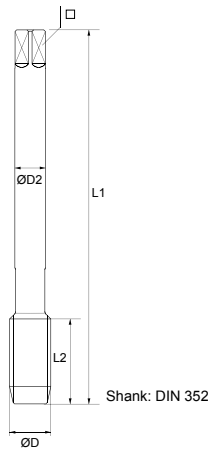

Hand Tap Sets for general use

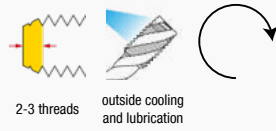
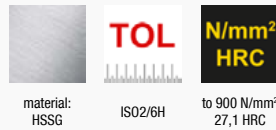
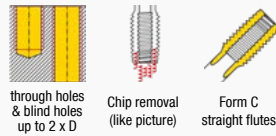

Hand Tap Sets for general use Left Hand

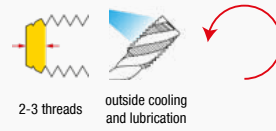
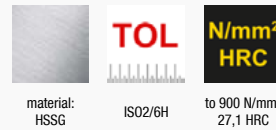
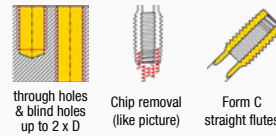

Hand Tap Sets for stainless steels

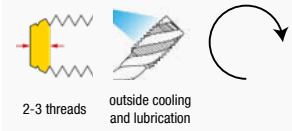
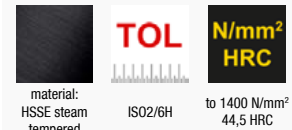
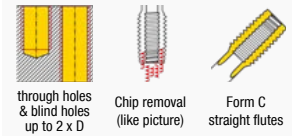

M

	D1	D2	L1	L2	□		No.	€	No.	€	No.	€
M 15 x 2,0	15,0	12,0	80	32	9,0	13,00	110301031	25,77				
M 16 x 2,0	16,0	12,0	80	32	9,0	14,00	110301032	27,02	110302009	44,39		
M 18 x 2,5	18,0	14,0	95	40	11,0	15,50	110301033	35,51	110302010	57,62		
M 20 x 2,5	20,0	16,0	95	40	12,0	17,50	110301034	40,85	110302011	64,54		
M 22 x 2,5	22,0	18,0	100	40	14,5	19,50	110301035	50,59	110302012	78,71		
M 24 x 3,0	24,0	18,0	110	50	14,5	21,00	110301036	62,84	110302013	110,19		
M 27 x 3,0	27,0	20,0	110	50	16,0	24,00	110301037	97,41	110302014	176,31		
M 30 x 3,5	30,0	22,0	125	56	18,0	26,50	110301038	131,97	110302015	214,09		
M 33 x 3,5	33,0	25,0	125	56	20,0	29,50	110301039	169,67	110302016	264,47		
M 36 x 4,0	36,0	28,0	150	63	22,0	32,00	110301040	201,09	110302017	317,99		
M 39 x 4,0	39,0	32,0	150	63	24,0	35,00	110301041	257,65	110302018	409,29		
M 42 x 4,5	42,0	32,0	150	63	24,0	37,50	110301042	289,07	110302019	462,82		
M 45 x 4,5	45,0	36,0	160	70	29,0	40,50	110301043	351,92	110302020	557,27		
M 48 x 5,0	48,0	36,0	180	75	29,0	43,00	110301044	493,31	110302021	790,25		
M 52 x 5,0	52,0	40,0	180	75	32,0	47,00	110301045	493,31	110302022	790,25		
M 56 x 5,5	56,0	45,0	200	85	35,0	50,50	110301046	637,85				
M 60 x 5,5	60,0	45,0	200	85	35,0	54,50	110301047	848,37				
M 64 x 6,0	64,0	50,0	220	90	39,0	58,00	110301048	942,63				
M 68 x 6,0	68,0	50,0	220	90	39,0	62,00	110301049	1.178,29				
M 72 x 6,0	72,0	50,0	240	80	39,0	66,00	110301050	2.388,00				
M 76 x 6,0	76,0	50,0	240	80	39,0	70,00	110301051	2.906,45				
M 80 x 6,0	80,0	50,0	260	85	39,0	74,00	110301052	3.204,95				
M 84 x 6,0	84,0	50,0	260	85	39,0	78,00	110301053	3.707,68				
M 88 x 6,0	88,0	50,0	260	85	39,0	82,00	110301054	4.901,68				
M 90 x 6,0	90,0	50,0	260	85	39,0	84,00	110301055	5.278,74				
M 92 x 6,0	92,0	56,0	280	90	44,0	86,00	110301056	5.655,79				
M 96 x 6,0	96,0	56,0	280	90	44,0	90,00	110301057	6.409,89				
M 100 x 6,0	100,0	56,0	280	90	44,0	94,00	110301058	7.164,00				

* special pitch

- ✓ Efficient internal thread cutting.
- ✓ The short structural type makes that tap usable by machine and hand.

A Hand-Tap-Set includes 3 taps:

- ⚙ Taper Tap
- ⚙ Intermediate Tap
- ⚙ Finish Tap

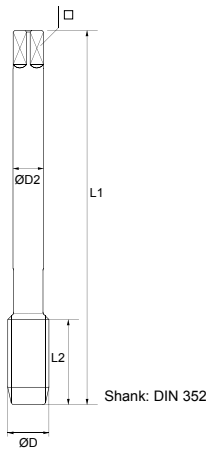

Hand Tap Sets with conical profile

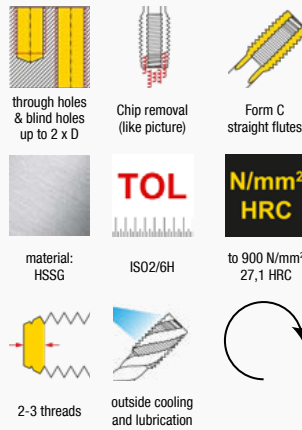

Hand Tap Sets HSSE for higher demands

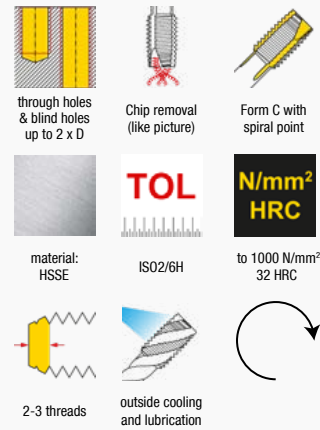

M

	D1	D2	L1	L2	□		No.	€	No.	€
M 2 x 0,4	2,0	2,8	36	8	2,1	1,60	110313001	14,80		
M 2,5 x 0,45	2,5	2,8	40	9	2,1	2,05	110313002	14,80		
M 3 x 0,5	3,0	3,5	40	11	2,7	2,50	110313003	7,56	110304001	14,48
M 4 x 0,7	4,0	4,5	45	13	3,4	3,30	110313004	7,56	110304002	14,80
M 5 x 0,8	5,0	6,0	50	16	4,9	4,20	110313005	8,50	110304003	15,43
M 6 x 1,0	6,0	6,0	50	19	4,9	5,00	110313006	8,50	110304004	15,43
M 8 x 1,25	8,0	6,0	56	22	4,9	6,80	110313007	11,02	110304005	21,09
M 9 x 1,25	9,0	7,0	63	22	5,5	7,80	110313008	18,58		
M 10 x 1,5	10,0	7,0	70	24	5,5	8,50	110313009	14,48	110304006	27,71
M 11 x 1,5	11,0	8,0	70	24	6,2	9,50	110313010	23,61		
M 12 x 1,75	12,0	9,0	75	29	7,0	10,20	110313011	18,89	110304007	34,32
M 13 x 1,75	12,0	9,0	75	29	7,0	11,20	110313012	26,13		
M 14 x 2,0	14,0	11,0	80	30	9,0	12,00	110313013	21,72	110304008	39,04
M 16 x 2,0	16,0	12,0	80	32	9,0	14,00	110313014	27,08	110304009	50,69
M 18 x 2,5	18,0	14,0	95	40	11,0	15,50	110313015	35,58	110304010	63,91
M 19 x 2,5	18,0	14,0	95	40	11,0	16,50	110313016	48,80		
M 20 x 2,5	20,0	16,0	95	40	12,0	17,50	110313017	40,93	110304011	73,99
M 22 x 2,5	22,0	18,0	100	40	14,5	19,50	110313018	50,69	110304012	89,42
M 24 x 3,0	24,0	18,0	110	50	14,5	21,00	110313019	62,97	110304013	111,14
M 27 x 3,0	27,0	20,0	110	50	16,0	24,00	110313020	97,60	110304014	168,44
M 30 x 3,5	30,0	22,0	125	56	18,0	26,50	110313021	132,23	110304015	229,21
M 33 x 3,5	33,0	25,0	125	56	20,0	29,50	110313022	170,01		
M 36 x 4,0	36,0	28,0	150	63	22,0	32,00	110313023	201,50		
M 39 x 4,0	39,0	32,0	150	63	24,0	35,00	110313024	258,17		
M 42 x 4,5	42,0	32,0	150	63	24,0	37,50	110313025	289,65		

M

metric coarse thread / ISO DIN 13

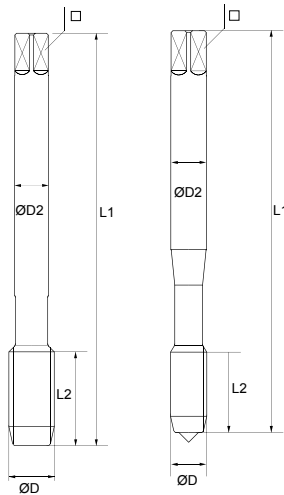
- Tap for machine use in through hole.
- The spiral point pushes the chips ahead.



Shank: DIN 376

Shank: DIN 371

Machine Tap for universal use

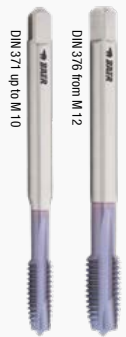
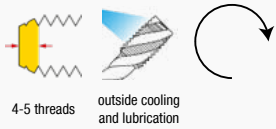
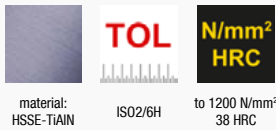
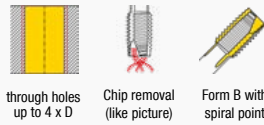
UNITAP

Machine Tap for general use

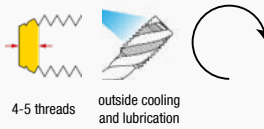
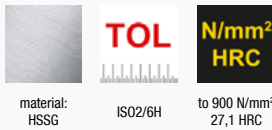
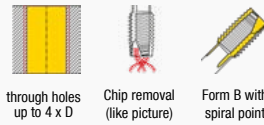

Machine Tap for general use Left-hand thread

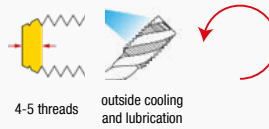
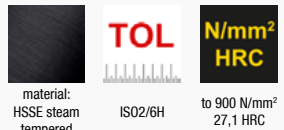
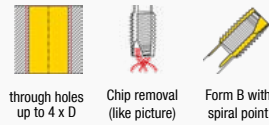

M	D1	D2	L1	L2	□	🔩	No.	€	No.	€	No.	€
DIN 371												
M 2 x 0,4	2,0	2,8	45	8	2,1	1,60	110403001	28,02	110401001	8,69		
M 2,2 x 0,45	2,2	2,8	45	8	2,1	1,75	110403002	31,13				
M 2,5 x 0,45	2,5	2,8	50	9	2,1	2,05	110403003	23,78	110401002	8,69		
M 3 x 0,5	3,0	3,5	56	11	2,7	2,50	110403004	18,17	110401003	6,60	110402001	13,83
M 3,5 x 0,6	3,5	4,0	56	13	3,0	2,90	110403005	21,53	110401004	7,33		
M 4 x 0,7	4,0	4,5	63	13	3,4	3,30	110403006	17,49	110401005	6,70	110402002	13,83
M 5 x 0,8	5,0	6,0	70	16	4,9	4,20	110403007	18,17	110401006	7,12	110402003	14,45
M 6 x 1,0	6,0	6,0	80	19	4,9	5,00	110403008	18,75	110401007	7,12	110402004	14,45
M 7 x 1,0	7,0	7,0	80	19	5,5	6,00			110401008	10,05	110402005	18,75
M 8 x 1,25	8,0	8,0	90	22	6,2	6,80	110403009	22,69	110401009	8,90	110402006	17,60
M 10 x 1,5	10,0	10,0	100	24	8,0	8,50	110403010	27,81	110401010	11,21	110402007	19,90
DIN 376												
M 3 x 0,5	3,0	2,2	56	11	-	2,50			110401011	7,12	110402008	13,83
M 4 x 0,7	4,0	2,8	63	13	2,1	3,30			110401012	7,12	110402009	13,83
M 5 x 0,8	5,0	3,5	70	16	2,7	4,20			110401013	7,75	110402010	14,45
M 6 x 1,0	6,0	4,5	80	19	3,4	5,00			110401014	7,75	110402011	14,45
M 8 x 1,25	8,0	6,0	90	22	4,9	6,80			110401015	9,53	110402012	17,60
M 10 x 1,5	10,0	7,0	100	24	5,5	8,50			110401016	11,42	110402013	19,90
M 12 x 1,75	12,0	9,0	110	29	7,0	10,20	110403011	33,71	110401017	13,41	110402014	25,03
M 14 x 2,0	14,0	11,0	110	30	9,0	12,00	110403012	48,78	110401018	16,97	110402015	31,74
M 16 x 2,0	16,0	12,0	110	32	9,0	14,00	110403013	61,14	110401019	19,27	110402016	36,76
M 18 x 2,5	18,0	14,0	125	34	11,0	15,50	110403014	77,21	110401020	27,76	110402017	49,96
M 20 x 2,5	20,0	16,0	140	34	12,0	17,50	110403015	91,77	110401021	35,82	110402018	70,70
M 22 x 2,5	22,0	18,0	140	34	14,5	19,50	110403016	118,23	110401022	46,50	110402019	77,92
M 24 x 3,0	24,0	18,0	160	38	14,5	21,00	110403017	124,73	110401023	49,02	110402020	84,21
M 27 x 3,0	27,0	20,0	160	38	16,0	24,00	110403018	199,02	110401024	81,69	110402021	138,25
M 30 x 3,5	30,0	22,0	180	45	18,0	26,50	110403019	240,94	110401025	84,21	110402022	144,54
M 33 x 3,5	33,0	25,0	180	50	20,0	29,50			110401026	118,14	110402023	196,91
M 36 x 4,0	36,0	28,0	200	56	22,0	32,00			110401027	192,30	110402024	328,87
M 39 x 4,0	39,0	32,0	200	60	24,0	35,00			110401028	247,60	110402025	412,66
M 42 x 4,5	42,0	32,0	200	60	24,0	37,50			110401029	289,07	110402026	490,17
M 45 x 4,5	45,0	36,0	220	65	29,0	40,50			110401030	326,78	110402027	540,44
M 48 x 5,0	48,0	36,0	250	70	29,0	43,00			110401031	358,20	110402028	597,00
M 52 x 5,0	52,0	40,0	250	70	32,0	47,00			110401032	437,38	110402029	706,97

M

metric coarse thread / ISO DIN 13

- ✓ Tap for machine use in through hole.
- ✓ The spiral point pushes the chips ahead.

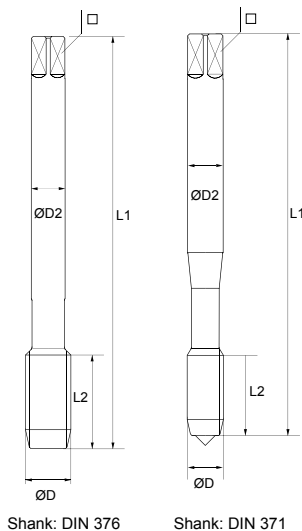

Machine Tap for high-alloyed steels and longer tool life time

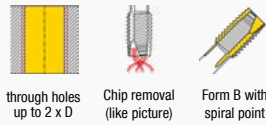
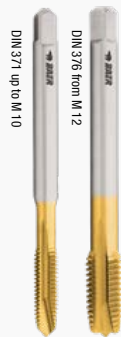
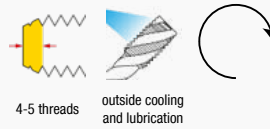
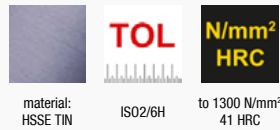
 through holes up to 2 x D
 Chip removal (like picture)
 Form B with spiral point

Machine Tap ECO for stainless steels with high tool life time

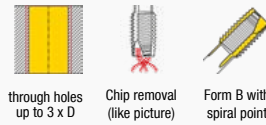
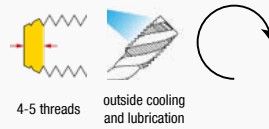
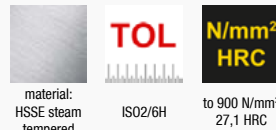

 through holes up to 3 x D
 Chip removal (like picture)
 Form B with spiral point

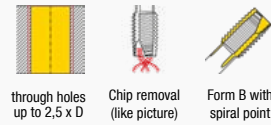
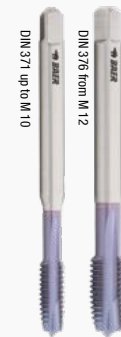
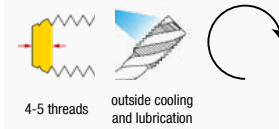
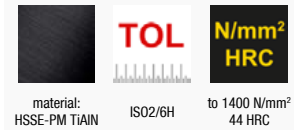
Machine Tap for high alloyed stainless steels and high-tensile materials

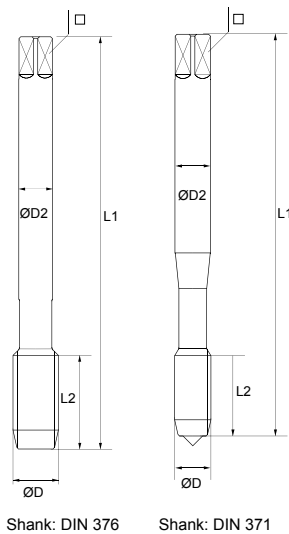

 through holes up to 2,5 x D
 Chip removal (like picture)
 Form B with spiral point

M	D1	D2	L1	L2	□	▣	No.	€	No.	€	No.	€
M 2 x 0,4	2,0	2,8	45	8	2,1	1,60	110404001	14,90	110405001	*	110406001	*
M 2,5 x 0,45	2,5	2,8	50	9	2,1	2,05	110404002	14,90	110405002	*	110406002	*
M 3 x 0,5	3,0	3,5	56	11	2,7	2,50	110404003	10,26	110405003	10,89	110406003	23,02
M 3,5 x 0,6	3,5	4,0	56	13	3,0	2,90	110404004	*				
M 4 x 0,7	4,0	4,5	63	13	3,4	3,30	110404005	10,26	110405004	10,89	110406004	23,02
M 5 x 0,8	5,0	6,0	70	16	4,9	4,20	110404006	10,68	110405005	11,84	110406005	24,30
M 6 x 1,0	6,0	6,0	80	19	4,9	5,00	110404007	11,21	110405006	11,84	110406006	26,86
M 7 x 1,0	7,0	7,0	80	19	5,5	6,00	110404008	18,46				
M 8 x 1,25	8,0	8,0	90	22	6,2	6,80	110404009	13,93	110405007	14,14	110406007	31,97
M 9 x 1,25	9,0	9,0	90	18	6,2	7,80	110404010	*				
M 10 x 1,5	10,0	10,0	100	24	8,0	8,50	110404011	17,81	110405008	19,90	110406008	39,59
M 12 x 1,75	12,0	9,0	110	29	7,0	10,20	110404012	23,67	110405009	25,24	110406009	54,74
M 14 x 2,0	14,0	11,0	110	30	9,0	12,00	110404013	28,38	110405010	28,59	110406010	80,53
M 16 x 2,0	16,0	12,0	110	32	9,0	14,00	110404014	31,63	110405011	30,79	110406011	94,21
M 18 x 2,5	18,0	14,0	125	34	11,0	15,50	110404015	46,92	110405012	46,50	110406012	*
M 20 x 2,5	20,0	16,0	140	34	12,0	17,50	110404016	56,98	110405013	65,36	110406013	*
M 22 x 2,5	22,0	18,0	140	34	14,5	19,50	110404017	*	110405014	93,22	110406014	*
M 24 x 3,0	24,0	18,0	160	38	14,5	21,00	110404018	*	110405015	101,27	110406015	*
M 27 x 3,0	27,0	20,0	160	38	16,0	24,00	110404019	*				
M 30 x 3,5	30,0	22,0	180	45	18,0	26,50	110404020	*				

- ☑ Tap for machine use in through hole.
- ☑ The spiral point pushes the chips ahead.

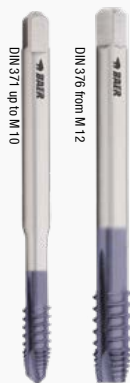
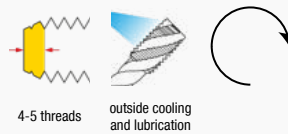
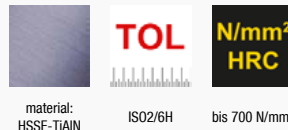
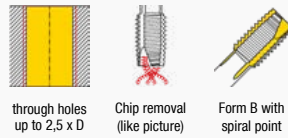

Machine Tap for aluminum



Machine Tap for special alloys (Inconel, Hastelloy etc.)

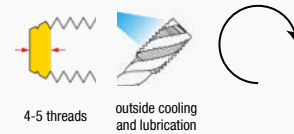
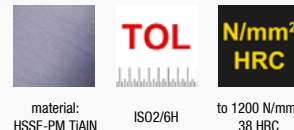
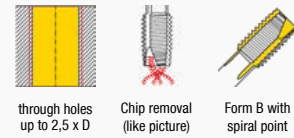

M	D1	D2	L1	L2	□		No.	€	No.	€
M 2 x 0,4	2,0	2,8	45	8	2,1	1,60			110412001	32,28
M 2,5 x 0,45	2,5	2,8	50	9	2,1	2,05			110412002	32,28
M 3 x 0,5	3,0	3,5	56	11	2,7	2,50	110407001	27,16	110412003	25,01
M 4 x 0,7	4,0	4,5	63	13	3,4	3,30	110407002	27,34	110412004	26,30
M 5 x 0,8	5,0	6,0	70	16	4,9	4,20	110407003	30,96	110412005	29,75
M 6 x 1,0	6,0	6,0	80	19	4,9	5,00	110407004	32,32	110412006	31,13
M 8 x 1,25	8,0	8,0	90	22	6,2	6,80	110407005	32,68	110412007	42,83
M 10 x 1,5	10,0	10,0	100	24	8,0	8,50	110407006	36,84	110412008	46,74
M 12 x 1,75	12,0	9,0	110	29	7,0	10,20	110407007	41,82	110412009	77,64
M 14 x 2,0	14,0	11,0	110	30	9,0	12,00	110407008	69,75	110412010	102,05
M 16 x 2,0	16,0	12,0	110	32	9,0	14,00	110407009	87,40	110412011	111,26
M 18 x 2,5	18,0	14,0	125	34	11,0	15,50			110412012	142,99
M 20 x 2,5	20,0	16,0	140	34	12,0	17,50			110412013	160,68
M 24 x 3,0	24,0	18,0	160	38	14,5	21,00			110412014	190,89
M 27 x 3,0	27,0	20,0	160	38	16,0	24,00			110412015	253,01
M 30 x 3,5	30,0	22,0	180	45	18,0	26,50			110412016	293,63

M

metric coarse thread / ISO DIN 13

- ☑ Tap for machine use in through hole.
- ☑ The spiral point pushes the chips ahead.

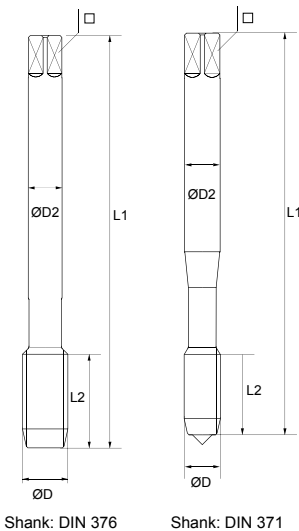

Machine Tap for general use **overlengthed (long shank)**

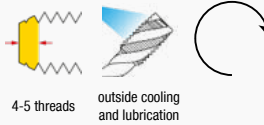
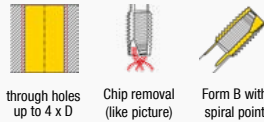

Machine Tap for general use **oversized (diameter)**

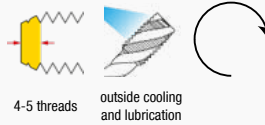
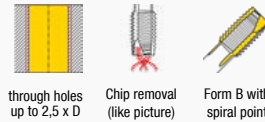

Machine Tap for general use **undersized (diameter)**

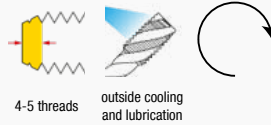
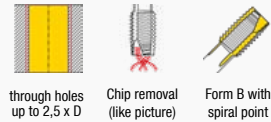

M	D1	D2	L1	L2	□	No.	€	Tol. 6G: threads with large clearance		Tol. 4H: threads with small clearance		
								No.	€	No.	€	
Total length L1 = 100 mm												
M 2 x 0,4	2,0	2,8	45	8	2,1	1,60				110420001	30,16	
M 2,5 x 0,45	2,5	2,8	50	9	2,1	2,05		110417001	8,90	110420002	29,34	
M 3 x 0,5	3,0	3,5	56	11	2,7	2,50	110414001	10,58	110417002	8,90	110420003	9,05
M 4 x 0,7	4,0	4,5	63	13	3,4	3,30	110414002	10,58	110417003	8,90	110420004	9,05
M 5 x 0,8	5,0	6,0	70	16	4,9	4,20	110414003	11,21	110417004	9,22	110420005	9,47
M 6 x 1,0	6,0	6,0	80	19	4,9	5,00	110414004	11,21	110417005	9,22	110420006	9,47
M 8 x 1,25	8,0	8,0	90	22	6,2	6,80	110414005	13,51	110417006	11,31	110420007	12,00
M 10 x 1,5	10,0	10,0	100	24	8,0	8,50	110414006	14,14	110417007	12,99	110420008	14,32
M 12 x 1,75	12,0	9,0	110	29	7,0	10,20	110414007	15,92	110417008	15,61	110420009	16,53
M 14 x 2,0	14,0	11,0	110	30	9,0	12,00			110417009	22,41	110420010	22,53
M 16 x 2,0	16,0	12,0	110	32	9,0	14,00			110417010	25,87	110420011	26,00
M 18 x 2,5	18,0	14,0	125	34	11,0	15,50			110417011	35,30		
M 20 x 2,5	20,0	16,0	140	34	12,0	17,50			110417012	49,44		
Total length L1 = 120 mm												
M 3 x 0,5	3,0	3,5	56	11	2,7	2,50			Tol. 7G: for disorted threads (heat treatment)			
M 4 x 0,7	4,0	4,5	63	13	3,4	3,30	110415001	11,21	110418001	9,01		
M 5 x 0,8	5,0	6,0	70	16	4,9	4,20	110415002	12,25	110418002	9,01		
M 6 x 1,0	6,0	6,0	80	19	4,9	5,00	110415003	12,25	110418003	9,43		
M 8 x 1,25	8,0	8,0	90	22	6,2	6,80	110415004	14,24	110418004	9,43		
M 10 x 1,5	10,0	10,0	100	24	8,0	8,50	110415005	16,13	110418005	11,94		
M 12 x 1,75	12,0	9,0	110	29	7,0	10,20	110415006	18,75	110418006	14,24		
									110418007	16,44		
Total length L1 = 150 mm												
M 3 x 0,5	3,0	3,5	56	11	2,7	2,50			Tol. 6H +0,1 mm: for electroplating allowance			
M 4 x 0,7	4,0	4,5	63	13	3,4	3,30	110416001	11,84	110419001	9,01		
M 5 x 0,8	5,0	6,0	70	16	4,9	4,20	110416002	13,09	110419002	9,01		
M 6 x 1,0	6,0	6,0	80	19	4,9	5,00	110416003	13,09	110419003	9,43		
M 8 x 1,25	8,0	8,0	90	22	6,2	6,80	110416004	16,02	110419004	9,43		
M 10 x 1,5	10,0	10,0	100	24	8,0	8,50	110416005	19,48	110419005	11,94		
M 12 x 1,75	12,0	9,0	110	29	7,0	10,20	110416006	22,94	110419006	14,24		
									110419007	16,44		

Machine Taps - Form C (straight flutes) for through holes and blind holes

M metric coarse thread / ISO DIN 13

- ✓ Tap for machine use in through hole and blind hole.
- ✓ The short lead-in chamfer makes that tap universal in application. The flutes can hold the most part of the chips.

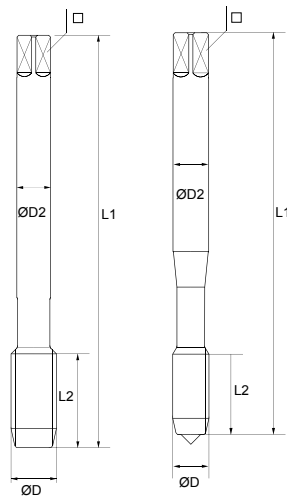

Shank: DIN 376 Shank: DIN 371

Machine Tap for general use

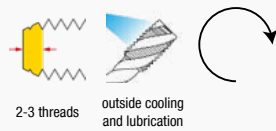
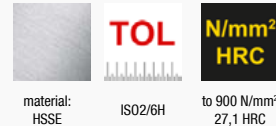
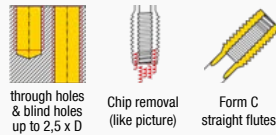

Machine Tap for general use Left-hand thread

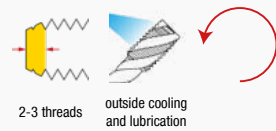
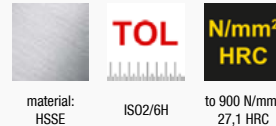
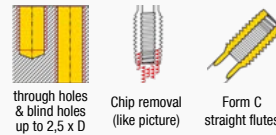

Machine Tap with longer tool life time

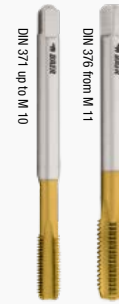
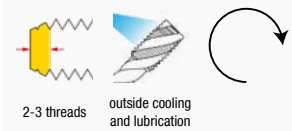
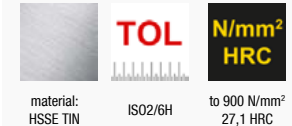
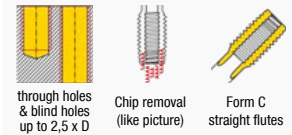

M	D1	D2	L1	L2	□	☒	No.	€	No.	€	No.	€
DIN 371												
M 2 x 0,4	2,0	2,8	45	8	2,1	1,60	110501001	8,80			110504001	25,10
M 2,2 x 0,45	2,2	2,8	45	8	2,1	1,75					110504002	29,09
M 2,3 x 0,4	2,3	2,8	45	9	2,1	1,90	110501002	8,80			110504003	31,97
M 2,5 x 0,45	2,5	2,8	50	9	2,1	2,05	110501003	8,80			110504004	23,10
M 2,6 x 0,45	2,6	2,8	50	9	2,1	2,10	110501004	8,80			110504005	22,26
M 3 x 0,5	3,0	3,5	56	11	2,7	2,50	110501005	6,28	110502001	12,25	110504006	15,34
M 3,5 x 0,6	3,5	4,0	56	13	3,0	2,90	110501006	7,02			110504007	19,16
M 4 x 0,7	4,0	4,5	63	13	3,4	3,30	110501007	6,28	110502002	12,25	110504008	15,35
M 5 x 0,8	5,0	6,0	70	16	4,9	4,20	110501008	6,70	110502003	12,78	110504009	17,78
M 6 x 1,0	6,0	6,0	80	19	4,9	5,00	110501009	6,70	110502004	12,78	110504010	17,96
M 7 x 1,0	7,0	7,0	80	19	5,5	6,00	110501010	9,32			110504011	19,94
M 8 x 1,25	8,0	8,0	90	22	6,2	6,80	110501011	8,38	110502005	15,29	110504012	23,81
M 9 x 1,25	9,0	9,0	90	18	6,2	7,80					110504013	36,11
M 10 x 1,5	10,0	10,0	100	24	8,0	8,50	110501012	10,47	110502006	17,39	110504014	36,80
DIN 376												
M 3 x 0,5	3,0	2,2	56	11	-	2,50	110501013	6,91				
M 4 x 0,7	4,0	2,8	63	13	2,1	3,30	110501014	6,91				
M 5 x 0,8	5,0	3,5	70	16	2,7	4,20	110501015	7,33				
M 6 x 1,0	6,0	4,5	80	19	3,4	5,00	110501016	7,33				
M 8 x 1,25	8,0	6,0	90	22	4,9	6,80	110501017	8,69				
M 10 x 1,5	10,0	7,0	100	24	5,5	8,50	110501018	11,00				
M 11 x 1,5	11,0	8,0	100	22	6,2	9,50					110504015	41,08
M 12 x 1,75	12,0	9,0	110	29	7,0	10,20	110501019	12,36	110502007	20,63	110504016	45,41
M 14 x 2,0	14,0	11,0	110	30	9,0	12,00	110501020	16,23	110502008	30,58	110504017	56,19
M 16 x 2,0	16,0	12,0	110	32	9,0	14,00	110501021	17,91	110502009	34,56	110504018	60,21
M 18 x 2,5	18,0	14,0	125	34	11,0	15,50	110501022	28,91	110502010	47,13	110504019	78,74
M 20 x 2,5	20,0	16,0	140	34	12,0	17,50	110501023	40,22	110502011	66,61	110504020	93,55
M 22 x 2,5	22,0	18,0	140	34	14,5	19,50	110501024	43,99	110502012	69,55	110504021	119,85
M 24 x 3,0	24,0	18,0	160	38	14,5	21,00	110501025	47,76	110502013	72,27	110504022	124,23
M 27 x 3,0	27,0	20,0	160	38	16,0	24,00	110501026	75,41			110504023	157,37
M 30 x 3,5	30,0	22,0	180	45	18,0	26,50	110501027	80,44			110504024	186,50
M 33 x 3,5	33,0	25,0	180	50	20,0	29,50	110501028	113,12			110504025	264,03
M 36 x 4,0	36,0	28,0	200	56	22,0	32,00	110501029	184,34			110504026	354,88
M 39 x 4,0	39,0	32,0	200	60	24,0	35,00	110501030	232,52				
M 42 x 4,5	42,0	32,0	200	60	24,0	37,50	110501031	273,36				
M 45 x 4,5	45,0	36,0	220	65	29,0	40,50	110501032	314,21				
M 48 x 5,0	48,0	36,0	250	70	29,0	43,00	110501033	339,35				
M 52 x 5,0	52,0	40,0	250	70	32,0	47,00	110501034	414,76				

Machine Taps - Form C (straight flutes) for through holes and blind holes

M metric coarse thread / ISO DIN 13

- ✓ Tap for machine use in through hole and blind hole.
- ✓ The short lead-in chamfer makes that tap universal in application. The flutes can hold the most part of the chips.

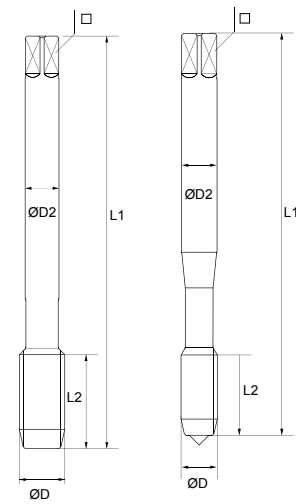

Shank: DIN 376

Shank: DIN 371

Machine Tap for cast materials

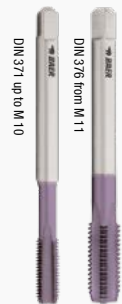
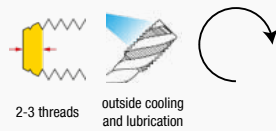
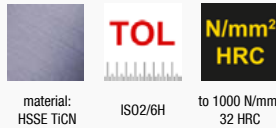
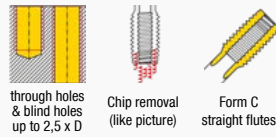

Machine Tap for titanium and titanium alloys

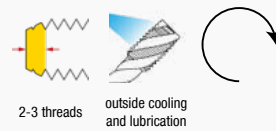
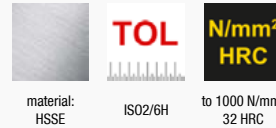
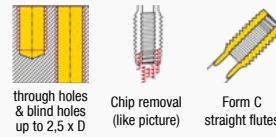

Machine Tap for brass (short-chipping)

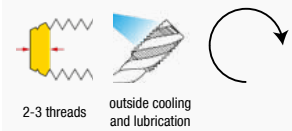
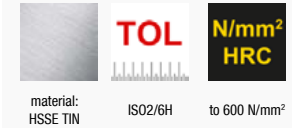
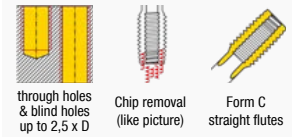

M	D1	D2	L1	L2	□	⚙️	No.	€	No.	€	No.	€
M 2 x 0,4	2,0	2,8	45	8	2,1	1,60			110511001	46,97		
M 2,5 x 0,45	2,5	2,8	50	9	2,1	2,05			110511002	46,97		
M 3 x 0,5	3,0	3,5	56	11	2,7	2,50	110510001	10,95	110511003	45,53	110509001	10,89
M 3,5 x 0,6	3,5	4,0	56	13	3,0	2,90	110510002	26,47				
M 4 x 0,7	4,0	4,5	63	13	3,4	3,30	110510003	10,95	110511004	48,41	110509002	10,89
M 5 x 0,8	5,0	6,0	70	16	4,9	4,20	110510004	11,89	110511005	49,13	110509003	11,84
M 6 x 1,0	6,0	6,0	80	19	4,9	5,00	110510005	11,89	110511006	49,67	110509004	11,84
M 7 x 1,0	7,0	7,0	80	19	5,5	6,00	110510006	35,44				
M 8 x 1,25	8,0	8,0	90	22	6,2	6,80	110510007	14,00	110511007	57,77	110509005	13,93
M 9 x 1,25	9,0	9,0	90	18	6,2	7,80	110510008	42,77				
M 10 x 1,5	10,0	10,0	100	24	8,0	8,50	110510009	19,16	110511008	69,10	110509006	19,06
M 11 x 1,5	11,0	8,0	100	22	6,2	9,50	110510010	52,75				
M 12 x 1,75	12,0	9,0	110	29	7,0	10,20	110510011	24,74	110511009	98,97	110509007	24,61
M 14 x 2,0	14,0	11,0	110	30	9,0	12,00	110510012	28,21	110511010	125,97	110509008	28,07
M 16 x 2,0	16,0	12,0	110	32	9,0	14,00	110510013	30,42	110511011	142,35	110509009	30,27
M 18 x 2,5	18,0	14,0	125	34	11,0	15,50	110510014	41,16	110511012	202,81		
M 20 x 2,5	20,0	16,0	140	34	12,0	17,50	110510015	57,47	110511013	224,58		
M 22 x 2,5	22,0	18,0	140	34	14,5	19,50	110510016	132,30				
M 24 x 3,0	24,0	18,0	160	38	14,5	21,00	110510017	158,95				
M 27 x 3,0	27,0	20,0	160	38	16,0	24,00	110510018	231,77				
M 30 x 3,5	30,0	22,0	180	45	18,0	26,50	110510019	300,20				
M 33 x 3,5	33,0	25,0	180	50	20,0	29,50	110510020	461,73				

Machine Taps - Form C (with spiral flutes) for blind holes

M metric coarse thread / ISO DIN 13

- ✓ Tap for machine use in blind holes.
- ✓ The fast spiral flutes provide good chip removal from the blind hole.

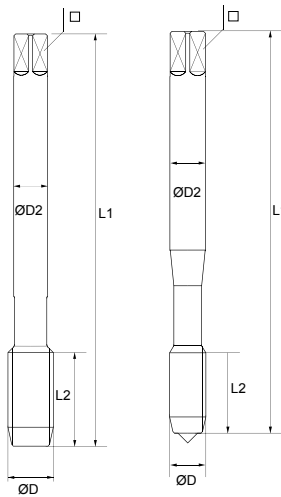

Shank: DIN 376

Shank: DIN 371

Machine Tap for universal use

UNI-TAP

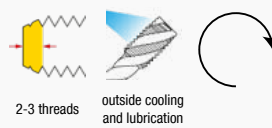
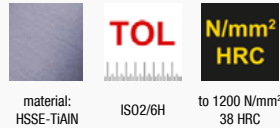
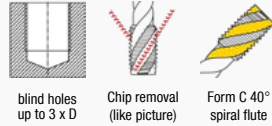

Machine Tap for general use

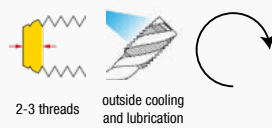
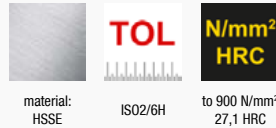
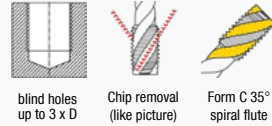

Machine Tap for general use Left-hand thread

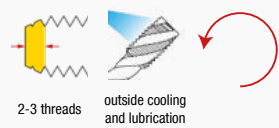
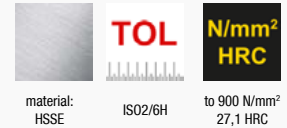
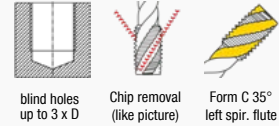

M	D1	D2	L1	L2	□	Image	No.	€	No.	€	No.	€
DIN 371												
M 2 x 0,4	2,0	2,8	45	6	2,1	1,60	110603001	15,52	110601001	9,43		
M 2,2 x 0,45	2,2	2,8	45	6	2,1	1,75	110603002	30,52				
M 2,5 x 0,45	2,5	2,8	50	6	2,1	2,05	110603003	15,24	110601002	9,43		
M 3 x 0,5	3,0	3,5	56	6	2,7	2,50	110603004	18,90	110601003	7,96	110602001	16,23
M 3,5 x 0,6	3,5	4,0	56	13	3,0	2,90	110603005	21,17	110601004	8,69		
M 4 x 0,7	4,0	4,5	63	7	3,4	3,30	110603006	18,52	110601005	7,96	110602002	16,23
M 5 x 0,8	5,0	6,0	70	8	4,9	4,20	110603007	18,74	110601006	8,80	110602003	17,39
M 6 x 1,0	6,0	6,0	80	10	4,9	5,00	110603008	19,56	110601007	8,80	110602004	17,39
M 7 x 1,0	7,0	7,0	80	19	5,5	6,00			110601008	12,15		
M 8 x 1,25	8,0	8,0	90	14	6,2	6,80	110603009	23,05	110601009	10,68	110602005	20,74
M 10 x 1,5	10,0	10,0	100	16	8,0	8,50	110603010	28,14	110601010	13,41	110602006	23,67
DIN 376												
M 3 x 0,5	3,0	2,2	56	6	-	2,50			110601011	8,69	110602007	16,23
M 4 x 0,7	4,0	2,8	63	7	2,1	3,30			110601012	8,69	110602008	16,23
M 5 x 0,8	5,0	3,5	70	8	2,7	4,20			110601013	9,22	110602009	17,39
M 6 x 1,0	6,0	4,5	80	10	3,4	5,00			110601014	9,22	110602010	17,39
M 8 x 1,25	8,0	6,0	90	14	4,9	6,80			110601015	11,21	110602011	20,74
M 10 x 1,5	10,0	7,0	100	16	5,5	8,50			110601016	13,41	110602012	23,67
M 12 x 1,75	12,0	9,0	110	18	7,0	10,20	110603011	35,28	110601017	15,71	110602013	26,92
M 14 x 2,0	14,0	11,0	110	20	9,0	12,00	110603012	45,15	110601018	20,21	110602014	34,35
M 16 x 2,0	16,0	12,0	110	22	9,0	14,00	110603013	56,83	110601019	22,41	110602015	39,59
M 18 x 2,5	18,0	14,0	125	25	11,0	15,50	110603014	77,27	110601020	33,31	110602016	52,79
M 20 x 2,5	20,0	16,0	140	25	12,0	17,50	110603015	82,32	110601021	43,99	110602017	75,41
M 22 x 2,5	22,0	18,0	140	27	14,5	19,50	110603016	87,90	110601022	57,81	110602018	84,52
M 24 x 3,0	24,0	18,0	160	30	14,5	21,00	110603017	94,21	110601023	60,33	110602019	87,14
M 27 x 3,0	27,0	20,0	160	30	16,0	24,00	110603018	113,79	110601024	98,03	110602020	149,77
M 30 x 3,5	30,0	22,0	180	35	18,0	26,50	110603019	242,08	110601025	103,06	110602021	155,01
M 33 x 3,5	33,0	25,0	180	35	20,0	29,50			110601026	147,05	110602022	215,76
M 36 x 4,0	36,0	28,0	200	40	22,0	32,00			110601027	232,52	110602023	362,39
M 39 x 4,0	39,0	32,0	200	40	24,0	35,00			110601028	295,36	110602024	445,13
M 42 x 4,5	42,0	32,0	200	45	24,0	37,50			110601029	351,92	110602025	519,49
M 45 x 4,5	45,0	36,0	220	45	29,0	40,50			110601030	395,91	110602026	589,67
M 48 x 5,0	48,0	36,0	250	50	29,0	43,00			110601031	433,61	110602027	644,13
M 52 x 5,0	52,0	40,0	250	50	32,0	47,00			110601032	515,31	110602028	752,01

Machine Taps - Form C (with spiral flutes) for blind holes

M

metric coarse thread / ISO DIN 13

✓ Tap for machine use in blind holes.

The fast spiral flutes

✓ provide good chip removal from the blind hole.

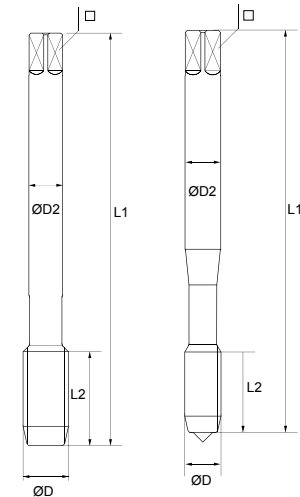

Shank: DIN 376

Shank: DIN 371

Machine Tap for high-alloyed steels and longer tool life time

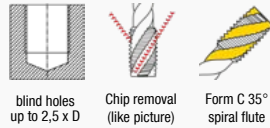

blind holes up to 2,5 x D
Chip removal (like picture)
Form C 35° spiral flute

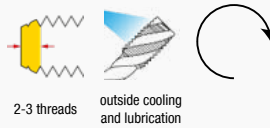

Machine Tap ECO for stainless steels with high tool life time

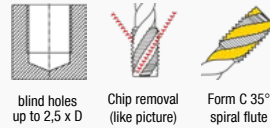

blind holes up to 2,5 x D
Chip removal (like picture)
Form C 35° spiral flute

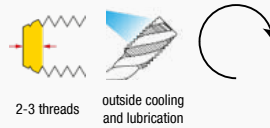

Machine Tap for high alloyed stainless steels and high-tensile materials

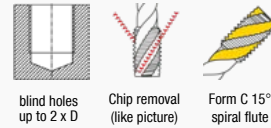

blind holes up to 2 x D
Chip removal (like picture)
Form C 15° spiral flute

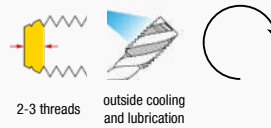

M	D1	D2	L1	L2	□	▣	No.	€	No.	€	No.	€
M 2 x 0,4	2,0	2,8	45	6	2,1	1,60	110604001	14,05			110606001	30,79
M 2,5 x 0,45	2,5	2,8	50	6	2,1	2,05	110604002	14,05			110606002	30,79
M 3 x 0,5	3,0	3,5	56	6	2,7	2,50	110604003	11,63	110605001	12,99	110606003	24,94
M 3,5 x 0,6	3,5	4,0	56	13	3,0	2,90	110604004	15,96				
M 4 x 0,7	4,0	4,5	63	7	3,4	3,30	110604005	11,63	110605002	12,99	110606004	24,94
M 5 x 0,8	5,0	6,0	70	8	4,9	4,20	110604006	12,36	110605003	14,24	110606005	26,86
M 6 x 1,0	6,0	6,0	80	10	4,9	5,00	110604007	12,88	110605004	14,24	110606006	30,05
M 7 x 1,0	7,0	7,0	80	19	5,5	6,00	110604008	13,71				
M 8 x 1,25	8,0	8,0	90	14	6,2	6,80	110604009	15,82	110605005	16,97	110606007	37,09
M 9 x 1,25	9,0	9,0	90	15	7,0	7,80	110604010	*				
M 10 x 1,5	10,0	10,0	100	16	8,0	8,50	110604011	20,00	110605006	23,98	110606008	46,68
M 11 x 1,5	11,0	8,0	100	18	6,2	9,50	110604012	*				
M 12 x 1,75	12,0	9,0	110	18	7,0	10,20	110604013	26,18	110605007	30,27	110606009	65,87
M 14 x 2,0	14,0	11,0	110	20	9,0	12,00	110604014	31,72	110605008	34,25	110606010	90,19
M 16 x 2,0	16,0	12,0	110	22	9,0	14,00	110604015	34,97	110605009	36,97	110606011	98,74
M 18 x 2,5	18,0	14,0	125	25	11,0	15,50	110604016	53,82	110605010	49,75	110606012	111,66
M 20 x 2,5	20,0	16,0	140	25	12,0	17,50	110604017	65,75	110605011	69,96	110606013	146,52
M 22 x 2,5	22,0	18,0	140	27	14,5	19,50	110604018	76,49	110605012	91,92	110606014	223,79
M 24 x 3,0	24,0	18,0	160	30	14,5	21,00	110604019	82,70	110605013	99,36	110606015	308,30
M 27 x 3,0	27,0	20,0	160	30	16,0	24,00	110604020	98,03				
M 30 x 3,5	30,0	22,0	180	35	18,0	26,50	110604021	103,06				

Machine Taps - Form C (with spiral flutes) for blind holes

M metric coarse thread / ISO DIN 13

- ✓ Tap for machine use in blind holes.
- ✓ The fast spiral flutes provide good chip removal from the blind hole.

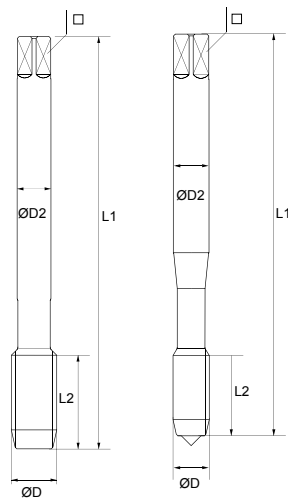

Shank: DIN 376

Shank: DIN 371

Machine Tap for aluminum (long-chipping)

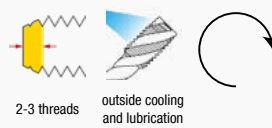
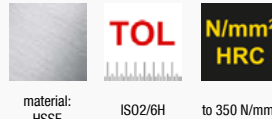
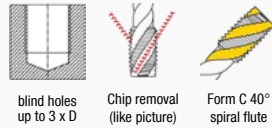

Machine Tap for long-chipping materials

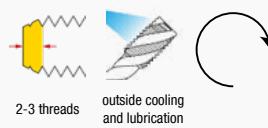
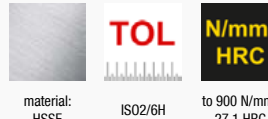
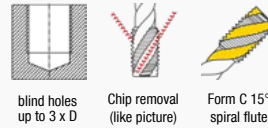

Machine Tap for special alloys (Inconel, Hastelloy etc.)

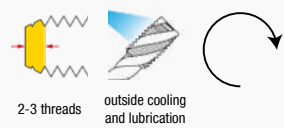
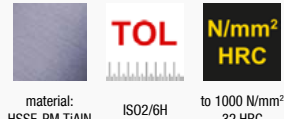
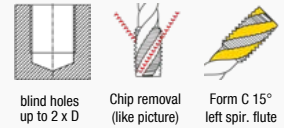

M	D1	D2	L1	L2	□	▣	No.	€	No.	€	No.	€
DIN 371												
M 3 x 0,5	3,0	3,5	56	6	2,7	2,50	110607001	11,94	110608001	9,89	110612001	28,56
M 3,5 x 0,6	3,5	4,0	56	13	3,0	2,90			110608002	10,21		
M 4 x 0,7	4,0	4,5	63	7	3,4	3,30	110607002	11,94	110608003	9,89	110612002	31,59
M 5 x 0,8	5,0	6,0	70	8	4,9	4,20	110607003	13,09	110608004	10,63	110612003	32,68
M 6 x 1,0	6,0	6,0	80	10	4,9	5,00	110607004	13,09	110608005	10,63	110612004	33,87
M 7 x 1,0	7,0	7,0	80	19	5,5	6,00			110608006	13,37		
M 8 x 1,25	8,0	8,0	90	14	6,2	6,80	110607005	15,08	110608007	13,05	110612005	40,69
M 10 x 1,5	10,0	10,0	100	16	8,0	8,50	110607006	22,41	110608008	15,05	110612006	54,00
DIN 376												
M 3 x 0,5	3,0	2,2	56	11	-	2,50			110608009	11,16		
M 4 x 0,7	4,0	2,8	63	13	2,1	3,30			110608010	11,16		
M 5 x 0,8	5,0	3,5	70	16	2,7	4,20			110608011	11,89		
M 6 x 1,0	6,0	4,5	80	19	3,4	5,00			110608012	11,89		
M 8 x 1,25	8,0	6,0	90	22	4,9	6,80			110608013	14,63		
M 10 x 1,5	10,0	7,0	100	24	5,5	8,50			110608014	16,95		
M 12 x 1,75	12,0	9,0	110	18	7,0	10,20	110607007	29,12	110608015	20,21	110612007	78,77
M 14 x 2,0	14,0	11,0	110	20	9,0	12,00	110607008	31,42	110608016	27,16	110612008	90,19
M 16 x 2,0	16,0	12,0	110	22	9,0	14,00	110607009	34,77	110608017	29,47	110612009	111,08
M 18 x 2,5	18,0	14,0	125	25	11,0	15,50			110608018	42,32	110612010	125,62
M 20 x 2,5	20,0	16,0	140	25	12,0	17,50			110608019	54,95	110612011	164,84
M 22 x 2,5	22,0	18,0	140	27	14,5	19,50			110608020	63,16		
M 24 x 3,0	24,0	18,0	160	30	14,5	21,00			110608021	66,95		

Machine Taps - Form C (with spiral flutes) for blind holes

M metric coarse thread / ISO DIN 13

- ✓ Tap for machine use in blind holes.
- ✓ The fast spiral flutes provide good chip removal from the blind hole.

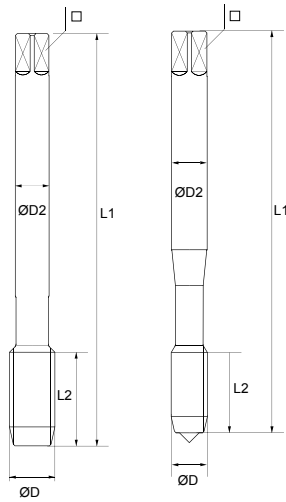

Shank: DIN 376

Shank: DIN 371

Machine Tap for general use overlengthed (long shank)

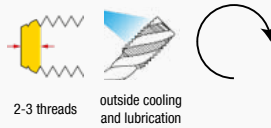
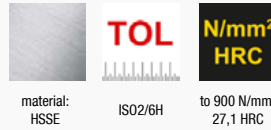
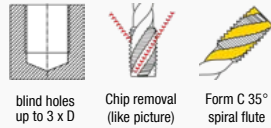

Machine Tap for general use oversized (diameter)

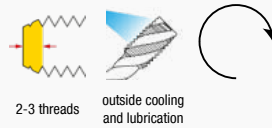
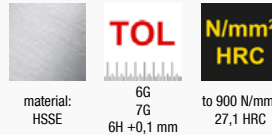
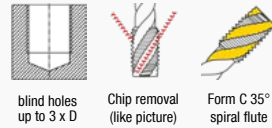

Machine Tap for general use undersized (diameter)

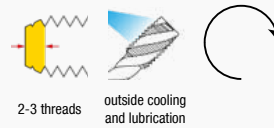
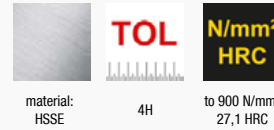
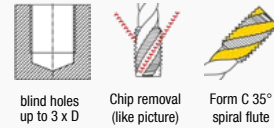

M	D1	D2	L1	L2			No.	€	No.	€	No.	€
Total length L1 = 100 mm												
M 2 x 0,4	2,0	2,8	45	6	2,1	1,60			Tol. 6G: threads with large clearance		Tol. 4H: threads with small clearance	
M 2,5 x 0,45	2,5	2,8	50	6	2,1	2,05					110620001	30,77
M 3 x 0,5	3,0	3,5	56	6	2,7	2,50	110614001	12,78	110617001	10,68	110620002	29,60
M 4 x 0,7	4,0	4,5	63	7	3,4	3,30	110614002	12,78	110617002	10,68	110620003	10,95
M 5 x 0,8	5,0	6,0	70	8	4,9	4,20	110614003	13,72	110617003	11,10	110620004	11,68
M 6 x 1,0	6,0	6,0	80	10	4,9	5,00	110614004	13,72	110617004	11,10	110620005	11,68
M 8 x 1,25	8,0	8,0	90	14	6,2	6,80	110614005	15,92	110617005	13,51	110620006	11,68
M 10 x 1,5	10,0	10,0	100	16	8,0	8,50	110614006	17,18	110617006	15,71	110620007	15,05
M 12 x 1,75	12,0	9,0	110	18	7,0	10,20	110614007	17,39	110617007	17,07	110620008	17,79
M 14 x 2,0	14,0	11,0	110	20	9,0	12,00			110617008	24,61	110620009	19,16
M 16 x 2,0	16,0	12,0	110	22	9,0	14,00			110617009	25,77		
M 18 x 2,5	18,0	14,0	125	25	11,0	15,50			110617010	38,65		
M 20 x 2,5	20,0	16,0	140	25	12,0	17,50			110617011	53,83		
Total length L1 = 120 mm												
M 3 x 0,5	3,0	3,5	56	6	2,7	2,50			Tol. 7G: for disorted threads (heat treatment)			
M 4 x 0,7	4,0	4,5	63	7	3,4	3,30	110615001	13,20	110618001	10,89		
M 5 x 0,8	5,0	6,0	70	8	4,9	4,20	110615002	14,66	110618002	10,89		
M 6 x 1,0	6,0	6,0	80	10	4,9	5,00	110615003	14,66	110618003	11,63		
M 8 x 1,25	8,0	8,0	90	14	6,2	6,80	110615004	16,76	110618004	11,63		
M 10 x 1,5	10,0	10,0	100	16	8,0	8,50	110615005	19,17	110618005	14,98		
M 12 x 1,75	12,0	9,0	110	18	7,0	10,20	110615006	20,32	110618006	17,70		
									110618007	19,06		
Total length L1 = 150 mm												
M 3 x 0,5	3,0	3,5	56	6	2,7	2,50			Tol. 6H +0,1 mm: for electroplating allowance			
M 4 x 0,7	4,0	4,5	63	7	3,4	3,30	110616001	13,72	110619001	10,89		
M 5 x 0,8	5,0	6,0	70	8	4,9	4,20	110616002	15,61	110619002	10,89		
M 6 x 1,0	6,0	6,0	80	10	4,9	5,00	110616003	15,61	110619003	11,63		
M 8 x 1,25	8,0	8,0	90	14	6,2	6,80	110616004	18,54	110619004	11,63		
M 10 x 1,5	10,0	10,0	100	16	8,0	8,50	110616005	22,41	110619005	14,98		
M 12 x 1,75	12,0	9,0	110	18	7,0	10,20	110616006	24,30	110619006	17,70		
									110619007	19,06		

M metric coarse thread / ISO DIN 13

Machine Nut Tap

Machine Tap for threading nuts up to 1,0 D. The flutes can hold the most part of the chips.

Combined Machine Tap

Machine Tap, which allows core hole drilling and thread tapping in one fluent process without changing tools.

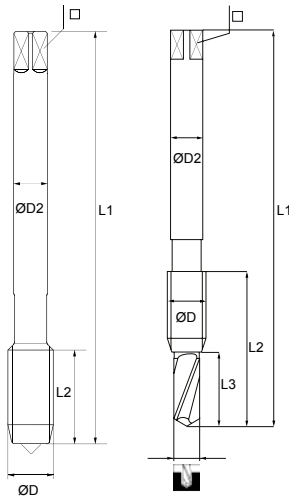

Shank: DIN 357

Machine Nut Tap for general use

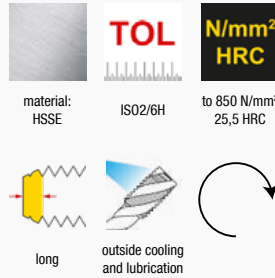
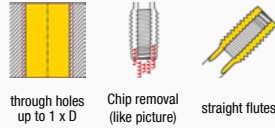

Combined Machine Tap for general use

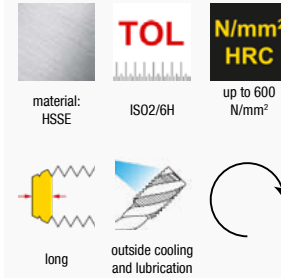
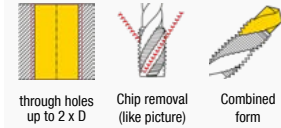

M	D1	D2	L1	L2	□	No.	€					□	No.	€	
								D2	L1	L2	L3				
M 3 x 0,5	3,0	2,2	70	22	-	2,50	110901001	17,18	3,0	56	22	11	2,4	111001001	20,32
M 4 x 0,7	4,0	2,8	90	25	2,1	3,30	110901002	17,18	4,0	63	28	14	3,0	111001002	20,32
M 5 x 0,8	5,0	3,5	100	28	2,7	4,20	110901003	18,43	5,0	71	36	18	3,8	111001003	20,32
M 6 x 1,0	6,0	4,5	110	32	3,4	5,00	110901004	18,43	6,0	80	44	22	4,9	111001004	22,62
M 8 x 1,25	8,0	6,0	125	40	4,9	6,80	110901005	21,16	8,0	95	50	25	6,2	111001005	25,87
M 10 x 1,5	10,0	7,0	140	45	5,5	8,50	110901006	27,65	10,0	106	62	31	8,0	111001006	28,38
M 12 x 1,75	12,0	9,0	180	50	7,0	10,20	110901007	38,96	12,0	115	70	35	9,0	111001007	33,31
M 14 x 2,0	14,0	11,0	200	56	9,0	12,00	110901008	48,81							
M 16 x 2,0	16,0	12,0	200	63	9,0	14,00	110901009	59,49							
M 18 x 2,5	18,0	14,0	220	63	11,0	15,50	110901010	67,24							
M 20 x 2,5	20,0	16,0	250	70	12,0	17,50	110901011	73,94							
M 22 x 2,5	22,0	18,0	280	80	14,5	19,50	110901012	88,50							
M 24 x 3,0	24,0	18,0	280	80	14,5	21,00	110901013	99,29							

M metric coarse thread / ISO DIN 13

Machine Forming Taps have following advantages:

- No chips
- Up to 20 times longer lifetime (compared to taps)
- Same forming tap for through and blind hole
- Wide range of materials can be processed
- Intersection of the thread is impossible
- Very high trueness
- Increased strength of the thread
- Higher surface quality
- Much higher cutting speed

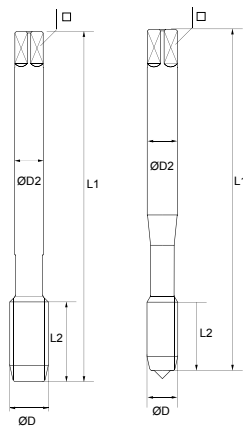

Shank: DIN 376 Shank: DIN 371

Machine Forming Taps for universal use

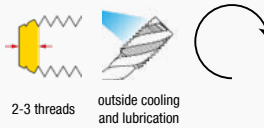
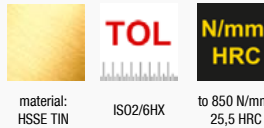
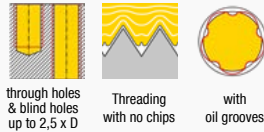

Machine Forming Taps for higher demands

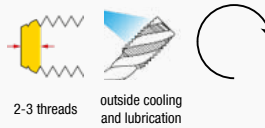
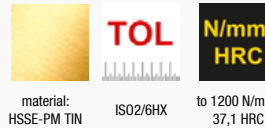
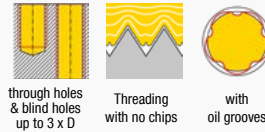

Machine Forming Taps for universal use oversized (diameter)

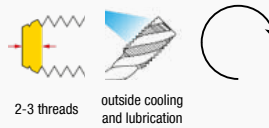
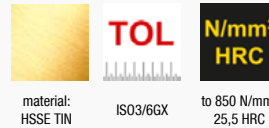
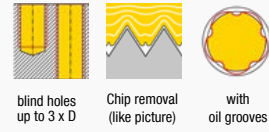

M	D1	D2	L1	L2	□	▣	Tol. 6HX: standard tolerance		Tol. 6GX: standard tolerance		Tol. 6GX: threads with large clearance	
							No.	€	No.	€	No.	€
M 2 x 0,4	2,0	2,8	45	8	2,1	1,85	111101001	38,95	111104001	64,79	111117001	52,36
M 2,2 x 0,45	2,2	2,8	45	8	2,1	2,03	111101002	54,53				
M 2,3 x 0,4	2,3	2,8	45	8	2,1	2,15	111101003	42,77				
M 2,5 x 0,45	2,5	2,8	50	9	2,1	2,33	111101004	38,95	111104002	61,73	111117002	50,21
M 2,6 x 0,45	2,6	2,8	50	9	2,1	2,43	111101005	40,89				
M 3 x 0,5	3,0	3,5	56	11	2,7	2,80	111101006	15,50	111104003	27,60	111117003	47,32
M 3,5 x 0,6	3,5	4,0	56	13	3,0	3,25	111101007	36,70	111104004	58,49	111117004	47,32
M 4 x 0,7	4,0	4,5	63	13	3,4	3,70	111101008	17,07	111104005	27,60	111117005	50,57
M 4,5 x 0,75	4,5	6,0	70	14	4,9	4,20	111101009	39,10				
M 5 x 0,8	5,0	6,0	70	16	4,9	4,65	111101010	18,43	111104006	27,60	111117006	50,57
M 6 x 1,0	6,0	6,0	80	19	4,9	5,10	111101011	18,96	111104007	33,65	111117007	50,57
M 8 x 1,25	8,0	8,0	90	22	6,2	7,45	111101012	23,04	111104008	39,04	111117008	62,99
M 10 x 1,5	10,0	10,0	100	24	8,0	9,35	111101013	27,65	111104009	47,66	111117009	76,66
M 12 x 1,75	12,0	9,0	110	29	7,0	11,25	111101014	37,18	111104010	59,83	111117010	100,05
M 14 x 2,0	14,0	11,0	110	30	9,0	13,10	111101015	56,35	111104011	81,30	111117011	138,02
M 16 x 2,0	16,0	12,0	110	32	9,0	15,10	111101016	66,40	111104012	212,89	111117012	175,46
M 18 x 2,5	18,0	14,0	125	34	11,0	16,85	111101017	172,26	111104013	300,16		
M 20 x 2,5	20,0	16,0	140	34	12,0	18,85	111101018	225,60	111104014	419,48		

M metric coarse thread / ISO DIN 13

Efficient internal thread cutting with batterypowered screwdriver (min. 7,5 Volt).

Application:

- ⚙ non abrasive material up to 900 N/mm unalloyed and low alloyed steel

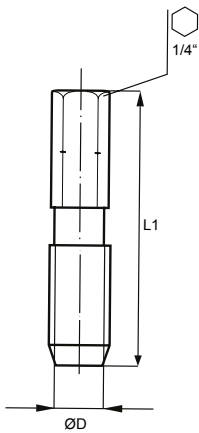

Bit-Taps Form D for through holes and blind holes

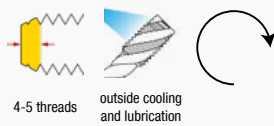
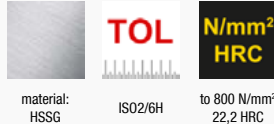
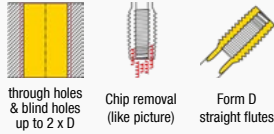

M	D1	L1	L2	Hex	ØD	No.	€
M 3 x 0,5	3,0	33	11	1/4"	2,50	111201001	3,79
M 3,5 x 0,6	3,5	34	10	1/4"	2,90	111201002	5,16
M 4 x 0,7	4,0	35	12	1/4"	3,30	111201003	3,79
M 4,5 x 0,75	4,5	35	12	1/4"	3,70	111201004	5,16
M 5 x 0,8	5,0	36	15	1/4"	4,20	111201005	4,84
M 5,5 x 0,9	5,5	35	15	1/4"	4,60	111201006	5,89
M 6 x 1,0	6,0	39	18	1/4"	5,00	111201007	4,84
M 7 x 1,0	7,0	38	16	1/4"	6,00	111201008	6,42
M 8 x 1,25	8,0	40	19	1/4"	6,80	111201009	6,84
M 9 x 1,25	9,0	41	18	1/4"	7,80	111201010	9,89
M 10 x 1,5	10,0	41	21	1/4"	8,50	111201011	8,11

M metric coarse thread / ISO DIN 13

Efficient internal thread cutting with batterypowered screwdriver (min. 7,5 Volt).

Core hole drilling and thread tapping in one fluent process.

Application:

- ⚙ non abrasive material up to 600 N/mm² unalloyed and low alloyed steel

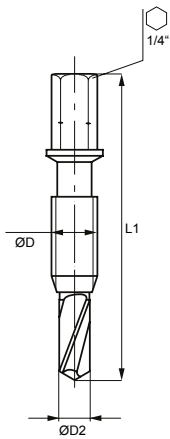

Kombi-Bit-Taps for through holes

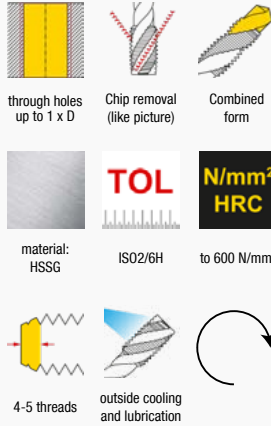

M	D1	D2	L1	Hex	No.	€
M 3 x 0,5	3,0	2,5	36	1/4"	111301001	7,16
M 4 x 0,7	4,0	3,3	39	1/4"	111301002	7,16
M 5 x 0,8	5,0	4,2	41	1/4"	111301003	7,16
M 6 x 1,0	6,0	5,0	44	1/4"	111301004	7,16
M 8 x 1,25	8,0	6,8	50	1/4"	111301005	9,89
M 10 x 1,5	10,0	8,5	59	1/4"	111301006	11,89

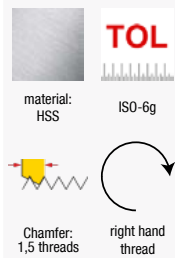
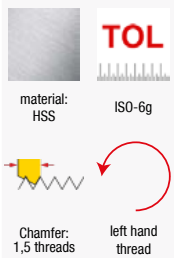
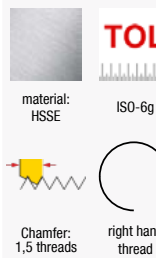
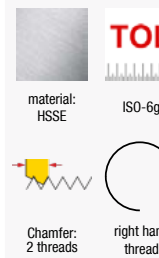
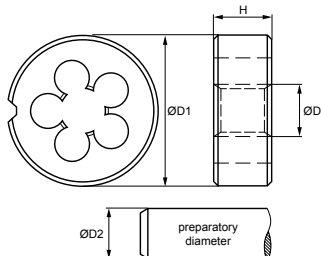
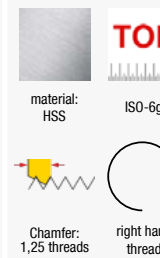
Round Dies for general use

Round Dies for general use Left Hand

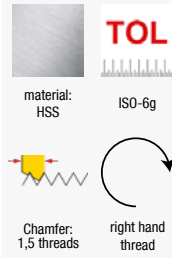
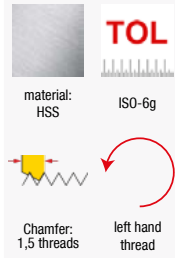
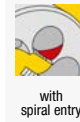
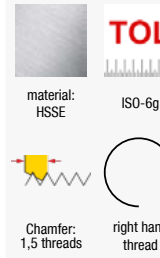
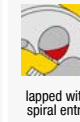
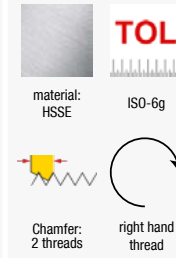
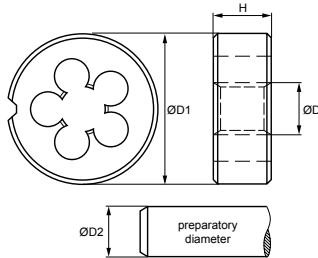
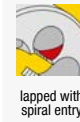
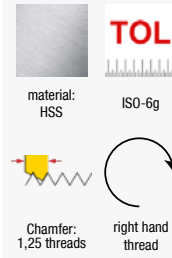
Round Dies for higher demands

Round Dies for stainless steels

Round Dies for brass

M

	D	D1	H	D2	No.	€	No.	€	No.	€	No.	€	No.	€
M 1 x 0,25	1,0	16	5	0,96	111401001	12,95								
M 1,1 x 0,25	1,1	16	5	1,05	111401002	12,95								
M 1,2 x 0,25	1,2	16	5	1,15	111401003	12,95								
M 1,4 x 0,3	1,4	16	5	1,36	111401004	12,95				111405001	99,19			
M 1,6 x 0,35	1,6	16	5	1,55	111401005	12,95				111405002	96,04			
M 1,7 x 0,35	1,7	16	5	1,64	111401006	12,95				111405003	96,04			
M 1,8 x 0,35	1,8	16	5	1,75	111401007	11,26								
M 2 x 0,4	2,0	16	5	1,95	111401008	11,26	111402001	20,94		111405004	78,08	111409001	75,24	
M 2,2 x 0,45	2,2	16	5	2,15	111401009	11,26								
M 2,3 x 0,4	2,3	16	5	2,23	111401010	11,26				111405005	78,08			
M 2,5 x 0,45	2,5	16	5	2,42	111401011	11,26				111405006	67,99	111409002	65,16	
M 2,6 x 0,45	2,6	16	5	2,53	111401012	11,26				111405007	70,82	111409003	65,16	
M 3 x 0,5	3,0	20	5	2,92	111401013	5,37	111402002	9,65	111404001	10,21	111405008	21,05	111409004	15,47
M 3,5 x 0,6	3,5	20	5	3,41	111401014	8,32					111405009	47,97	111409005	67,03
M 4 x 0,7	4,0	20	5	3,90	111401015	5,37	111402003	9,65	111404002	10,21	111405010	21,05	111409006	15,47
M 4,5 x 0,75	4,5	20	7	4,40	111401016	8,32								
M 5 x 0,8	5,0	20	7	4,90	111401017	5,68	111402004	10,36	111404003	10,63	111405011	21,05	111409007	15,47
M 5 x 0,9	5,0	20	7	4,89	111401018	11,79								
M 5,5 x 0,9	5,5	20	7	5,44	111401019	8,32								
M 6 x 1,0	6,0	20	7	5,88	111401020	5,68	111402005	10,36	111404004	10,63	111405012	21,05	111409008	15,47
M 7 x 1,0	7,0	25	9	6,88	111401021	9,05					111405013	69,63	111409009	58,51
M 8 x 1,25	8,0	25	9	7,86	111401022	6,00	111402006	11,99	111404005	15,05	111405014	24,95	111409010	16,63
M 9 x 1,25	9,0	25	9	8,86	111401023	10,21								
M 10 x 1,5	10,0	30	11	9,85	111401024	9,05	111402007	15,71	111404006	21,37	111405015	30,95	111409011	18,21
M 11 x 1,5	11,0	30	11	10,85	111401025	12,42								
M 12 x 1,75	12,0	38	14	11,83	111401026	14,63	111402008	22,34	111404007	33,68	111405016	38,11	111409012	25,47
M 14 x 2,0	14,0	38	14	13,82	111401027	14,63	111402009	25,60	111404008	33,68	111405017	38,11	111409013	27,68
M 15 x 2,0	15,0	38	14	14,91	111401028	22,63								
M 16 x 2,0	16,0	45	18	15,82	111401029	22,63	111402010	35,48	111404009	50,95	111405018	57,47		
M 18 x 2,5	18,0	45	18	17,79	111401030	22,63	111402011	35,48	111404010	50,95	111405019	57,47		
M 19 x 2,5	19,0	45	18	18,89	111401031	32,63								
M 20 x 2,5	20,0	45	18	19,79	111401032	22,63	111402012	35,48	111404011	50,95	111405020	57,47		
M 22 x 2,5	22,0	55	22	21,79	111401033	44,21	111402013	53,52	111404012	90,42	111405021	94,00		

Round Dies for general use

Round Dies for general use Left Hand

Round Dies for higher demands

Round Dies for stainless steels

Round Dies for brass

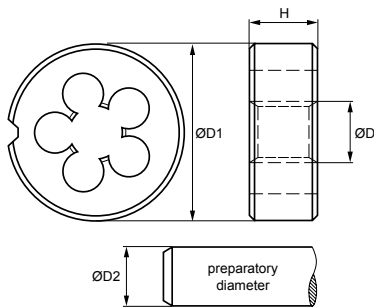
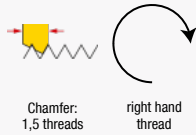
M

	D	D1	H	D2	No.	€	No.	€	No.	€	No.	€	No.	€
M 24 x 3,0	24,0	55	22	23,76	111401034	44,21	111402014	53,80	111404013	90,42	111405022	94,00		
M 27 x 3,0	27,0	65	25	26,76	111401035	59,16	111402015	97,06	111404014	133,89	111405023	148,11		
M 30 x 3,5	30,0	65	25	29,73	111401036	59,16	111402016	97,06	111404015	133,89	111405024	148,11		
M 33 x 3,5	33,0	65	25	32,73	111401037	63,16	111402017	97,06						
M 36 x 4,0	36,0	65	25	35,70	111401038	63,16	111402018	97,06						
M 39 x 4,0	39,0	75	30	38,70	111401039	103,16	111402019	163,73						
M 42 x 4,5	42,0	75	30	41,68	111401040	103,16	111402020	163,73						
M 45 x 4,5	45,0	90	36	44,68	111401041	175,79	111402021	257,26						
M 48 x 5,0	48,0	90	36	47,66	111401042	175,79	111402022	257,26						
M 52 x 5,0	52,0	90	36	51,66	111401043	175,79	111402023	257,26						
M 56 x 5,5	56,0	105	36	55,65	111401044	395,79								
M 60 x 5,5	60,0	105	36	59,65	111401045	395,79								
M 64 x 6,0	64,0	120	36	63,62	111401046	524,21								
M 68 x 6,0	68,0	120	36	67,62	111401047	524,21								
M 72 x 6,0	72,0	120	36		111401048	391,58								
M 76 x 6,0	76,0	120	36		111401049	391,58								
M 80 x 6,0	80,0	120	36		111401050	391,58								
M 84 x 6,0	84,0	130	36		111401051	498,95								
M 88 x 6,0	88,0	140	36		111401052	768,42								
M 90 x 6,0	90,0	140	36		111401053	768,42								
M 92 x 6,0	92,0	140	36		111401054	768,42								
M 96 x 6,0	96,0	140	36		111401055	768,42								
M 100 x 6,0	100,0	150	36		111401056	890,53								

Round Dies for general use undersized



material: HSS Ge



Round Dies for general use dimensions: 25 x 9



material: HSS ISO-6g

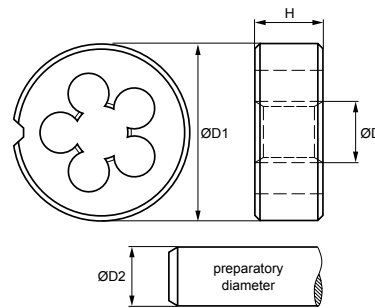
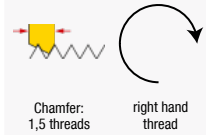

M	D	D1	H	D2	No.	€
M 3 x 0,5	3,0	20	5	2,89	111421001	9,31
M 4 x 0,7	4,0	20	5	3,87	111421002	9,31
M 5 x 0,8	5,0	20	7	4,86	111421003	9,66
M 6 x 1,0	6,0	20	7	5,85	111421004	9,66
M 8 x 1,25	8,0	25	9	7,83	111421005	10,36
M 10 x 1,5	10,0	30	11	9,81	111421006	13,39
M 12 x 1,75	12,0	38	14	11,81	111421007	20,71
M 14 x 2,0	14,0	38	14	13,87	111421008	26,76
M 16 x 2,0	16,0	45	18	15,87	111421009	40,26
M 18 x 2,5	18,0	45	18	17,75	111421010	40,26
M 20 x 2,5	20,0	45	18	19,75	111421011	40,26

M	D	D1	H	D2	No.	€
M 3 x 0,5	3,0	25	9	2,92	111422001	5,97
M 4 x 0,7	4,0	25	9	3,90	111422002	5,97
M 5 x 0,8	5,0	25	9	4,90	111422003	5,97
M 6 x 1,0	6,0	25	9	5,88	111422004	5,97
M 8 x 1,25	8,0	25	9	7,86	111422005	5,97
M 10 x 1,5	10,0	25	9	9,85	111422006	5,97
M 12 x 1,75	12,0	25	9	11,83	111422007	5,97

Hexagon Die Nuts for general use

Hexagon Die Nuts for general use Left Hand

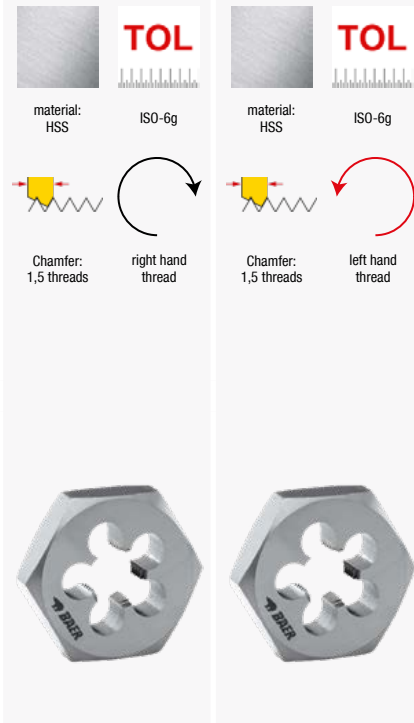

M	D	D1	H	D2	No.	€	No.	€
M 3 x 0,5	3,0	19	5	2,92	111501001	11,26	111502001	13,47
M 3,5 x 0,6	3,5	19	5	3,41	111501002	11,26		
M 4 x 0,7	4,0	19	5	3,90	111501003	11,26	111502002	13,47
M 5 x 0,8	4,5	19	7	4,40	111501004	11,26	111502003	14,63
M 6 x 1,0	6,0	19	7	5,88	111501005	11,26	111502004	14,63
M 7 x 1,0	7,0	22	9	6,88	111501006	12,42		
M 8 x 1,25	8,0	22	9	7,86	111501007	12,42	111502005	16,32
M 9 x 1,25	9,0	22	9	8,86	111501008	12,42		
M 10 x 1,5	10,0	27	11	9,85	111501009	14,63	111502006	23,05
M 11 x 1,5	11,0	27	11	10,85	111501010	14,63		
M 12 x 1,75	12,0	36	14	11,83	111501011	20,32	111502007	35,47
M 14 x 2,0	14,0	36	14	13,82	111501012	20,32	111502008	35,47
M 16 x 2,0	16,0	41	18	15,82	111501013	28,74	111502009	55,16
M 18 x 2,5	18,0	41	18	17,79	111501014	28,74	111502010	55,16
M 20 x 2,5	20,0	41	18	19,79	111501015	28,74	111502011	55,16
M 22 x 2,5	22,0	50	22	21,79	111501016	48,42	111502012	74,95
M 24 x 3,0	24,0	50	22	23,76	111501017	58,53	111502013	74,95
M 27 x 3,0	27,0	60	25	26,76	111501018	88,95	111502014	115,79
M 30 x 3,5	30,0	60	25	29,73	111501019	88,95	111502015	115,79
M 33 x 3,5	33,0	60	25	32,73	111501020	88,95	111502016	115,79
M 36 x 4,0	36,0	60	25	35,70	111501021	88,95	111502017	115,79
M 39 x 4,0	39,0	70	30	38,70	111501022	148,42	111502018	191,58
M 42 x 4,5	42,0	70	30	41,68	111501023	148,42	111502019	191,58
M 45 x 4,5	45,0	85	36	44,68	111501024	204,21	111502020	271,58
M 48 x 5,0	48,0	85	36	47,66	111501025	204,21	111502021	271,58
M 52 x 5,0	52,0	85	36	51,66	111501026	204,21	111502022	271,58
M 56 x 5,5	56,0	100	36	55,65	111501027	368,42		
M 60 x 5,5	60,0	100	36	59,65	111501028	368,42		
M 64 x 6,0	64,0	100	36	63,62	111501029	404,21		
M 68 x 6,0	68,0	115	36	67,62	111501030	524,21		

BAER Hand-Tap Sets, Round Dies and Tools Sets (example picture)



BAER Set MF 3 - MF 12 HSSG Hand Tap Sets & HSS Round Dies & Tools

299,55
€/Set

BAER HSSG Hand Tap Sets (2 parts)	MF 3 x 0,35 MF 4 x 0,5 MF 5 x 0,5 6 x 0,75 MF 8 x 0,75 MF 8 x 1,0 MF 10 x 1,0 MF 12 x 1,5
BAER HSS Round Dies	MF 3 x 0,35 MF 4 x 0,5 MF 5 x 0,5 6 x 0,75 MF 8 x 0,75 MF 8 x 1,0 MF 10 x 1,0 MF 12 x 1,5
BAER adjustable Tap Wrenches - zinc die cast	M 1-10 1/16-3/8 G 1/8 & M 4-12 5/32-1/2 G 1/8
BAER Die Stocks - zinc die cast	20 x 5 20 x 7 25 x 9 30 x 11 38 x 10
Screw extractor	

 Item No.:
264801002

BAER Set MF 6 - MF 20 HSSG Hand Tap Sets & HSS Round Dies & Tools

536,25
€/Set

BAER HSSG Hand Tap Sets (2 parts)	MF 6 x 0,75 MF 8 x 0,75 MF 8 x 1,0 MF 10 x 1,0 MF 12 x 1,0 MF 12 x 1,5 MF 14 x 1,25 MF 14 x 1,5 MF 16 x 1,5 MF 18 x 1,5 MF 20 x 1,5
BAER HSS Round Dies	MF 6 x 0,75 MF 8 x 0,75 MF 8 x 1,0 MF 10 x 1,0 MF 12 x 1,0 MF 12 x 1,5 MF 14 x 1,25 MF 14 x 1,5 MF 16 x 1,5 MF 18 x 1,5 MF 20 x 1,5
BAER adjustable Tap Wrenches - zinc die cast	M 1-10 1/16-3/8 G 1/8 & M 5-20 7/32-3/4 G 1/8-G 1/2
BAER Die Stocks - zinc die cast	20 x 7 25 x 9 30 x 11 38 x 10 45 x 14
Screw extractor	

 Item No.:
264801102

BAER Set MF 6 - MF 24 HSSG Hand Tap Sets & HSS Round Dies & Tools

783,43
€/Set

BAER HSSG Hand Tap Sets (2 parts)	MF 6 x 0,75 MF 8 x 0,75 MF 8 x 1,0 MF 10 x 1,0 MF 12 x 1,0 MF 12 x 1,5 MF 14 x 1,25 MF 14 x 1,5 MF 16 x 1,5 MF 18 x 1,5 MF 20 x 1,5 MF 22 x 1,5 MF 24 x 1,5
BAER HSS Round Dies	MF 6 x 0,75 MF 8 x 0,75 MF 8 x 1,0 MF 10 x 1,0 MF 12 x 1,0 MF 12 x 1,5 MF 14 x 1,25 MF 14 x 1,5 MF 16 x 1,5 MF 18 x 1,5 MF 20 x 1,5 MF 22 x 1,5 MF 24 x 1,5
BAER adjustable Tap Wrenches - zinc die cast	M 1-10 1/16-3/8 G 1/8 & M 11-27 7/16-1" G 1/4-G 3/4
BAER Die Stocks - zinc die cast	20 x 7 25 x 9 30 x 11 38 x 10 45 x 14 55 x 16
Screw extractor	

 Item No.:
264801202

BAER Short Machine Taps und Round Dies Sets MF 5 - MF 12 (example picture)



BAER Set MF 5 - MF 12 HSSG Short Machine Taps & Drill bits for core holes HSS Round Dies

BAER HSSG Short Machine Tap M 5 x 0,5 | M 6 x 0,75 | M 8 x 1,0 | M 10 x 1,0 | M 12 x 1,5
Form D for through hole & blind hole
(up to 4 x D)

BAER HSSG Drill bits for core holes 4,3 mm | 5,2 mm | 7,0 mm | 9,0 mm | 10,5 mm

BAER HSS Round Dies M 5 x 0,5 | M 6 x 0,75 | M 8 x 1,0 | M 10 x 1,0 | M 12 x 1,5

159,15
€/Set

Item No.:
BES1

MF Metric fine thread / ISO DIN 13

Efficient internal thread cutting.

The short structural type makes that tap usable by machine and hand.

Application:

- ⚙ non abrasive material up to 900 N/mm²
- ⚙ unalloyed and low alloyed steel

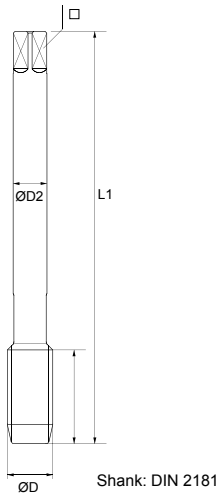

Short Machine Taps
Form D for through holes and blind holes

through holes & blind holes up to 4 x D

Chip removal (like picture)

Form D straight flutes

material: HSSG ISO2/6H to 900 N/mm² 27,1 HRC

4-5 threads

outside cooling and lubrication

MF	D1	D2	L1	L2	□	⚙	No.	€
MF 6 x 0,75	6,0	6,0	50	14	4,9	5,20	120101001	6,97
MF 8 x 0,75	8,0	6,0	50	19	4,9	6,20	120101002	6,97
MF 8 x 1,0	8,0	6,0	56	22	4,9	7,00	120101003	6,97
MF 9 x 0,75	9,0	7,0	56	19	5,5	8,20	120101004	7,80
MF 9 x 1,0	9,0	7,0	63	20	5,5	8,00	120101005	7,80
MF 10 x 0,75	10,0	7,0	63	20	5,5	9,20	120101006	7,80
MF 10 x 1,0	10,0	7,0	63	20	5,5	9,00	120101007	6,97
MF 10 x 1,25	10,0	7,0	70	24	5,5	8,80	120101008	7,80
MF 12 x 1,0	12,0	9,0	70	22	7,0	11,00	120101009	10,12
MF 12 x 1,25	12,0	9,0	70	22	7,0	10,80	120101010	10,12
MF 12 x 1,5	12,0	9,0	70	22	7,0	10,50	120101011	9,19
MF 13 x 1,0	13,0	11,0	70	22	9,0	12,00	120101012	15,48
MF 13 x 1,5	13,0	11,0	70	22	9,0	11,50	120101013	15,48
MF 14 x 1,0	14,0	11,0	70	22	9,0	13,00	120101014	15,48
MF 14 x 1,25	14,0	11,0	70	22	9,0	12,80	120101015	11,63
MF 14 x 1,5	14,0	11,0	70	22	9,0	12,50	120101016	10,01
MF 15 x 1,5	15,0	12,0	70	22	9,0	13,50	120101017	17,10
MF 16 x 1,5	16,0	12,0	70	22	9,0	14,50	120101018	12,22
MF 18 x 1,0	18,0	14,0	80	22	11,0	17,00	120101019	18,73
MF 18 x 1,5	18,0	14,0	80	22	11,0	16,50	120101020	14,08
MF 20 x 1,5	20,0	16,0	80	22	12,0	18,50	120101021	17,10
MF 20 x 2,0	20,0	16,0	80	22	12,0	18,00	120101022	23,51
MF 22 x 1,5	22,0	18,0	80	22	14,5	20,50	120101023	24,32
MF 22 x 2,0	22,0	18,0	80	22	14,5	20,00	120101024	24,32
MF 24 x 1,5	24,0	18,0	90	22	14,5	22,50	120101025	25,60
MF 24 x 2,0	24,0	18,0	90	22	14,5	22,00	120101026	32,58
MF 25 x 1,5	25,0	18,0	90	22	14,5	23,50	120101027	47,70
MF 26 x 1,5	26,0	18,0	90	22	14,5	24,50	120101028	47,70
MF 27 x 1,5	27,0	20,0	90	22	16,0	25,50	120101029	47,70
MF 28 x 1,5	28,0	20,0	90	22	16,0	26,50	120101030	56,43
MF 30 x 1,5	30,0	22,0	90	22	18,0	28,50	120101031	66,32
MF 30 x 2,0	30,0	22,0	90	22	18,0	28,00	120101032	66,32
MF 32 x 1,5	32,0	22,0	90	22	18,0	30,50	120101033	66,32

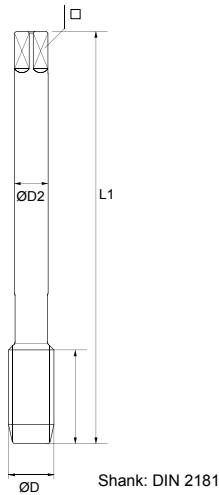

Hand Tap Sets for general use

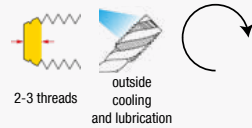
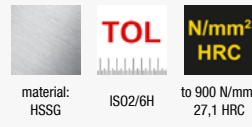
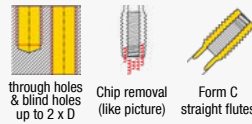

Hand Tap Sets for general use Left Hand

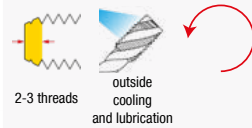
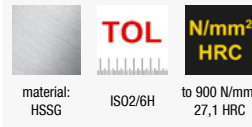
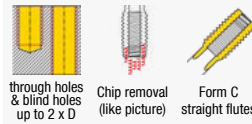

Hand Tap Sets HSSE for higher demands

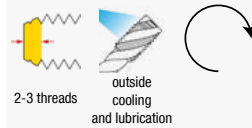
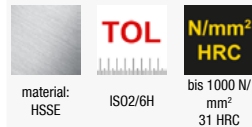
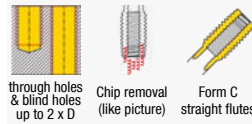
MF

	D1	D2	L1	L2	□		No.	€	No.	€	No.	€
MF 2,5 x 0,35	2,5	2,8	40	9	2,1	2,15	120301001	15,59				
MF 2,6 x 0,35	2,6	2,8	40	9	2,1	2,25	120301002	15,59				
MF 3 x 0,35	3,0	3,5	40	9	2,7	2,65	120301003	15,59				
MF 3,5 x 0,35	3,5	4,0	45	10	3,0	3,15	120301004	15,59				
MF 4 x 0,35	4,0	4,5	45	10	3,4	3,65	120301005	15,59				
MF 4 x 0,5	4,0	4,5	45	10	3,4	3,50	120301006	15,59				
MF 4,5 x 0,5	4,5	6,0	50	12	4,9	4,00	120301007	15,59				
MF 5 x 0,5	5,0	6,0	50	12	4,9	4,50	120301008	15,59				
MF 5 x 0,75	5,0	6,0	50	12	4,9	4,25	120301009	15,59				
MF 5,5 x 0,5	5,5	6,0	50	12	4,9	5,00	120301010	15,59				
MF 6 x 0,5	6,0	6,0	50	14	4,9	5,50	120301011	15,59				
MF 6 x 0,75	6,0	6,0	50	14	4,9	5,20	120301012	13,97	120302001	20,82	120304001	18,71
MF 7 x 0,5	7,0	6,0	50	14	4,9	6,50	120301013	13,97				
MF 7 x 0,75	7,0	6,0	50	14	4,9	6,20	120301014	13,97				
MF 8 x 0,5	8,0	6,0	50	19	4,9	7,50	120301015	13,97				
MF 8 x 0,75	8,0	6,0	50	19	4,9	7,20	120301016	13,97	120302002	20,82	120304002	18,71
MF 8 x 1	8,0	6,0	56	22	4,9	7,00	120301017	13,97	120302003	20,82	120304003	18,71
MF 9 x 0,5	9,0	7,0	56	19	5,5	8,50	120301018	15,59				
MF 9 x 0,75	9,0	7,0	56	19	5,5	8,25	120301019	15,59				
MF 9 x 1	9,0	7,0	63	20	5,5	8,00	120301020	15,59				
MF 10 x 0,5	10,0	7,0	63	20	5,5	9,50	120301021	15,59				
MF 10 x 0,75	10,0	7,0	63	20	5,5	9,20	120301022	15,59				
MF 10 x 1,0	10,0	7,0	63	20	5,5	9,00	120301023	13,97	120302004	20,82	120304004	20,35
MF 10 x 1,25	10,0	7,0	70	24	5,5	8,80	120301024	15,59	120302005	23,38	120304005	23,38
MF 11 x 0,75	11,0	8,0	63	20	6,2	10,20	120301025	20,24				
MF 11 x 1,0	11,0	8,0	63	20	6,2	10,00	120301026	20,24				
MF 11 x 1,25	11,0	8,0	63	22	6,2	10,80	120301027	20,24				
MF 12 x 0,5	12,0	9,0	70	22	7,0	11,50	120301028	20,24				
MF 12 x 0,75	12,0	9,0	70	22	7,0	10,20	120301029	20,24				
MF 12 x 1,0	12,0	9,0	70	22	7,0	11,00	120301030	20,24	120302006	30,88	120304006	28,30
MF 12 x 1,25	12,0	9,0	70	22	7,0	10,80	120301031	20,24	120302007	30,88	120304007	28,30
MF 12 x 1,5	12,0	9,0	70	22	7,0	10,50	120301032	18,39	120302008	28,30	120304008	28,30
MF 13 x 0,5	13,0	11,0	70	22	9,0	12,50	120301033	30,95				

MF Metric fine thread / ISO DIN 13

Efficient internal thread cutting.

The short structural type makes that tap usable by machine and hand.

A Hand-Tap-Set includes 2 taps:

Taper Tap

Finish Tap

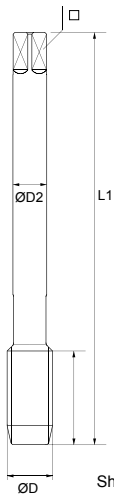

Hand Tap Sets for general use

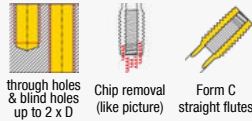

material: HSSG
ISO2/6H
TOL
N/mm² HRC
to 900 N/mm²
27,1 HRC

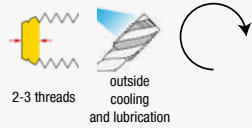

Hand Tap Sets for general use Left Hand

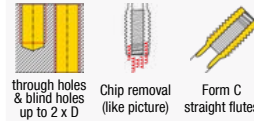

material: HSSG
ISO2/6H
TOL
N/mm² HRC
to 900 N/mm²
27,1 HRC

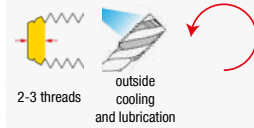

Hand Tap Sets HSSE for higher demands

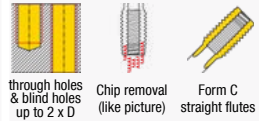

material: HSSE
ISO2/6H
TOL
N/mm² HRC
bis 1000 N/mm²
31 HRC

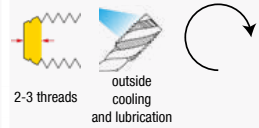

MF	D1	D2	L1	L2	□		No.	€	No.	€	No.	€
MF 13 x 0,75	13,0	11,0	70	22	9,0	12,20	120301034	31,10				
MF 13 x 1,0	13,0	11,0	70	22	9,0	12,00	120301035	31,10				
MF 13 x 1,5	13,0	11,0	70	22	9,0	11,50	120301036	31,10				
MF 14 x 0,5	14,0	11,0	70	22	9,0	13,50	120301037	31,10				
MF 14 x 0,75	14,0	11,0	70	22	9,0	13,20	120301038	31,10				
MF 14 x 1,0	14,0	11,0	70	22	9,0	13,00	120301039	31,10				
MF 14 x 1,25	14,0	11,0	70	22	9,0	12,80	120301040	23,38	120302009	34,39	120304009	32,74
MF 14 x 1,5	14,0	11,0	70	22	9,0	12,50	120301041	20,12	120302010	30,88	120304010	29,70
MF 15 x 0,75	15,0	12,0	70	22	9,0	14,20	120301042	34,38				
MF 15 x 1,0	15,0	12,0	70	22	9,0	14,00	120301043	34,38				
MF 15 x 1,5	15,0	12,0	70	22	9,0	13,50	120301044	34,38				
MF 16 x 0,5	16,0	12,0	70	22	9,0	15,50	120301045	34,38				
MF 16 x 0,75	16,0	12,0	70	22	9,0	15,20	120301046	34,38				
MF 16 x 1,0	16,0	12,0	70	22	9,0	15,00	120301047	34,38	120302011	51,46	120304011	37,65
MF 16 x 1,25	16,0	12,0	70	22	9,0	14,80	120301048	34,38				
MF 16 x 1,5	16,0	12,0	70	22	9,0	14,50	120301049	24,56	120302012	36,95	120304012	43,27
MF 17 x 1	17,0	12,0	70	22	9,0	16,00	120301050	37,65				
MF 17 x 1,5	17,0	12,0	70	22	9,0	15,50	120301051	37,65				
MF 18 x 0,5	18,0	14,0	80	22	11,0	17,50	120301052	37,65				
MF 18 x 0,75	18,0	14,0	80	22	11,0	17,20	120301053	37,65				
MF 18 x 1,0	18,0	14,0	80	22	11,0	17,00	120301054	37,65				
MF 18 x 1,25	18,0	14,0	80	22	11,0	16,80	120301055	37,65				
MF 18 x 1,5	18,0	14,0	80	22	11,0	16,50	120301056	28,30	120302013	43,27	120304013	52,40
MF 18 x 2,0	18,0	14,0	80	22	11,0	16,00	120301057	37,65				
MF 19 x 1	19,0	16,0	80	22	12,0	18,00	120301058	47,24				
MF 19 x 1,5	19,0	14,0	80	22	11,0	17,50	120301059	47,24				
MF 20 x 0,5	20,0	16,0	80	22	12,0	19,50	120301060	47,24				
MF 20 x 0,75	20,0	16,0	80	22	12,0	19,20	120301061	47,24				
MF 20 x 1,0	20,0	16,0	80	22	12,0	19,00	120301062	47,24				
MF 20 x 1,25	20,0	16,0	80	22	12,0	18,80	120301063	47,24				
MF 20 x 1,5	20,0	16,0	80	22	12,0	18,50	120301064	34,38	120302014	51,46	120304014	49,12
MF 20 x 2,0	20,0	16,0	80	22	12,0	18,00	120301065	47,24			120304015	65,49
MF 21 x 1	21,0	16,0	80	22	12,0	20,00	120301066	48,88				

MF Metric fine thread / ISO DIN 13

Efficient internal thread cutting.

The short structural type makes that tap usable by machine and hand.

A Hand-Tap-Set includes 2 taps:

- Taper Tap
- Finish Tap

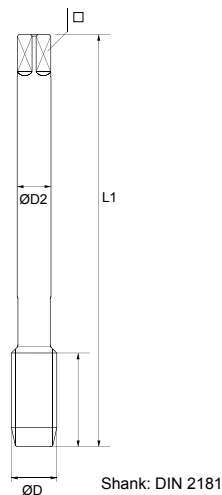

Hand Tap Sets for general use

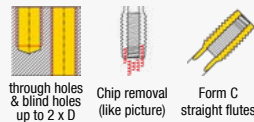

material: HSSG
TOL ISO2/6H
N/mm² HRC to 900 N/mm² 27,1 HRC

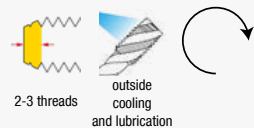

Hand Tap Sets for general use Left Hand

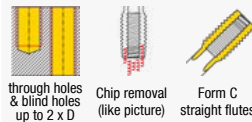

material: HSSG
TOL ISO2/6H
N/mm² HRC to 900 N/mm² 27,1 HRC

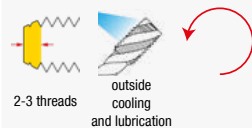

Hand Tap Sets HSSE for higher demands

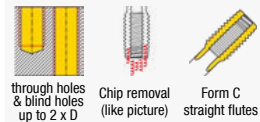

material: HSSE
TOL ISO2/6H
N/mm² HRC bis 1000 N/mm² 31 HRC

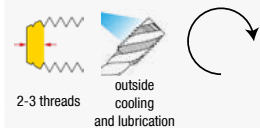

MF	D1	D2	L1	L2	□		No.	€	No.	€	No.	€
MF 21 x 1,5	21,0	16,0	80	22	12,0	19,50	120301067	48,88				
MF 22 x 0,5	22,0	18,0	80	22	14,5	21,50	120301068	48,88				
MF 22 x 0,75	22,0	18,0	80	22	14,5	21,20	120301069	48,88				
MF 22 x 1,0	22,0	18,0	80	22	14,5	21,00	120301070	48,88				
MF 22 x 1,25	22,0	18,0	80	22	14,5	20,80	120301071	48,88				
MF 22 x 1,5	22,0	18,0	80	22	14,5	20,50	120301072	48,88	120302015	67,83	120304016	61,28
MF 22 x 2,0	22,0	18,0	80	22	14,5	20,00	120301073	48,88			120304017	65,49
MF 23 x 1	23,0	18,0	80	22	14,5	22,00	120301074	65,49				
MF 23 x 1,5	23,0	18,0	80	22	14,5	21,50	120301075	65,49				
MF 24 x 0,5	24,0	18,0	90	22	14,5	23,50	120301076	65,49				
MF 24 x 0,75	24,0	18,0	90	22	14,5	23,20	120301077	65,49				
MF 24 x 1,0	24,0	18,0	90	22	14,5	23,00	120301078	65,49				
MF 24 x 1,25	24,0	18,0	90	22	14,5	23,80	120301079	65,49				
MF 24 x 1,5	24,0	18,0	90	22	14,5	22,50	120301080	51,45	120302016	74,84	120304018	81,86
MF 24 x 2,0	24,0	18,0	90	22	14,5	22,00	120301081	65,49	120302017	98,24		
MF 25 x 1,0	25,0	18,0	90	22	14,5	24,00	120301082	95,90				
MF 25 x 1,5	25,0	18,0	90	22	14,5	23,50	120301083	95,90				
MF 26 x 1,0	26,0	18,0	90	22	14,5	25,00	120301084	95,90				
MF 26 x 1,5	26,0	18,0	90	22	14,5	24,50	120301085	95,90				
MF 26 x 2,0	26,0	18,0	90	22	14,5	24,00	120301086	95,90				
MF 27 x 1	27,0	20,0	90	22	16,0	26,00	120301087	95,90				
MF 27 x 1,5	27,0	20,0	90	22	16,0	25,50	120301088	95,90				
MF 27 x 2,0	27,0	20,0	90	22	16,0	25,00	120301089	113,43				
MF 28 x 1,0	28,0	20,0	90	22	16,0	27,00	120301090	113,43				
MF 28 x 1,5	28,0	20,0	90	22	16,0	26,50	120301091	113,43				
MF 28 x 2,0	28,0	20,0	90	22	16,0	26,00	120301092	113,43				
MF 29 x 1,5	29,0	22,0	90	22	18,0	27,50	120301093	113,43				
MF 30 x 1,0	30,0	22,0	90	22	18,0	29,00	120301094	133,32				
MF 30 x 1,5	30,0	22,0	90	22	18,0	28,50	120301095	133,32	120302018	198,81		
MF 30 x 2,0	30,0	22,0	90	22	18,0	28,00	120301096	133,32	120302019	198,81		
MF 30 x 2,5	30,0	22,0	125	56	18,0	27,50	120301097	133,32				
MF 30 x 3,0	30,0	22,0	125	56	18,0	27,00	120301098	133,32				
MF 32 x 1	32,0	22,0	90	22	18,0	31,00	120301099	133,32				

MF Metric fine thread / ISO DIN 13

Efficient internal thread cutting.

The short structural type makes that tap usable by machine and hand.

A Hand-Tap-Set includes 2 taps:

Taper Tap

Finish Tap

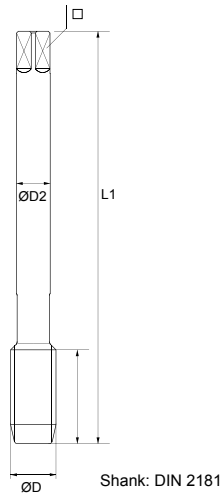

Hand Tap Sets for general use

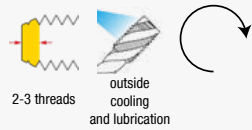
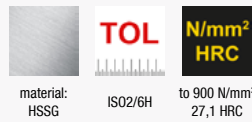
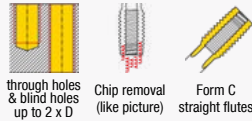

Hand Tap Sets for general use Left Hand

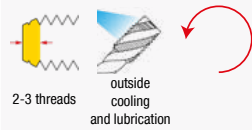
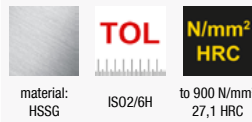
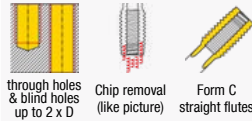

Hand Tap Sets HSSE for higher demands

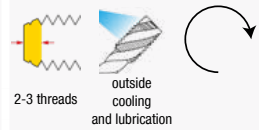
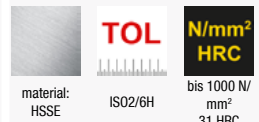
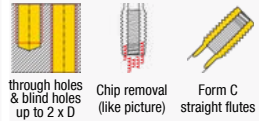

MF	D1	D2	L1	L2	□		No.	€	No.	€	No.	€
MF 32 x 1,5	32,0	22,0	90	22	18,0	30,50	120301100	133,32				
MF 32 x 2,0	32,0	22,0	90	22	18,0	30,00	120301101	133,32				
MF 32 x 3,0	32,0	22,0	125	56	18,0	29,00	120301102	133,32				
MF 33 x 1,5	33,0	25,0	100	25	20,0	31,50	120301103	133,32				
MF 33 x 2,0	33,0	25,0	100	25	20,0	31,00	120301104	163,72				
MF 33 x 3,0	33,0	25,0	125	56	20,0	30,00	120301105	163,72				
MF 34 x 1	34,0	28,0	100	25	22,0	33,00	120301106	163,72				
MF 34 x 1,5	34,0	28,0	100	25	22,0	32,50	120301107	163,72				
MF 34 x 2,0	34,0	28,0	125	40	22,0	32,00	120301108	163,72				
MF 35 x 1	35,0	28,0	100	25	22,0	34,00	120301109	163,72				
MF 35 x 1,5	35,0	28,0	100	25	22,0	33,50	120301110	163,72				
MF 35 x 2	35,0	28,0	125	40	22,0	33,00	120301111	163,72				
MF 36 x 1	36,0	28,0	100	25	22,0	35,00	120301112	170,74				
MF 36 x 1,5	36,0	28,0	100	25	22,0	34,50	120301113	170,74				
MF 36 x 2,0	36,0	28,0	125	40	22,0	34,00	120301114	170,74				
MF 36 x 3,0	36,0	28,0	125	40	22,0	33,00	120301115	170,74				
MF 37 x 1,5	37,0	28,0	100	25	22,0	35,50	120301116	212,84				
MF 38 x 1	38,0	28,0	100	25	22,0	37,00	120301117	212,84				
MF 38 x 1,5	38,0	28,0	100	25	22,0	36,50	120301118	212,84				
MF 38 x 2	38,0	28,0	125	40	22,0	36,00	120301119	212,84				
MF 38 x 3	38,0	28,0	125	40	22,0	35,00	120301120	212,84				
MF 39 x 1,5	39,0	32,0	110	25	24,0	37,50	120301121	212,84				
MF 39 x 2,0	39,0	32,0	125	40	24,0	37,00	120301122	212,84				
MF 39 x 3,0	39,0	32,0	125	40	24,0	36,00	120301123	212,84				
MF 40 x 1	40,0	32,0	110	25	24,0	39,00	120301124	212,84				
MF 40 x 1,5	40,0	32,0	110	25	24,0	38,50	120301125	212,84				
MF 40 x 2,0	40,0	32,0	125	40	24,0	38,00	120301126	212,84				
MF 40 x 3,0	40,0	32,0	125	40	24,0	37,00	120301127	212,84				
MF 42 x 1	42,0	32,0	110	25	24,0	41,00	120301128	212,84				
MF 42 x 1,5	42,0	32,0	110	25	24,0	40,50	120301129	212,84				
MF 42 x 2,0	42,0	32,0	125	40	24,0	40,00	120301130	222,21				
MF 42 x 3,0	42,0	32,0	125	40	24,0	39,00	120301131	222,21				
MF 44 x 1,5	44,0	36,0	110	25	29,0	42,50	120301132	250,27				

MF Metric fine thread / ISO DIN 13

Efficient internal thread cutting.

The short structural type makes that tap usable by machine and hand.

A Hand-Tap-Set includes 2 taps:

Taper Tap

Finish Tap

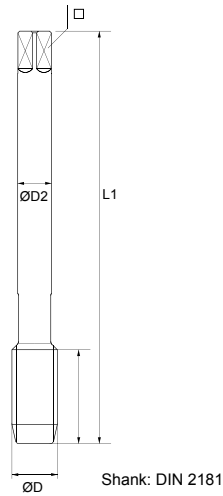

Hand Tap Sets for general use

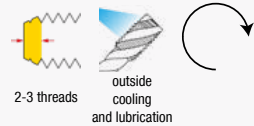
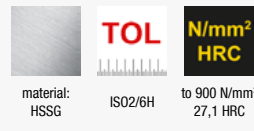
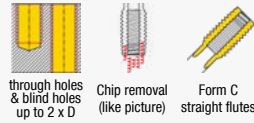

Hand Tap Sets for general use Left Hand

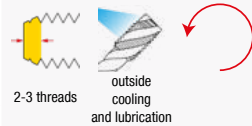
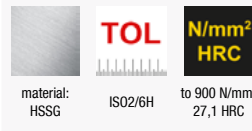
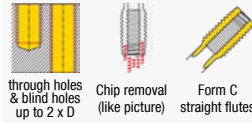

Hand Tap Sets HSSE for higher demands

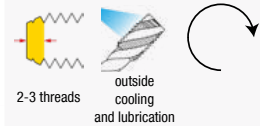
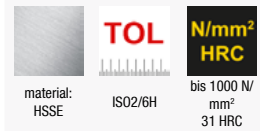
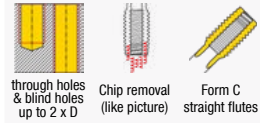

MF	D1	D2	L1	L2	□		No.	€	No.	€	No.	€
MF 44 x 2	44,0	36,0	125	40	29,0	42,00	120301133	250,27				
MF 45 x 1	45,0	36,0	110	25	29,0	44,00	120301134	250,27				
MF 45 x 1,5	45,0	36,0	110	25	29,0	43,50	120301135	250,27				
MF 45 x 2,0	45,0	36,0	125	40	29,0	43,00	120301136	250,27				
MF 45 x 3,0	45,0	36,0	125	40	29,0	42,00	120301137	250,27				
MF 46 x 1,5	46,0	36,0	140	40	29,0	45,50	120301138	250,27				
MF 48 x 1	48,0	36,0	140	40	29,0	47,00	120301139	299,39				
MF 48 x 1,5	48,0	36,0	140	40	29,0	46,50	120301140	299,39				
MF 48 x 2,0	48,0	36,0	140	40	29,0	46,00	120301141	299,39				
MF 48 x 3,0	48,0	36,0	140	40	29,0	45,00	120301142	299,39				
MF 50 x 1,5	50,0	36,0	140	40	29,0	48,50	120301143	327,43				
MF 50 x 2,0	50,0	36,0	140	40	29,0	48,00	120301144	327,43				
MF 50 x 3,0	50,0	36,0	140	40	29,0	47,00	120301145	327,43				
MF 52 x 1,5	52,0	40,0	140	40	32,0	50,50	120301146	392,93				
MF 52 x 2,0	52,0	40,0	140	40	32,0	50,00	120301147	392,93				
MF 52 x 3,0	52,0	40,0	140	40	32,0	49,00	120301148	392,93				
MF 54 x 1	54,0	40,0	140	32	32,0	53,00	120301149	425,67				
MF 54 x 1,5	54,0	40,0	140	32	32,0	52,50	120301150	425,67				
MF 54 x 2,0	54,0	40,0	140	36	32,0	52,00	120301151	425,67				
MF 54 x 3,0	54,0	40,0	140	40	32,0	51,00	120301152	425,67				
MF 54 x 4,0	54,0	40,0	180	50	32,0	50,00	120301153	425,67				
MF 55 x 1,5	55,0	40,0	140	32	32,0	53,50	120301154	486,47				
MF 55 x 2,0	55,0	40,0	140	36	32,0	53,00	120301155	486,47				
MF 55 x 3,0	55,0	40,0	140	40	32,0	52,00	120301156	486,47				
MF 55 x 4,0	55,0	40,0	180	50	32,0	51,00	120301157	486,47				
MF 56 x 1	56,0	40,0	140	32	32,0	55,00	120301158	540,29				
MF 56 x 1,5	56,0	40,0	140	32	32,0	54,50	120301159	547,28				
MF 56 x 2,0	56,0	40,0	140	36	32,0	54,00	120301160	547,28				
MF 56 x 3,0	56,0	40,0	140	40	32,0	53,00	120301161	547,28				
MF 56 x 4,0	56,0	40,0	180	50	32,0	52,00	120301162	547,28				
MF 58 x 1	58,0	45,0	160	32	35,0	57,00	120301163	584,71				
MF 58 x 1,5	58,0	45,0	160	32	35,0	56,50	120301164	556,66				
MF 58 x 2,0	58,0	45,0	160	36	35,0	56,00	120301165	556,66				
MF 58 x 3,0	58	45	160	40	35	55	120301166	556,66				

MF Metric fine thread / ISO DIN 13

Efficient internal thread cutting.

The short structural type makes that tap usable by machine and hand.

A Hand-Tap-Set includes 2 taps:

Taper Tap

Finish Tap

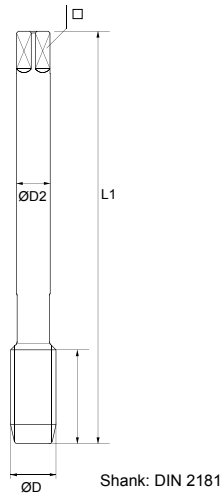

Hand Tap Sets for general use

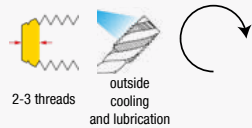
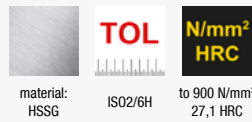
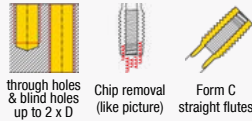

Hand Tap Sets for general use Left Hand

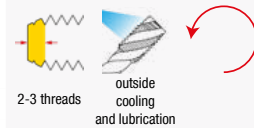
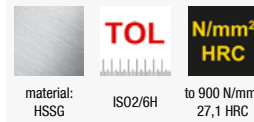
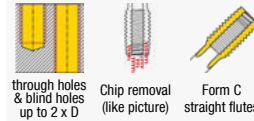

Hand Tap Sets HSSE for higher demands

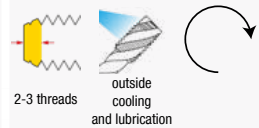
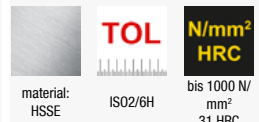
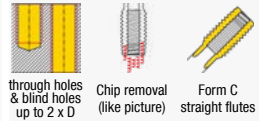

MF	D1	D2	L1	L2	□		No.	€	No.	€	No.	€
MF 58 x 4,0	58	45	200	55	35	54	120301167	556,66				
MF 60 x 1,5	60	45	160	34	35	58,5	120301168	582,39				
MF 60 x 2,0	60	45	160	36	35	58	120301169	582,39				
MF 60 x 3,0	60	45	160	40	35	57	120301170	582,39				
MF 60 x 4,0	60	45	200	55	35	56	120301171	582,39				
MF 62 x 1,5	62	50	160	34	39	60,5	120301172	666,61				
MF 62 x 2,0	62	50	160	36	39	60	120301173	666,61				
MF 62 x 3,0	62	50	180	45	39	59	120301174	666,61				
MF 62 x 4,0	62	50	220	55	39	58	120301175	666,61				
MF 63 x 1,5	63	50	160	32	39	61,5	120301176	685,31				
MF 64 x 1,5	64	50	160	34	39	62,5	120301177	685,31				
MF 64 x 2,0	64	50	160	36	39	62	120301178	685,31				
MF 64 x 3,0	64	50	180	45	39	61	120301179	685,31				
MF 64 x 4,0	64	50	220	60	39	60	120301180	696,99				
MF 65 x 1,5	65	50	160	34	39	63,5	120301181	725,03				
MF 65 x 2,0	65	50	160	36	39	63	120301182	725,03				
MF 65 x 3,0	65	50	180	45	39	62	120301183	725,03				
MF 65 x 4,0	65	50	220	60	39	61	120301184	725,03				
MF 68 x 1,5	68	50	160	36	39	66,5	120301185	748,44				
MF 68 x 2,0	68	50	160	40	39	66	120301186	748,44				
MF 68 x 3,0	68	50	180	50	39	65	120301187	748,44				
MF 68 x 4,0	68	50	220	60	39	64	120301188	748,44				
MF 70 x 1,5	70	50	160	36	39	68,5	120301189	1.414,74				
MF 70 x 2,0	70	50	160	40	39	68	120301190	1.414,74				
MF 70 x 3,0	70	50	200	50	39	67	120301191	1.604,21				
MF 70 x 4,0	70	50	240	60	39	66	120301192	1.604,21				
MF 72 x 1,5	72	50	160	36	39	70,5	120301193	1.414,74				
MF 72 x 2,0	72	50	160	40	39	70	120301194	1.414,74				
MF 72 x 3,0	72	50	200	50	39	69	120301195	1.604,21				
MF 72 x 4,0	72	50	240	60	39	68	120301196	1.604,21				
MF 74 x 1,5	74	50	160	36	39	72,5	120301197	1.566,32				
MF 74 x 2,0	74	50	160	40	39	72	120301198	1.566,32				
MF 74 x 3,0	74	50	200	50	39	71	120301199	1.844,21				
MF 74 x 4,0	74	50	240	60	39	70	120301200	1.844,21				

MF Metric fine thread / ISO DIN 13

Efficient internal thread cutting.

The short structural type makes that tap usable by machine and hand.

A Hand-Tap-Set includes 2 taps:

- Taper Tap
- Finish Tap

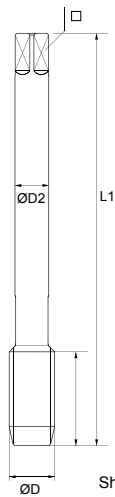

Shank: DIN 2181

Hand Tap Sets for general use

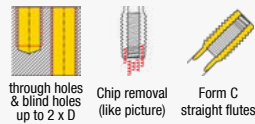

material: HSSG
TOL ISO2/6H
N/mm² HRC to 900 N/mm² 27,1 HRC

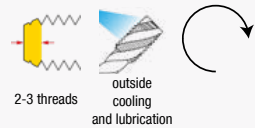

Hand Tap Sets for general use Left Hand

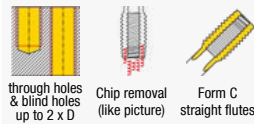

material: HSSG
TOL ISO2/6H
N/mm² HRC to 900 N/mm² 27,1 HRC

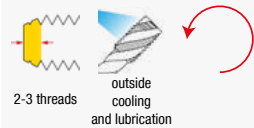

Hand Tap Sets HSSE for higher demands

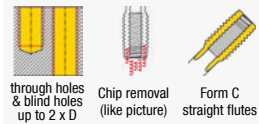

material: HSSE
TOL ISO2/6H
N/mm² HRC bis 1000 N/mm² 31 HRC

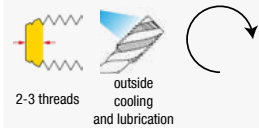

MF	D1	D2	L1	L2	□		No.	€	No.	€	No.	€
MF 75 x 1,5	75	50	160	36	39	73,5	120301201	1.578,95				
MF 75 x 2,0	75	50	160	40	39	73	120301202	1.578,95				
MF 75 x 3,0	75	50	200	50	39	72	120301203	1.856,84				
MF 75 x 4,0	75	50	240	60	39	71	120301204	1.856,84				
MF 76 x 1,5	76	50	160	36	39	74,5	120301205	1.604,21				
MF 76 x 2,0	76	50	160	40	39	74	120301206	1.604,21				
MF 76 x 3,0	76	50	220	50	39	73	120301207	1.983,16				
MF 76 x 4,0	76	50	260	60	39	72	120301208	1.983,16				
MF 78 x 1,5	78	50	160	36	39	76,5	120301209	1.604,21				
MF 78 x 2,0	78	50	160	40	39	76	120301210	1.604,21				
MF 78 x 3,0	78	50	220	55	39	75	120301211	1.983,16				
MF 78 x 4,0	78	50	260	65	39	74	120301212	1.983,16				
MF 80 x 1,5	80	50	160	36	39	78,5	120301213	1.743,16				
MF 80 x 2,0	80	50	160	40	39	78	120301214	1.743,16				
MF 80 x 3,0	80	50	220	55	39	77	120301215	2.172,63				
MF 80 x 4,0	80	50	260	65	39	76	120301216	2.172,63				
MF 82 x 1,5	82	50	160	36	39	80,5	120301217	1.743,16				
MF 82 x 2,0	82	50	160	40	39	80	120301218	1.743,16				
MF 82 x 3,0	82	50	220	55	39	79	120301219	2.172,63				
MF 82 x 4,0	82	50	260	65	39	78	120301220	2.172,63				
MF 84 x 1,5	84	50	160	36	39	82,5	120301221	2.033,68				
MF 84 x 2,0	84	50	160	40	39	82	120301222	2.033,68				
MF 84 x 3,0	84	50	220	55	39	81	120301223	2.456,84				
MF 84 x 4,0	84	50	260	65	39	80	120301224	2.456,84				
MF 85 x 1,5	85	50	160	36	39	83,5	120301225	2.652,63				
MF 85 x 2,0	85	50	160	40	39	83	120301226	2.652,63				
MF 85 x 3,0	85	50	220	55	39	82	120301227	3.284,21				
MF 85 x 4,0	85	50	260	65	39	81	120301228	3.284,21				
MF 86 x 1,5	86	50	160	36	39	84,5	120301229	2.652,63				
MF 86 x 2,0	86	50	160	40	39	84	120301230	2.652,63				
MF 86 x 3,0	86	50	220	55	39	83	120301231	3.233,68				
MF 86 x 4,0	86	50	260	65	39	82	120301232	3.233,68				
MF 88 x 1,5	88	50	160	38	39	86,5	120301233	2.905,26				
MF 88 x 2,0	88	50	160	40	39	86	120301234	2.905,26				

MF Metric fine thread / ISO DIN 13

Efficient internal thread cutting.

The short structural type makes that tap usable by machine and hand.

A Hand-Tap-Set includes 2 taps:

Taper Tap

Finish Tap

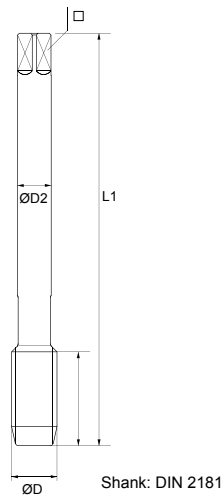

Hand Tap Sets for general use

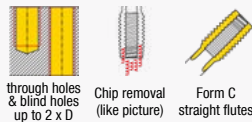

material: HSSG
TOL ISO2/6H
N/mm² HRC to 900 N/mm² 27,1 HRC

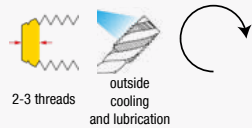

Hand Tap Sets for general use Left Hand

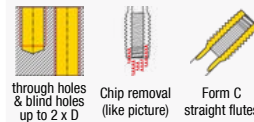

material: HSSG
TOL ISO2/6H
N/mm² HRC to 900 N/mm² 27,1 HRC

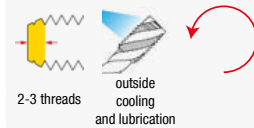

Hand Tap Sets HSSE for higher demands

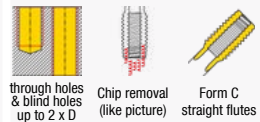

material: HSSE
TOL ISO2/6H
N/mm² HRC bis 1000 N/mm² 31 HRC

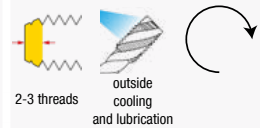

MF	D1	D2	L1	L2	□		No.	€	No.	€	No.	€
MF 88 x 3,0	88	50	220	55	39	85	120301235	3.334,74				
MF 88 x 4,0	88	50	260	65	39	84	120301236	3.334,74				
MF 90 x 1,5	90	50	160	38	39	88,5	120301237	3.031,58				
MF 90 x 2,0	90	50	160	40	39	88	120301238	2.981,05				
MF 90 x 3,0	90	50	220	55	39	87	120301239	3.562,11				
MF 90 x 4,0	90	50	260	65	39	86	120301240	3.562,11				
MF 92 x 1,5	92	56	180	40	44	90,5	120301241	3.031,58				
MF 92 x 2,0	92	56	180	45	44	90	120301242	3.031,58				
MF 92 x 3,0	92	56	240	60	44	89	120301243	3.840,00				
MF 92 x 4,0	92	56	280	70	44	88	120301244	3.840,00				
MF 95 x 1,5	95	56	180	40	44	93,5	120301245	3.258,95				
MF 95 x 2,0	95	56	180	45	44	93	120301246	3.258,95				
MF 95 x 3,0	95	56	240	60	44	92	120301247	4.294,74				
MF 95 x 4,0	95	56	280	70	44	91	120301248	4.193,68				
MF 96 x 1,5	96	56	180	40	44	94,5	120301249	3.284,21				
MF 96 x 2,0	96	56	180	45	44	94	120301250	3.284,21				
MF 96 x 3,0	96	56	240	60	44	93	120301251	4.294,74				
MF 96 x 4,0	96	56	280	70	44	92	120301252	4.294,74				
MF 98 x 1,5	98	56	180	40	44	96,5	120301253	3.536,84				
MF 98 x 2,0	98	56	180	45	44	96	120301254	3.536,84				
MF 98 x 3,0	98	56	240	60	44	95	120301255	4.673,68				
MF 98 x 4,0	98	56	280	70	44	94	120301256	4.673,68				
MF 100 x 1,5	100	56	180	45	44	98,5	120301257	4.042,11				
MF 100 x 2,0	100	56	180	50	44	98	120301258	4.042,11				
MF 100 x 3,0	100	56	240	65	44	97	120301259	4.926,32				
MF 100 x 4,0	100	56	280	75	44	96	120301260	4.926,32				
MF 105 x 1,5	105	56	180	45	44	103,5	120301261	4.370,53				
MF 105 x 2,0	105	56	180	50	44	103	120301262	4.370,53				
MF 105 x 3,0	105	56	240	65	44	102	120301263	5.305,26				
MF 105 x 4,0	105	56	280	75	44	101	120301264	5.305,26				
MF 110 x 1,5	110	56	180	45	44	108,5	120301265	4.800,00				
MF 110 x 2,0	110	56	180	50	44	108	120301266	4.800,00				
MF 110 x 3,0	110	56	240	65	44	107	120301267	5.936,84				
MF 110 x 4,0	110	56	280	75	44	106	120301268	5.936,84				

MF Metric fine thread / ISO DIN 13

- ✓ Tap for machine use in through hole.
- ✓ The spiral point pushes the chips ahead.

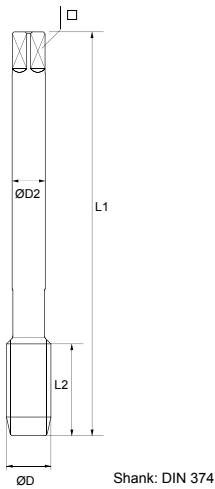

Machine Tap for general use

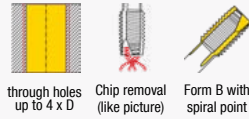

material: HSSE
TOL ISO2/6H
to 900 N/mm² 27,1 HRC

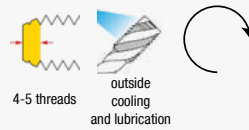

DIN 374



Machine Tap for general use

Left-hand thread

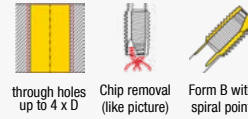

material: HSSE
TOL ISO2/6H
to 900 N/mm² 27,1 HRC

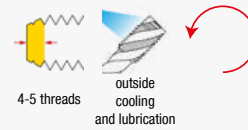

DIN 374



MF

	D1	D2	L1	L2	□	⚙️	No.	€	No.	€
MF 3 x 0,35	3,0	2,2	56	9	-	2,65	120401001	14,27	120402001	33,06
MF 4 x 0,35	4,0	2,8	63	10	2,1	3,65	120401002	14,27	120402002	33,06
MF 4 x 0,5	4,0	2,8	63	10	2,1	3,50	120401003	14,27	120402003	33,06
MF 5 x 0,5	5,0	3,5	70	12	2,7	4,50	120401004	14,27	120402004	33,06
MF 5 x 0,75	5,0	3,5	70	12	2,7	4,25	120401005	14,27	120402005	33,06
MF 6 x 0,5	6,0	4,5	80	14	3,4	5,50	120401006	14,27	120402006	33,06
MF 6 x 0,75	6,0	4,5	80	14	3,4	5,20	120401007	14,27	120402007	33,06
MF 7 x 0,75	7,0	5,5	80	14	4,3	6,20	120401008	14,27	120402008	33,06
MF 8 x 0,5	8,0	6,0	80	19	4,9	7,50	120401009	14,27	120402009	33,06
MF 8 x 0,75	8,0	6,0	80	19	4,9	7,20	120401010	14,27	120402010	33,06
MF 8 x 1,0	8,0	6,0	90	22	4,9	7,00	120401011	14,27	120402011	33,06
MF 9 x 0,75	9,0	7,0	80	19	5,5	8,25	120401012	14,27	120402012	33,06
MF 9 x 1,0	9,0	7,0	90	22	5,5	8,00	120401013	14,27	120402013	33,06
MF 10 x 0,75	10,0	7,0	90	20	5,5	9,20	120401014	16,50	120402014	36,73
MF 10 x 1,0	10,0	7,0	90	20	5,5	9,00	120401015	16,50	120402015	36,73
MF 10 x 1,25	10,0	7,0	100	24	5,5	8,80	120401016	16,50	120402016	36,73
MF 11 x 1,0	11,0	8,0	90	20	6,2	10,00	120401017	22,68	120402017	51,42
MF 11 x 1,25	11,0	8,0	90	22	6,2	10,80	120401018	22,68	120402018	51,42
MF 12 x 0,75	12,0	9,0	100	22	7,0	10,20	120401019	22,68	120402019	51,42
MF 12 x 1,0	12,0	9,0	100	22	7,0	11,00	120401020	22,68	120402020	51,42
MF 12 x 1,25	12,0	9,0	100	22	7,0	10,80	120401021	22,68	120402021	51,42
MF 12 x 1,5	12,0	9,0	100	22	7,0	10,50	120401022	22,68	120402022	51,42
MF 13 x 1,0	13,0	11,0	100	22	9,0	12,00	120401023	29,23	120402023	62,44
MF 13 x 1,5	13,0	11,0	100	22	9,0	11,50	120401024	29,23	120402024	62,44
MF 14 x 0,75	14,0	11,0	100	22	9,0	13,20	120401025	29,23	120402025	62,44
MF 14 x 1,0	14,0	11,0	100	22	9,0	13,00	120401026	29,23	120402026	62,44
MF 14 x 1,25	14,0	11,0	100	22	9,0	12,80	120401027	29,23	120402027	62,44
MF 14 x 1,5	14,0	11,0	100	22	9,0	12,50	120401028	29,23	120402028	62,44
MF 15 x 1,0	15,0	12,0	100	22	9,0	14,00	120401029	32,16	120402029	72,41
MF 15 x 1,5	15,0	12,0	100	22	9,0	13,50	120401030	32,16	120402030	72,41
MF 16 x 1,0	16,0	12,0	100	22	9,0	15,00	120401031	32,75	120402031	72,41
MF 16 x 1,25	16,0	12,0	100	22	9,0	14,80	120401032	32,75	120402032	72,41
MF 16 x 1,5	16,0	12,0	100	22	9,0	14,50	120401033	32,54	120402033	72,41
MF 18 x 1,0	18,0	14,0	110	25	11,0	17,00	120401034	42,95	120402034	87,11
MF 18 x 1,25	18,0	14,0	110	25	11,0	16,80	120401035	42,95	120402035	87,11

MF Metric fine thread / ISO DIN 13

- ☑ Tap for machine use in through hole.
- ☑ The spiral point pushes the chips ahead.

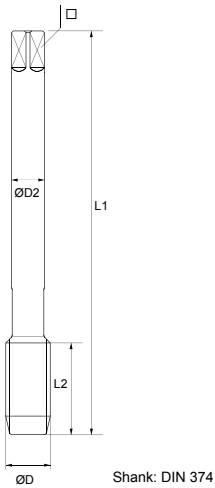

Machine Tap for general use

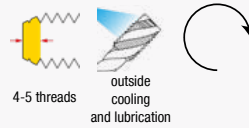
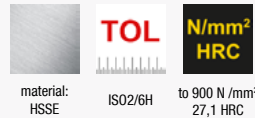
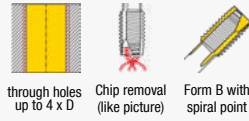

Machine Tap for general use

Left-hand thread

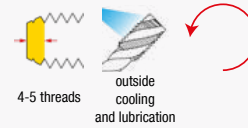
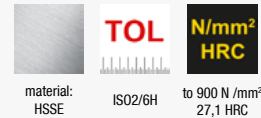
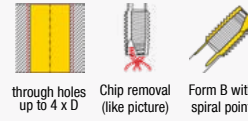

MF	D1	D2	L1	L2	□	🔩	No.	€	No.	€
MF 18 x 1,5	18,0	14,0	110	25	11,0	16,50	120401036	42,95	120402036	87,11
MF 18 x 2,0	18,0	14,0	125	34	11,0	16,00	120401037	42,95	120402037	87,11
MF 20 x 1,0	20,0	16,0	125	25	12,0	19,00	120401038	48,00	120402038	96,03
MF 20 x 1,25	20,0	16,0	125	25	12,0	18,80	120401039	48,00	120402039	96,03
MF 20 x 1,5	20,0	16,0	125	25	12,0	18,50	120401040	48,00	120402040	96,03
MF 20 x 2,0	20,0	16,0	140	34	12,0	18,00	120401041	48,00	120402041	96,03
MF 21 x 1,5	21,0	16,0	125	25	12,0	19,50	120401042	48,00	120402042	96,03
MF 22 x 1,0	22,0	18,0	125	25	14,5	21,00	120401043	58,11	120402043	119,64
MF 22 x 1,25	22,0	18,0	125	25	14,5	20,80	120401044	58,11	120402044	119,64
MF 22 x 1,5	22,0	18,0	125	25	14,5	20,50	120401045	58,11	120402045	119,64
MF 22 x 2,0	22,0	18,0	140	34	14,5	20,00	120401046	58,11	120402046	119,64
MF 23 x 1,5	23,0	18,0	125	25	14,5	21,50	120401047	68,21	120402047	138,53
MF 24 x 1,0	24,0	18,0	140	28	14,5	23,00	120401048	68,21	120402048	138,53
MF 24 x 1,25	24,0	18,0	140	28	14,5	23,80	120401049	68,21	120402049	138,53
MF 24 x 1,5	24,0	18,0	140	28	14,5	22,50	120401050	68,21	120402050	138,53
MF 24 x 2,0	24,0	18,0	140	28	14,5	22,00	120401051	68,21	120402051	138,53
MF 25 x 1,0	25,0	18,0	140	28	14,5	24,00	120401052	72,00	120402052	138,53
MF 25 x 1,5	25,0	18,0	140	28	14,5	23,50	120401053	72,00	120402053	138,53
MF 26 x 1,0	26,0	18,0	140	28	14,5	25,00	120401054	72,00	120402054	138,53
MF 26 x 1,5	26,0	18,0	140	28	14,5	24,50	120401055	72,00	120402055	138,53
MF 26 x 2,0	26,0	18,0	140	28	14,5	24,00	120401056	72,00	120402056	138,53
MF 27 x 1,0	27,0	20,0	140	28	16,0	26,00	120401057	86,32	120402057	175,26
MF 27 x 1,5	27,0	20,0	140	28	16,0	25,50	120401058	86,32	120402058	175,26
MF 27 x 2,0	27,0	20,0	140	28	16,0	25,00	120401059	86,32	120402059	175,26
MF 28 x 1,0	28,0	20,0	140	28	16,0	27,00	120401060	86,32	120402060	175,26
MF 28 x 1,5	28,0	20,0	140	28	16,0	26,50	120401061	86,32	120402061	175,26
MF 28 x 2,0	28,0	20,0	140	28	16,0	26,00	120401062	86,32	120402062	175,26
MF 29 x 1,5	29,0	22,0	150	28	18,0	27,50	120401063	97,26	120402063	200,45
MF 30 x 1,0	30,0	22,0	150	28	18,0	29,00	120401064	97,26	120402064	200,45
MF 30 x 1,5	30,0	22,0	150	28	18,0	28,50	120401065	97,26	120402065	200,45
MF 30 x 2,0	30,0	22,0	150	28	18,0	28,00	120401066	97,26	120402066	200,45
MF 30 x 2,5	30,0	22,0	180	45	18,0	27,50	120401067	97,26	120402067	200,45
MF 30 x 3,0	30,0	22,0	180	45	18,0	27,00	120401068	97,26	120402068	200,45
MF 32 x 1,5	32,0	22,0	150	28	18,0	30,50	120401069	118,95	120402069	247,68
MF 32 x 2,0	32,0	22,0	150	28	18,0	30,00	120401070	118,95	120402070	247,68

MF Metric fine thread / ISO DIN 13

- ✓ Tap for machine use in through hole.
- ✓ The spiral point pushes the chips ahead.

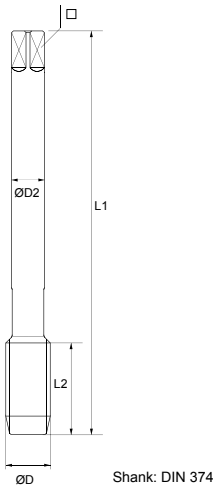

Machine Tap for general use

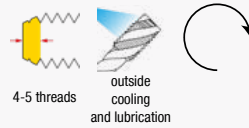
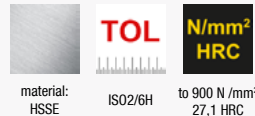
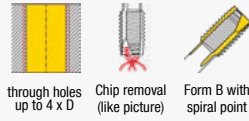

Machine Tap for general use

Left-hand thread

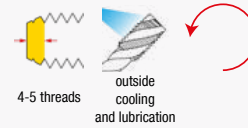
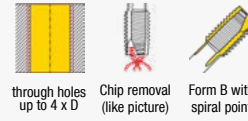

MF

	D1	D2	L1	L2	□		No.	€	No.	€
MF 32 x 3,0	32,0	22,0	180	50	18,0		120401071	118,95	120402071	247,68
MF 33 x 1,5	33,0	25,0	160	30	20,0		120401072	118,95	120402072	247,68
MF 33 x 2,0	33,0	25,0	160	30	20,0		120401073	118,95	120402073	247,68
MF 33 x 3,0	33,0	25,0	180	50	20,0		120401074	118,95	120402074	247,68
MF 34 x 1,5	34,0	28,0	170	30	22,0		120401075	118,95	120402075	247,68
MF 34 x 2,0	34,0	28,0	170	30	22,0		120401076	118,95	120402076	247,68
MF 35 x 1,5	35,0	28,0	170	30	22,0		120401077	118,95	120402077	247,68
MF 36 x 1,5	36,0	28,0	170	30	22,0		120401078	149,47	120402078	310,64
MF 36 x 2,0	36,0	28,0	170	30	22,0		120401079	149,47	120402079	310,64
MF 36 x 3,0	36,0	28,0	200	56	22,0		120401080	149,47	120402080	310,64
MF 38 x 1,5	38,0	28,0	170	30	22,0		120401081	157,89	120402081	327,44
MF 39 x 1,5	39,0	32,0	170	30	24,0		120401082	157,89	120402082	327,44
MF 39 x 2,0	39,0	32,0	170	30	24,0		120401083	157,89	120402083	327,44
MF 39 x 3,0	39,0	32,0	200	60	24,0		120401084	157,89	120402084	327,44
MF 40 x 1,5	40,0	32,0	170	30	24,0		120401085	174,74	120402085	358,92
MF 40 x 2,0	40,0	32,0	170	30	24,0		120401086	174,74	120402086	358,92
MF 40 x 3,0	40,0	32,0	200	60	24,0		120401087	174,74	120402087	358,92
MF 42 x 1,5	42,0	32,0	170	30	24,0		120401088	197,89	120402088	400,90
MF 42 x 2,0	42,0	32,0	170	30	24,0		120401089	197,89	120402089	400,90
MF 42 x 3,0	42,0	32,0	200	60	24,0		120401090	197,89	120402090	400,90
MF 45 x 1,5	45,0	36,0	180	32	29,0		120401091	230,53	120402091	472,26
MF 45 x 2,0	45,0	36,0	180	32	29,0		120401092	230,53	120402092	472,26
MF 45 x 3,0	45,0	36,0	200	50	29,0		120401093	230,53	120402093	472,26
MF 48 x 1,5	48,0	36,0	190	32	29,0		120401094	275,79	120402094	569,86
MF 48 x 2,0	48,0	36,0	190	32	29,0		120401095	275,79	120402095	569,86
MF 48 x 3,0	48,0	36,0	225	50	29,0		120401096	275,79	120402096	569,86
MF 50 x 1,5	50,0	36,0	190	32	29,0		120401097	324,21	120402097	661,17
MF 50 x 2,0	50,0	36,0	190	32	29,0		120401098	324,21	120402098	661,17
MF 50 x 3,0	50,0	36,0	225	50	29,0		120401099	324,21	120402099	661,17
MF 52 x 1,5	52,0	40,0	190	32	32,0		120401100	353,68	120402100	730,43
MF 52 x 2,0	52,0	40,0	190	32	32,0		120401101	353,68	120402101	730,43
MF 52 x 3,0	52,0	40,0	225	50	32,0		120401102	353,68	120402102	730,43
MF 63 x 1,5	63,0	50,0	275	50	39,0		120401103	629,47		

MF Metric fine thread / ISO DIN 13

- ✓ Tap for machine use in through hole.
- ✓ The spiral point pushes the chips ahead.

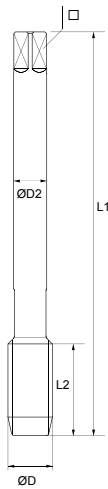

Shank: DIN 374

Machine Tap for high-alloyed steels

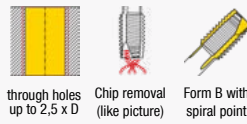

through holes up to 2,5 x D
 Chip removal (like picture)
 Form B with spiral point

material: HSSE TiN
 TOL ISO2/6H
 N/mm² HRC to 1300
 N/mm² 41 HRC

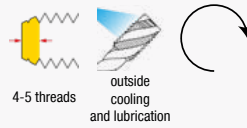

DIN 374



Machine Tap for stainless steels

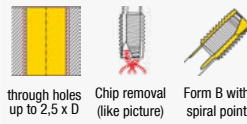

through holes up to 2,5 x D
 Chip removal (like picture)
 Form B with spiral point

material: HSSE TiAlN
 TOL ISO2/6H
 N/mm² HRC to 1300
 N/mm² 41 HRC

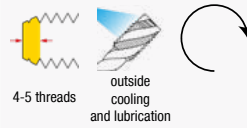

DIN 374



Machine Tap for aluminum

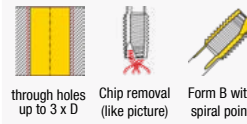

through holes up to 3 x D
 Chip removal (like picture)
 Form B with spiral point

material: HSSE TiN
 TOL ISO2/6H
 N/mm² HRC to 900
 N/mm² 27,1 HRC

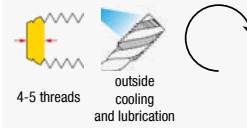

DIN 374



MF	D1	D2	L1	L2	□	🔩	No.	€	No.	€	No.	€
MF 6 x 0,75	6,0	4,5	80	14	3,4	5,20	120404001	32,50	120405001	39,47	120407001	39,47
MF 8 x 1,0	8,0	6,0	90	22	4,9	7,00	120404002	34,22	120405002	42,38	120407002	42,38
MF 10 x 1,0	10,0	7,0	90	20	5,5	9,00	120404003	35,81	120405003	44,41	120407003	44,41
MF 10 x 1,25	10,0	7,0	100	24	5,5	8,80	120404004	44,03	120405004	49,64	120407004	49,64
MF 12 x 1,0	12,0	9,0	100	22	7,0	11,00	120404005	48,80	120405005	55,43	120407005	55,43
MF 12 x 1,25	12,0	9,0	100	22	7,0	10,80	120404006	49,92	120405006	60,08	120407006	60,08
MF 12 x 1,5	12,0	9,0	100	22	7,0	10,50	120404007	50,66	120405007	52,97	120407007	52,97
MF 14 x 1,25	14,0	11,0	100	22	9,0	12,80	120404008	54,12	120405008	68,93	120407008	68,93
MF 14 x 1,5	14,0	11,0	100	22	9,0	12,50	120404009	66,93	120405009	68,93	120407009	68,93
MF 16 x 1,5	16,0	12,0	100	22	9,0	14,50	120404010	81,75	120405010	76,62	120407010	76,62
MF 18 x 1,5	18,0	14,0	110	25	11,0	16,50	120404011	85,99	120405011	95,05	120407011	95,05
MF 20 x 1,5	20,0	16,0	125	25	12,0	18,50	120404012	95,36	120405012	103,91	120407012	103,91

MF Metric fine thread / ISO DIN 13

- ✓ Tap for machine use in through hole.
- ✓ The spiral point pushes the chips ahead.

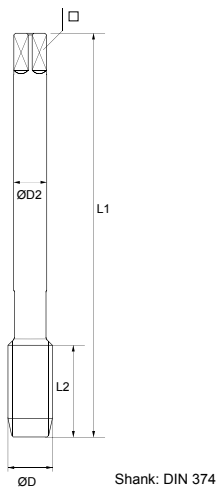

Machine Tap for special alloys (Inconel, Hastelloy etc.)

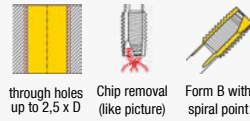

through holes up to 2,5 x D
Chip removal (like picture)
Form B with spiral point

material: HSSE-PM TiAlN
TOL ISO2/6H
N/mm² HRC to 1200 N/mm² 38 HRC

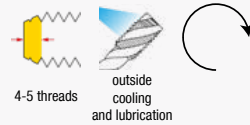

Machine Tap with longer tool life time

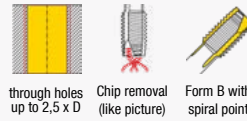

through holes up to 2,5 x D
Chip removal (like picture)
Form B with spiral point

material: HSSE TIN
TOL ISO2/6H
N/mm² HRC to 900 N/mm² 27,1 HRC

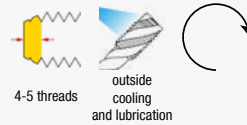

Machine Tap for general use oversized (diameter)

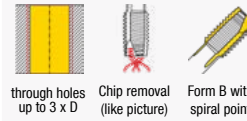

through holes up to 3 x D
Chip removal (like picture)
Form B with spiral point

material: HSSE
TOL ISO2/6H
N/mm² HRC to 900 N/mm² 27,1 HRC

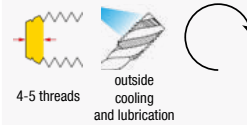

MF	D1	D2	L1	L2	□	☑	No.	€	No.	€	No.	€
											Tol. 6G: threads with large clearance	
MF 6 x 0,75	6,0	4,5	80	14	3,4	5,20			120425001	32,50	120417001	41,75
MF 8 x 1,0	8,0	6,0	90	22	4,9	7,00	120412001	69,10	120425002	34,22	120417002	42,11
MF 10 x 1,0	10,0	7,0	90	20	5,5	9,00	120412002	73,61	120425003	35,81	120417003	43,73
MF 10 x 1,25	10,0	7,0	100	24	5,5	8,80	120412003	73,61	120425004	44,03	120417004	52,91
MF 12 x 1,0	12,0	9,0	100	22	7,0	11,00	120412004	116,43	120425005	48,80		
MF 12 x 1,25	12,0	9,0	100	22	7,0	10,80	120412005	106,89	120425006	49,92		
MF 12 x 1,5	12,0	9,0	100	22	7,0	10,50	120412006	106,89	120425007	50,66	120417005	47,15
MF 14 x 1,25	14,0	11,0	100	22	9,0	12,80			120425008	54,12		
MF 14 x 1,5	14,0	11,0	100	22	9,0	12,50	120412007	144,87	120425009	66,93	120417006	65,87
MF 16 x 1,5	16,0	12,0	100	22	9,0	14,50	120412008	158,90	120425010	81,75		
MF 18 x 1,5	18,0	14,0	110	25	11,0	16,50	120412009	211,81	120425011	85,99		
MF 20 x 1,5	20,0	16,0	125	25	12,0	18,50	120412010	278,58	120425012	95,36		

Machine Taps - Form C (straight flutes) for through holes and blind holes

MF Metric fine thread / ISO DIN 13

- ✓ Tap for machine use in through hole and blind hole.
- ✓ The short lead-in chamfer makes that tap universal in application. The flutes can hold the most part of the chips.

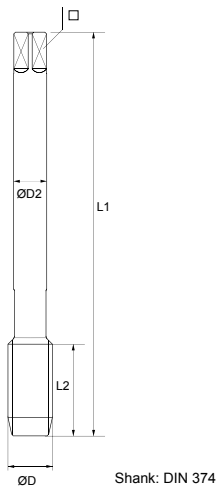

Machine Tap for general use

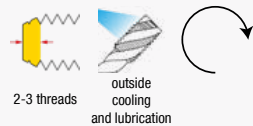
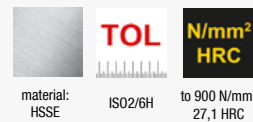
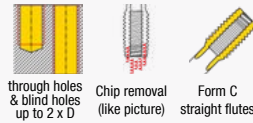

Machine Tap for general use Left-hand thread

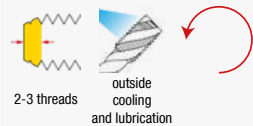
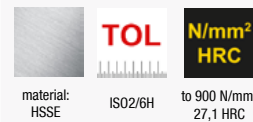
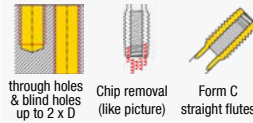

Machine Tap with longer tool life time

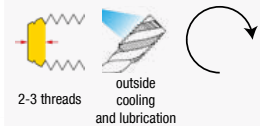
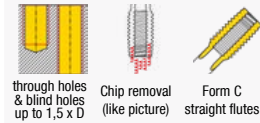

MF	D1	D2	L1	L2	□		No.	€	No.	€	No.	€
MF 4 x 0,35	4,0	2,8	63	10	2,1	3,65	120501001	13,72				
MF 5 x 0,5	5,0	3,5	70	12	2,7	4,50	120501002	12,75				
MF 6 x 0,5	6,0	4,5	80	14	3,4	5,50				120504001	47,23	
MF 6 x 0,75	6,0	4,5	80	14	3,4	5,20	120501003	12,75	120502001	30,00	120504002	28,40
MF 7 x 0,75	7,0	5,5	80	14	4,3	6,20					120504003	53,38
MF 8 x 0,75	8,0	6,0	80	19	4,9	7,20	120501004	12,75				
MF 8 x 1,0	8,0	6,0	90	22	4,9	7,00	120501005	12,75	120502002	30,00	120504004	49,61
MF 10 x 0,5	10,0	7,0	90	20	5,5	9,50					120504005	81,56
MF 10 x 1,0	10,0	7,0	90	20	5,5	9,00	120501006	15,32	120502003	32,85	120504006	41,20
MF 10 x 1,25	10,0	7,0	100	24	5,5	8,80	120501007	15,32	120502004	48,20	120504007	42,71
MF 12 x 0,75	12,0	9,0	100	22	7,0	10,20					120504008	85,33
MF 12 x 1,0	12,0	9,0	100	22	7,0	11,00	120501008	19,88			120504009	46,98
MF 12 x 1,25	12,0	9,0	100	22	7,0	10,80	120501009	20,46	120502005	49,70	120504010	53,19
MF 12 x 1,5	12,0	9,0	100	22	7,0	10,50	120501010	19,88	120502006	53,10	120504011	49,98
MF 14 x 1,0	14,0	11,0	100	22	9,0	13,00	120501011	24,68			120504012	82,95
MF 14 x 1,25	14,0	11,0	100	22	9,0	12,80	120501012	24,68			120504013	78,78
MF 14 x 1,5	14,0	11,0	100	22	9,0	12,50	120501013	24,68	120502007	56,30	120504014	62,02
MF 16 x 1,0	16,0	12,0	100	22	9,0	15,00	120501014	29,23			120504015	71,67
MF 16 x 1,25	16,0	12,0	100	22	9,0	14,80					120504016	120,66
MF 16 x 1,5	16,0	12,0	100	22	9,0	14,50	120501015	29,23	120502008	72,15	120504017	75,43
MF 18 x 1,0	18,0	14,0	110	25	11,0	17,00	120501016	37,36				
MF 18 x 1,5	18,0	14,0	110	25	11,0	16,50	120501017	37,36	120502009	125,00	120504018	79,35
MF 18 x 2,0	18,0	14,0	125	34	11,0	16,00	120501018	37,36				
MF 20 x 1,0	20,0	16,0	125	25	12,0	19,00	120501019	40,72				
MF 20 x 1,25	20,0	16,0	125	25	12,0	18,80	120501020	40,72				
MF 20 x 1,5	20,0	16,0	125	25	12,0	18,50	120501021	40,72	120502010	138,95	120504019	95,83
MF 20 x 2,0	20,0	16,0	140	34	12,0	18,00	120501022	40,72				
MF 22 x 1,0	22,0	18,0	125	25	14,5	21,00	120501023	51,63				
MF 22 x 1,5	22,0	18,0	125	25	14,5	20,50	120501024	51,63			120504020	116,54
MF 22 x 2,0	22,0	18,0	140	34	14,5	20,00	120501025	51,63				

Machine Taps - Form C (straight flutes) for through holes and blind holes

MF Metric fine thread / ISO DIN 13

- ✓ Tap for machine use in through hole and blind hole.
- ✓ The short lead-in chamfer makes that tap universal in application. The flutes can hold the most part of the chips.

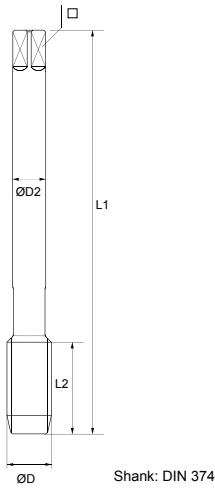

Machine Tap for general use

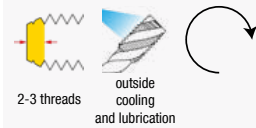
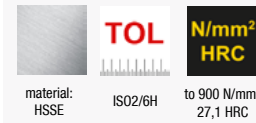
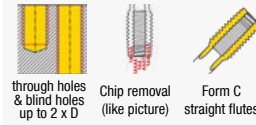

Machine Tap for general use Left-hand thread

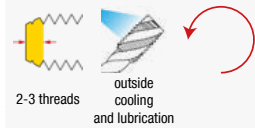
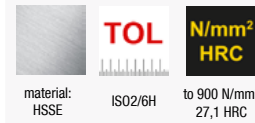
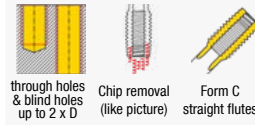

Machine Tap with longer tool life time

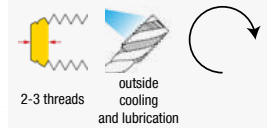
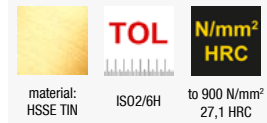
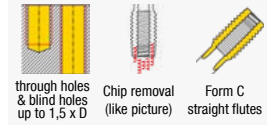

MF	D1	D2	L1	L2	□		No.	€	No.	€	No.	€
MF 24 x 1,0	24,0	18,0	140	28	14,5	23,00	120501026	60,45				
MF 24 x 1,5	24,0	18,0	140	28	14,5	22,50	120501027	60,45				
MF 24 x 2,0	24,0	18,0	140	28	14,5	22,00	120501028	60,45				
MF 25 x 1,0	25,0	18,0	140	28	14,5	24,00	120501029	60,45				
MF 26 x 1,5	26,0	18,0	140	28	14,5	24,50	120501030	60,45				
MF 27 x 1,5	27,0	20,0	140	28	16,0	25,50	120501031	75,56				
MF 27 x 2,0	27,0	20,0	140	28	16,0	25,00	120501032	75,56				
MF 28 x 1,5	28,0	20,0	140	28	16,0	26,50	120501033	75,56				
MF 30 x 1,5	30,0	22,0	150	28	18,0	28,50	120501034	87,11				
MF 30 x 2,0	30,0	22,0	150	28	18,0	28,00	120501035	87,11				
MF 32 x 1,5	32,0	22,0	150	28	18,0	30,50	120501036	111,24				
MF 32 x 2,0	32,0	22,0	150	28	18,0	30,00	120501037	111,24				
MF 33 x 2,0	33,0	25,0	160	30	20,0	31,00	120501038	111,24				
MF 35 x 1,5	35,0	28,0	170	30	22,0	33,50	120501039	111,24				
MF 36 x 1,5	36,0	28,0	170	30	22,0	34,50	120501040	138,53				
MF 36 x 2,0	36,0	28,0	170	30	22,0	34,00	120501041	138,53				
MF 38 x 1,5	38,0	28,0	170	30	22,0	36,50	120501042	149,03				
MF 40 x 1,5	40,0	32,0	170	30	24,0	38,50	120501043	161,62				
MF 42 x 1,5	42,0	32,0	170	30	24,0	40,50	120501044	179,46				
MF 45 x 1,5	45,0	36,0	180	32	29,0	43,50	120501045	209,89				
MF 48 x 1,5	48,0	36,0	190	32	29,0	46,50	120501046	255,02				
MF 50 x 1,5	50,0	36,0	190	32	29,0	48,50	120501047	293,85				
MF 52 x 1,5	52,0	40,0	190	32	32,0	50,50	120501048	323,24				

Machine Taps - Form C (straight flutes) for through holes and blind holes

MF Metric fine thread / ISO DIN 13

- ✓ Tap for machine use in through hole and blind hole.
- ✓ The short lead-in chamfer makes that tap universal in application. The flutes can hold the most part of the chips.

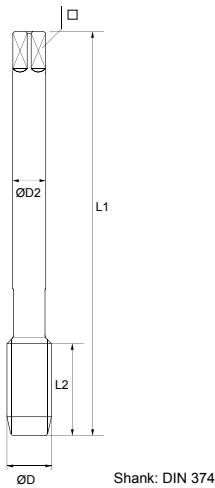

Machine Tap for cast materials

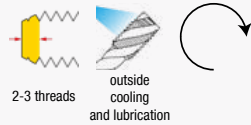
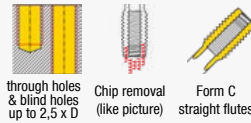

DIN 374



Machine Tap for brass (short-chipping)

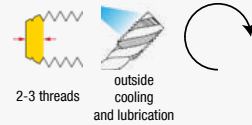
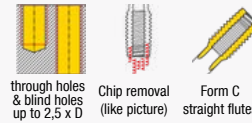

DIN 374



MF	D1	D2	L1	L2	□	✎	No.	€	No.	€
MF 4 x 0,5	4,0	2,8	63	10	2,1	3,50	120510001	49,61	120509001	46,52
MF 5 x 0,5	5,0	3,5	70	12	2,7	4,50	120510002	49,61	120509002	46,52
MF 6 x 0,75	6,0	4,5	80	14	3,4	5,20	120510003	50,21	120509003	47,06
MF 8 x 1,0	8,0	6,0	90	22	4,9	7,00	120510004	53,38	120509004	50,04
MF 10 x 1,0	10,0	7,0	90	20	5,5	9,00	120510005	43,14	120509005	52,85
MF 10 x 1,25	10,0	7,0	100	24	5,5	8,80	120510006	56,36	120509006	52,85
MF 12 x 1,25	12,0	9,0	100	22	7,0	10,80	120510007	58,14	120509007	64,00
MF 12 x 1,5	12,0	9,0	100	22	7,0	10,50	120510008	54,87	120509008	64,00
MF 14 x 1,25	14,0	11,0	100	22	9,0	12,80	120510009	95,26	120509009	89,30
MF 14 x 1,5	14,0	11,0	100	22	9,0	12,50	120510010	65,03	120509010	82,24
MF 16 x 1,5	16,0	12,0	100	22	9,0	14,50	120510011	68,26	120509011	90,79
MF 18 x 1,5	18,0	14,0	110	25	11,0	16,50	120510012	83,11	120509012	108,47
MF 20 x 1,5	20,0	16,0	125	25	12,0	18,50	120510013	98,11	120509013	120,75

MF Metric fine thread / ISO DIN 13

- ✓ Tap for machine use in blind holes.
- ✓ The fast spiral flutes provide good chip removal from the blind hole.

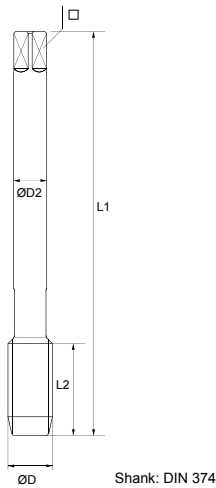

Machine Tap for general use

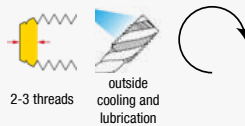
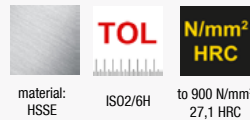
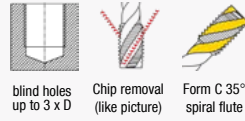

Machine Tap for general use

Left-hand thread

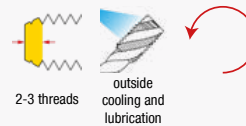
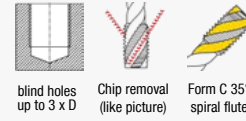

MF	D1	D2	L1	L2	□	🔩	No.	€	No.	€
MF 3 x 0,35	3,0	2,2	56	5	-	2,65	120601001	16,14	120602001	36,73
MF 4 x 0,35	4,0	2,8	63	5	2,1	3,65	120601002	16,14	120602002	36,73
MF 4 x 0,5	4,0	2,8	63	5	2,1	3,50	120601003	16,14	120602003	36,73
MF 5 x 0,5	5,0	3,5	70	5	2,7	4,50	120601004	16,14	120602004	36,73
MF 5 x 0,75	5,0	3,5	70	8	2,7	4,25	120601005	16,14	120602005	36,73
MF 6 x 0,5	6,0	4,5	80	5	3,4	5,50	120601006	16,14	120602006	36,73
MF 6 x 0,75	6,0	4,5	80	8	3,4	5,20	120601007	16,14	120602007	36,73
MF 7 x 0,75	7,0	5,5	80	8	4,3	6,20	120601008	16,14	120602008	36,73
MF 8 x 0,5	8,0	6,0	80	8	4,9	7,50	120601009	16,14	120602009	36,73
MF 8 x 0,75	8,0	6,0	80	8	4,9	7,20	120601010	16,14	120602010	36,73
MF 8 x 1,0	8,0	6,0	90	10	4,9	7,00	120601011	16,14	120602011	36,73
MF 9 x 0,75	9,0	7,0	80	10	5,5	8,25	120601012	16,14	120602012	36,73
MF 9 x 1,0	9,0	7,0	90	10	5,5	8,00	120601013	16,14	120602013	36,73
MF 10 x 0,75	10,0	7,0	90	10	5,5	9,20	120601014	19,06	120602014	44,50
MF 10 x 1,0	10,0	7,0	90	10	5,5	9,00	120601015	19,06	120602015	44,50
MF 10 x 1,25	10,0	7,0	100	16	5,5	8,80	120601016	19,06	120602016	44,50
MF 11 x 1,0	11,0	8,0	90	11	6,2	10,00	120601017	24,56	120602017	56,88
MF 11 x 1,25	11,0	8,0	90	14	6,2	10,80	120601018	24,56	120602018	56,88
MF 12 x 0,75	12,0	9,0	100	10	7,0	10,20	120601019	24,56	120602019	56,88
MF 12 x 1,0	12,0	9,0	100	11	7,0	11,00	120601020	24,56	120602020	56,88
MF 12 x 1,25	12,0	9,0	100	15	7,0	10,80	120601021	24,56	120602021	56,88
MF 12 x 1,5	12,0	9,0	100	15	7,0	10,50	120601022	24,56	120602022	56,88
MF 13 x 1,0	13,0	11,0	100	11	9,0	12,00	120601023	30,05	120602023	69,48
MF 13 x 1,5	13,0	11,0	100	15	9,0	11,50	120601024	30,05	120602024	69,48
MF 14 x 0,75	14,0	11,0	100	10	9,0	13,20	120601025	30,05	120602025	69,48
MF 14 x 1,0	14,0	11,0	100	11	9,0	13,00	120601026	30,05	120602026	69,48
MF 14 x 1,25	14,0	11,0	100	15	9,0	12,80	120601027	30,05	120602027	69,48
MF 14 x 1,5	14,0	11,0	100	15	9,0	12,50	120601028	30,05	120602028	69,48
MF 15 x 1,0	15,0	12,0	100	12	9,0	14,00	120601029	34,85	120602029	79,76
MF 15 x 1,5	15,0	12,0	100	15	9,0	13,50	120601030	34,85	120602030	79,76
MF 16 x 1,0	16,0	12,0	100	12	9,0	15,00	120601031	34,85	120602031	79,76
MF 16 x 1,25	16,0	12,0	100	15	9,0	14,80	120601032	34,85	120602032	79,76
MF 16 x 1,5	16,0	12,0	100	15	9,0	14,50	120601033	34,85	120602033	79,76
MF 18 x 1,0	18,0	14,0	110	13	11,0	17,00	120601034	47,75	120602034	98,86
MF 18 x 1,25	18,0	14,0	110	15	11,0	16,80	120601035	47,75	120602035	98,86

MF Metric fine thread / ISO DIN 13

- ✓ Tap for machine use in blind holes.
- ✓ The fast spiral flutes provide good chip removal from the blind hole.

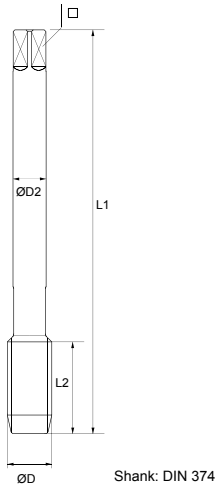

Machine Tap for general use

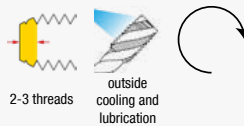
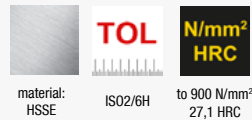
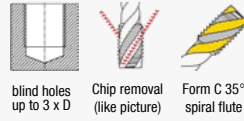

Machine Tap for general use

Left-hand thread

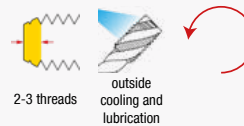
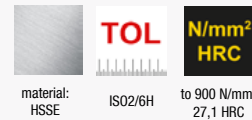
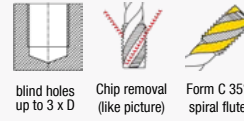

MF	D1	D2	L1	L2	□	Image	No.	€	No.	€
MF 18 x 1,5	18,0	14,0	110	17	11,0	16,50	120601036	47,75	120602036	98,86
MF 18 x 2,0	18,0	14,0	125	20	11,0	16,00	120601037	47,75	120602037	98,86
MF 20 x 1,0	20,0	16,0	125	14	12,0	19,00	120601038	52,89	120602038	110,72
MF 20 x 1,25	20,0	16,0	125	17	12,0	18,80	120601039	52,89	120602039	110,72
MF 20 x 1,5	20,0	16,0	125	17	12,0	18,50	120601040	52,89	120602040	110,72
MF 20 x 2,0	20,0	16,0	140	20	12,0	18,00	120601041	52,89	120602041	110,72
MF 21 x 1,5	21,0	16,0	125	17	12,0	19,50	120601042	52,89	120602042	110,72
MF 22 x 1,0	22,0	18,0	125	14	14,5	21,00	120601043	64,23	120602043	132,23
MF 22 x 1,25	22,0	18,0	125	17	14,5	20,80	120601044	64,23	120602044	132,23
MF 22 x 1,5	22,0	18,0	125	17	14,5	20,50	120601045	64,23	120602045	132,23
MF 22 x 2,0	22,0	18,0	140	20	14,5	20,00	120601046	64,23	120602046	132,23
MF 23 x 1,5	23,0	18,0	125	17	14,5	21,50	120601047	76,82	120602047	159,52
MF 24 x 1,0	24,0	18,0	140	15	14,5	23,00	120601048	76,82	120602048	159,52
MF 24 x 1,25	24,0	18,0	140	17	14,5	23,80	120601049	76,82	120602049	159,52
MF 24 x 1,5	24,0	18,0	140	20	14,5	22,50	120601050	76,82	120602050	159,52
MF 24 x 2,0	24,0	18,0	140	20	14,5	22,00	120601051	76,82	120602051	159,52
MF 25 x 1,0	25,0	18,0	140	15	14,5	24,00	120601052	80,81	120602052	159,52
MF 25 x 1,5	25,0	18,0	140	20	14,5	23,50	120601053	80,81	120602053	159,52
MF 26 x 1,0	26,0	18,0	140	15	14,5	25,00	120601054	80,81	120602054	159,52
MF 26 x 1,5	26,0	18,0	140	20	14,5	24,50	120601055	80,81	120602055	159,52
MF 26 x 2,0	26,0	18,0	140	20	14,5	24,00	120601056	80,81	120602056	159,52
MF 27 x 1,0	27,0	20,0	140	15	16,0	26,00	120601057	93,19	120602057	193,10
MF 27 x 1,5	27,0	20,0	140	20	16,0	25,50	120601058	92,35	120602058	193,10
MF 27 x 2,0	27,0	20,0	140	20	16,0	25,00	120601059	92,35	120602059	193,10
MF 28 x 1,0	28,0	20,0	140	15	16,0	27,00	120601060	92,35	120602060	193,10
MF 28 x 1,5	28,0	20,0	140	20	16,0	26,50	120601061	92,35	120602061	193,10
MF 28 x 2,0	28,0	20,0	140	20	16,0	26,00	120601062	92,35	120602062	193,10
MF 29 x 1,5	29,0	22,0	150	22	18,0	27,50	120601063	106,00	120602063	219,34
MF 30 x 1,0	30,0	22,0	150	17	18,0	29,00	120601064	106,00	120602064	219,34
MF 30 x 1,5	30,0	22,0	150	22	18,0	28,50	120601065	106,00	120602065	219,34
MF 30 x 2,0	30,0	22,0	150	22	18,0	28,00	120601066	106,00	120602066	219,34
MF 30 x 2,5	30,0	22,0	180	27	18,0	27,50	120601067	106,00	120602067	219,34
MF 30 x 3,0	30,0	22,0	180	30	18,0	27,00	120601068	106,00	120602068	219,34
MF 32 x 1,5	32,0	22,0	150	22	18,0	30,50	120601069	131,18	120602069	273,91
MF 32 x 2,0	32,0	22,0	150	22	18,0	30,00	120601070	131,18	120602070	273,91

Machine Taps - Form C (with spiral flutes) for blind holes

MF Metric fine thread / ISO DIN 13

- ✓ Tap for machine use in blind holes.
- ✓ The fast spiral flutes provide good chip removal from the blind hole.

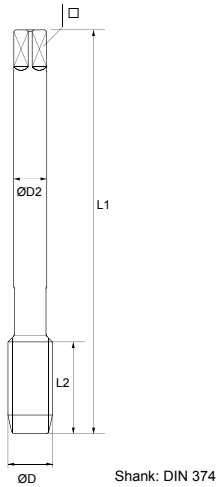

Machine Tap for general use

blind holes up to 3 x D
Chip removal (like picture)
Form C 35° spiral flute

material: HSSE
ISO2/6H
to 900 N/mm²
27,1 HRC

2-3 threads
outside cooling and lubrication

DIN 374

Machine Tap for general use Left-hand thread

blind holes up to 3 x D
Chip removal (like picture)
Form C 35° spiral flute

material: HSSE
ISO2/6H
to 900 N/mm²
27,1 HRC

2-3 threads
outside cooling and lubrication

DIN 374

MF	D1	D2	L1	L2	□	🔩	No.	€	No.	€
MF 32 x 3,0	32,0	22,0	180	30	18,0	29,00	120601071	131,18	120602071	273,91
MF 33 x 1,5	33,0	25,0	160	24	20,0	31,50	120601072	131,18	120602072	273,91
MF 33 x 2,0	33,0	25,0	160	24	20,0	31,00	120601073	131,18	120602073	273,91
MF 33 x 3,0	33,0	25,0	180	30	20,0	30,00	120601074	131,18	120602074	273,91
MF 34 x 1,5	34,0	28,0	170	24	22,0	32,50	120601075	131,18	120602075	273,91
MF 34 x 2,0	34,0	28,0	170	24	22,0	32,00	120601076	131,18	120602076	273,91
MF 35 x 1,5	35,0	28,0	170	24	22,0	33,50	120601077	131,18	120602077	273,91
MF 36 x 1,5	36,0	28,0	170	24	22,0	34,50	120601078	166,87	120602078	346,33
MF 36 x 2,0	36,0	28,0	170	24	22,0	34,00	120601079	166,87	120602079	346,33
MF 36 x 3,0	36,0	28,0	200	30	22,0	33,00	120601080	166,87	120602080	346,33
MF 38 x 1,5	38,0	28,0	170	24	22,0	36,50	120601081	175,26	120602081	362,07
MF 39 x 1,5	39,0	32,0	170	25	24,0	37,50	120601082	175,26	120602082	362,07
MF 39 x 2,0	39,0	32,0	170	25	24,0	37,00	120601083	175,26	120602083	362,07
MF 39 x 3,0	39,0	32,0	200	30	24,0	36,00	120601084	175,26	120602084	362,07
MF 40 x 1,5	40,0	32,0	170	25	24,0	38,50	120601085	194,15	120602085	393,55
MF 40 x 2,0	40,0	32,0	170	25	24,0	38,00	120601086	194,15	120602086	393,55
MF 40 x 3,0	40,0	32,0	200	30	24,0	37,00	120601087	194,15	120602087	393,55
MF 42 x 1,5	42,0	32,0	170	25	24,0	40,50	120601088	217,24	120602088	444,98
MF 42 x 2,0	42,0	32,0	170	25	24,0	40,00	120601089	217,24	120602089	444,98
MF 42 x 3,0	42,0	32,0	200	30	24,0	39,00	120601090	217,24	120602090	444,98
MF 45 x 1,5	45,0	36,0	180	27	29,0	43,50	120601091	253,97	120602091	522,64
MF 45 x 2,0	45,0	36,0	180	27	29,0	43,00	120601092	253,97	120602092	522,64
MF 45 x 3,0	45,0	36,0	200	30	29,0	42,00	120601093	253,97	120602093	522,64
MF 48 x 1,5	48,0	36,0	190	27	29,0	46,50	120601094	302,25	120602094	623,39
MF 48 x 2,0	48,0	36,0	190	27	29,0	46,00	120601095	302,25	120602095	623,39
MF 48 x 3,0	48,0	36,0	225	33	29,0	45,00	120601096	302,25	120602096	623,39
MF 50 x 1,5	50,0	36,0	190	27	29,0	48,50	120601097	352,62	120602097	726,24
MF 50 x 2,0	50,0	36,0	190	27	29,0	48,00	120601098	352,62	120602098	726,24
MF 50 x 3,0	50,0	36,0	225	33	29,0	47,00	120601099	352,62	120602099	726,24
MF 52 x 1,5	52,0	40,0	190	27	32,0	50,50	120601100	390,40	120602100	795,50
MF 52 x 2,0	52,0	40,0	190	27	32,0	50,00	120601101	390,40	120602101	795,50
MF 52 x 3,0	52,0	40,0	225	33	32,0	49,00	120601102	390,40	120602102	795,50
MF 63 x 1,5	63,0	50,0	275	40	39,0	61,50	120601103	667,47		

Machine Taps - Form C (with spiral flutes) for blind holes

MF Metric fine thread / ISO DIN 13

- ✓ Tap for machine use in blind holes.
- ✓ The fast spiral flutes provide good chip removal from the blind hole.

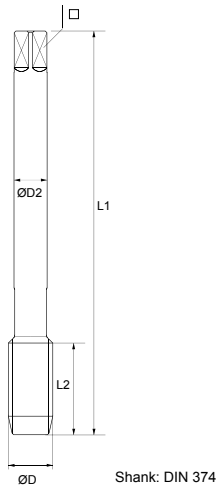

Machine Tap und for high-alloyed steels

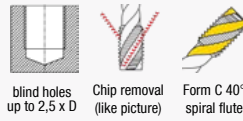

blind holes up to 2,5 x D
Chip removal (like picture)
Form C 40° spiral flute

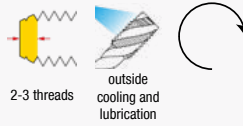

Machine Tap PRO for stainless steels with high tool life time

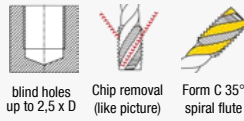

blind holes up to 2,5 x D
Chip removal (like picture)
Form C 35° spiral flute

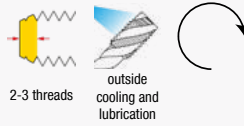

Machine Tap for special alloys (Inconel, Hastelloy etc.)

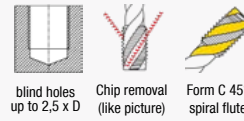

blind holes up to 2,5 x D
Chip removal (like picture)
Form C 45° spiral flute

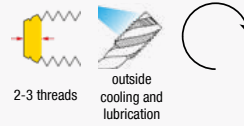

MF	D1	D2	L1	L2	□	□	No.	€	No.	€	No.	€
MF 6 x 0,75	6,0	4,5	80	8	3,4	5,20	120604001	30,13	120605001	48,92		
MF 8 x 1,0	8,0	6,0	90	10	4,9	7,00	120604002	34,11	120605002	52,51	120612001	85,66
MF 10 x 1,0	10,0	7,0	90	10	5,5	9,00	120604003	45,66	120605003	55,04	120612002	94,12
MF 10 x 1,25	10,0	7,0	100	16	5,5	8,80	120604004	52,58	120605004	61,51	120612003	98,97
MF 12 x 1,0	12,0	9,0	100	11	7,0	11,00	120604005	57,93	120605005	68,70	120612004	132,80
MF 12 x 1,25	12,0	9,0	100	15	7,0	10,80	120604006	63,47	120605006	74,46	120612005	115,00
MF 12 x 1,5	12,0	9,0	100	15	7,0	10,50	120604007	65,65	120605007	65,65	120612006	112,30
MF 14 x 1,5	14,0	11,0	100	15	9,0	12,50	120604008	85,42	120605008	85,42	120612007	142,35
MF 16 x 1,5	16,0	12,0	100	15	9,0	14,50	120604009	85,42	120605009	85,42	120612008	170,24
MF 18 x 1,5	18,0	14,0	110	17	11,0	16,50	120604010	94,96	120605010	94,96	120612009	189,32
MF 20 x 1,5	20,0	16,0	125	17	12,0	18,50	120604011	117,80	120605011	117,80	120612010	218,46
MF 22 x 1,5	22,0	18,0	125	17	14,5	20,50	120604012	128,77	120605012	128,77		

MF Metric fine thread / ISO DIN 13

- ✓ Tap for machine use in blind holes.
- ✓ The fast spiral flutes provide good chip removal from the blind hole.

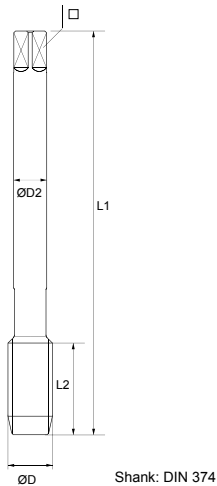

Machine Tap for general use oversized (diameter)

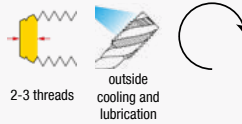
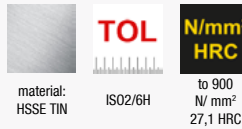
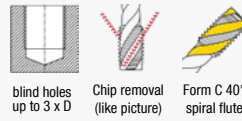

MF	D1	D2	L1	L2	□	☐	No.	€
----	----	----	----	----	---	---	-----	---

Tol. 6G:
threads with large clearance

MF 6 x 0,75	6,0	4,5	80	8	3,4	5,20	120617001	44,63
MF 8 x 1,0	8,0	6,0	90	10	4,9	7,00	120617002	44,63
MF 10 x 1,0	10,0	7,0	90	10	5,5	9,00	120617003	46,61
MF 10 x 1,25	10,0	7,0	100	16	5,5	8,80	120617004	65,14
MF 12 x 1,5	12,0	9,0	100	15	7,0	10,50	120617005	52,91
MF 14 x 1,5	14,0	11,0	100	15	9,0	12,50	120617006	72,52

MF Metric fine thread / ISO DIN 13

Machine Forming Taps have following advantages:

- No chips
- Up to 20 times longer lifetime (compared to taps)
- Same forming tap for through and blind hole
- Wide range of materials can be processed
- Intersection of the thread is impossible
- Very high trueness
- Increased strength of the thread
- Higher surface quality
- Much higher cutting speed

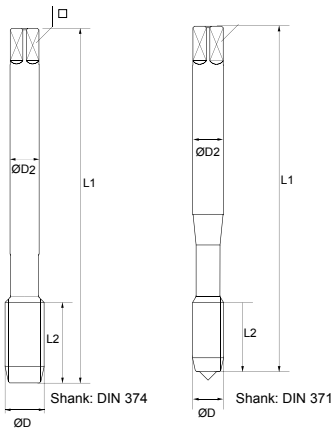

Machine Forming Taps for general use

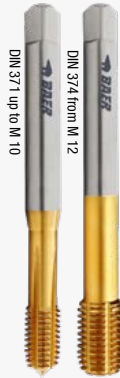
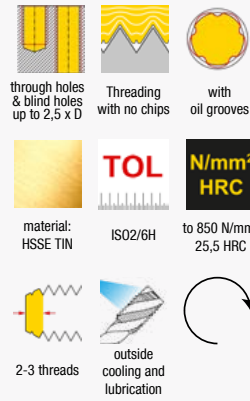

Machine Forming Taps for general use oversized (diameter)

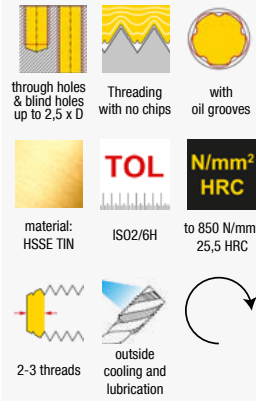

MF	D1	D2	L1	L2	□	✂	Tol. 6HX: standard tolerance		Tol. 6GX: threads with large clearance	
							No.	€	No.	€
MF 3 x 0,35	3,0	3,5	56	10	2,7	2,85	121101001	89,80	121117001	109,67
MF 4 x 0,5	4,0	4,5	63	12	3,4	3,80	121101002	56,63	121117002	100,86
MF 5 x 0,5	5,0	6,0	70	14	4,9	4,80	121101003	57,35	121117003	100,86
MF 6 x 0,75	6,0	6,0	80	16	4,9	5,65	121101004	56,63	121117004	99,37
MF 8 x 1,0	8,0	8,0	90	18	6,2	7,55	121101005	65,27	121117005	107,74
MF 10 x 1,0	10,0	10,0	90	18	8,0	9,55	121101006	75,58	121117006	114,40
MF 10 x 1,25	10,0	10,0	100	20	8,0	9,45	121101007	79,42	121117007	114,40
MF 12 x 1,0	12,0	9,0	100	22	7,0	11,55	121101008	89,26	121117008	141,65
MF 12 x 1,25	12,0	9,0	100	22	7,0	11,45	121101009	93,09	121117009	141,65
MF 12 x 1,5	12,0	9,0	100	22	7,0	11,30	121101010	86,61	121117010	141,65
MF 14 x 1,25	14,0	11,0	100	22	9,0	13,45	121101011	110,62	121117011	185,65
MF 14 x 1,5	14,0	11,0	100	22	9,0	13,30	121101012	103,68	121117012	185,65
MF 16 x 1,5	16,0	12,0	100	22	9,0	15,30	121101013	131,25	121117013	226,21
MF 18 x 1,5	18,0	14,0	110	22	11,0	17,30	121101014	168,44	121117014	268,29
MF 20 x 1,5	20,0	16,0	125	25	12,0	19,30	121101015	189,56	121117015	366,16

MF Metric fine thread / ISO DIN 13

Efficient internal thread cutting with batterypowered screwdriver (min. 7,5 Volt).

Application:

non abrasive material up to 900 N/mm² unalloyed and low alloyed steel

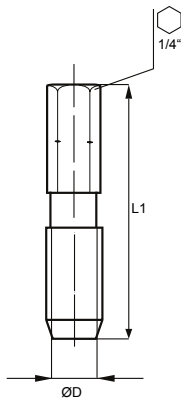

Bit-Taps
Form D for through holes and blind holes

through holes & blind holes up to 2 x D Chip removal (like picture) Form D straight flutes

material: HSSG ISO2/6H to 800 N/mm² 22,2 HRC

4-5 threads outside cooling and lubrication

MF	D1	L1	L2	Hex	Length	No.	€
MF 3 x 0,35	3,0	33,0	11	1/4"	2,65	121201001	*
MF 3,5 x 0,35	3,5	33,5	10	1/4"	3,15	121201002	*
MF 4 x 0,35	4,0	35,0	12	1/4"	3,65	121201003	*
MF 4 x 0,5	4,0	35,0	12	1/4"	3,50	121201004	*
MF 4,5 x 0,5	4,5	35,0	12	1/4"	4,00	121201005	*
MF 5 x 0,5	5,0	36,0	15	1/4"	4,50	121201006	*
MF 5 x 0,75	5,0	36,0	15	1/4"	4,25	121201007	*
MF 5,5 x 0,5	5,5	35,0	15	1/4"	5,00	121201008	*
MF 6 x 0,5	6,0	39,0	18	1/4"	5,50	121201009	*
MF 6 x 0,75	6,0	39,0	18	1/4"	5,20	121201010	*
MF 7 x 0,5	7,0	37,5	16	1/4"	6,50	121201011	*
MF 7 x 0,75	7,0	37,5	16	1/4"	6,20	121201012	*
MF 8 x 0,5	8,0	40,0	19	1/4"	7,50	121201013	*
MF 8 x 0,75	8,0	40,0	19	1/4"	7,20	121201014	*
MF 8 x 1	8,0	40,0	19	1/4"	7,00	121201015	*
MF 9 x 0,5	9,0	40,5	18	1/4"	8,50	121201016	*
MF 9 x 0,75	9,0	40,5	18	1/4"	8,25	121201017	*
MF 9 x 1	9,0	40,5	18	1/4"	8,00	121201018	*
MF 10 x 0,5	10,0	41,0	21	1/4"	9,50	121201019	*
MF 10 x 0,75	10,0	41,0	21	1/4"	9,20	121201020	*
MF 10 x 1,0	10,0	41,0	21	1/4"	9,00	121201021	*
MF 10 x 1,25	10,0	41,0	21	1/4"	8,80	121201022	*

* on request

Round Dies for general use

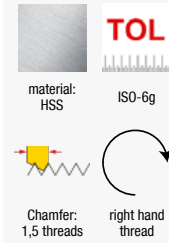

Round Dies for general use Left Hand

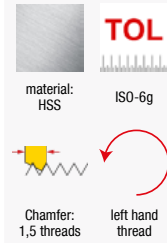

Round Dies for higher demands

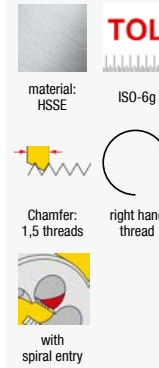

Round Dies for stainless steels

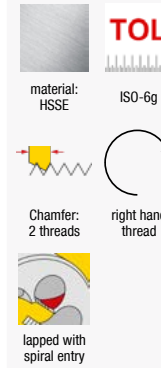

Round Dies undersized

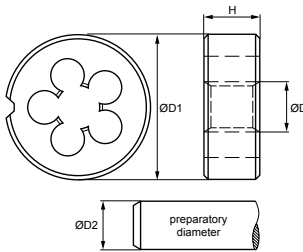
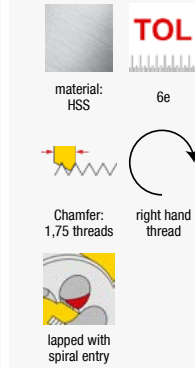

MF

	D	D1	H	D2	No.	€	No.	€	No.	€	No.	€	No.	€	D2 Tol. 6e
MF 2,5 x 0,35	2,5	16	5	2,44	121401001	15,22									
MF 2,6 x 0,35	2,6	16	5	2,54	121401002	15,22									
MF 3 x 0,35	3,0	20	5	2,94	121401003	12,42					121405001	35,42			
MF 3,5 x 0,35	3,5	20	5	3,44	121401004	12,42					121405002	43,86			
MF 4 x 0,35	4,0	20	5	3,94	121401005	12,42									
MF 4 x 0,5	4,0	20	5	3,93	121401006	12,42					121405003	24,98	121421001	86,85	3,84 mm
MF 4,5 x 0,5	4,5	20	5	4,43	121401007	12,42									
MF 5 x 0,5	5,0	20	5	4,93	121401008	12,42					121405004	24,98	121421002	86,85	4,83 mm
MF 5 x 0,75	5,0	20	7	4,91	121401010	12,42									
MF 5,5 x 0,5	5,5	20	5	5,43	121401009	12,42									
MF 6 x 0,5	6,0	20	5	5,93	121401011	12,42					121405005	24,98	121421003	71,81	5,83 mm
MF 6 x 0,75	6,0	20	7	5,90	121401012	10,74	121402001	16,37	121404001	15,11	121405006	24,98	121421004	66,80	5,81 mm
MF 7 x 0,5	7,0	25	9	6,93	121401013	13,47							121421005	88,50	6,83 mm
MF 7 x 0,75	7,0	25	9	6,90	121401014	13,47					121405007	30,85			
MF 8 x 0,5	8,0	25	9	7,93	121401015	13,47					121405008	30,85	121421006	116,24	7,82 mm
MF 8 x 0,75	8,0	25	9	7,90	121401016	11,26	121402002	19,65	121404002	19,94	121405009	30,85	121421007	83,51	7,80 mm
MF 8 x 1,0	8,0	25	9	7,83	121401017	11,26	121402003	19,65	121404003	19,94	121405010	30,85	121421008	63,46	7,78 mm
MF 9 x 0,5	9,0	25	9	8,93	121401018	16,95									
MF 9 x 0,75	9,0	25	9	8,90	121401019	16,95									
MF 9 x 1,0	9,0	25	9	8,88	121401020	16,95									
MF 10 x 0,5	10,0	30	11	9,93	121401021	16,95									
MF 10 x 0,75	10,0	30	11	9,90	121401022	16,95					121405011	37,99	121421009	115,24	9,79 mm
MF 10 x 1,0	10,0	30	11	9,88	121401023	12,95	121402004	24,56	121404004	22,56	121405012	37,99	121421010	71,15	9,77 mm
MF 10 x 1,25	10,0	30	11	9,86	121401024	12,95	121402005	24,56	121404005	22,56	121405013	37,99			
MF 11 x 1,0	11,0	30	11	10,88	121401025	19,47									
MF 11 x 1,25	11,0	30	11	10,86	121401026	19,47									
MF 12 x 0,5	12,0	38	10	11,93	121401027	19,47									
MF 12 x 0,75	12,0	38	10	11,90	121401028	19,47							121421011	119,57	11,78 mm
MF 12 x 1,0	12,0	38	10	11,88	121401029	16,53	121402006	31,93	121404006	39,04	121405014	46,28	121421012	93,52	11,76 mm
MF 12 x 1,25	12,0	38	10	11,86	121401030	16,53	121402007	31,93	121404007	39,04	121405015	46,28			
MF 12 x 1,5	12,0	38	10	11,85	121401031	16,00	121402008	31,93	121404008	39,04	121405016	46,28	121421013	87,84	11,73 mm
MF 13 x 0,5	13,0	38	10	12,93	121401032	27,16									
MF 13 x 1,0	13,0	38	10	12,88	121401033	21,79									

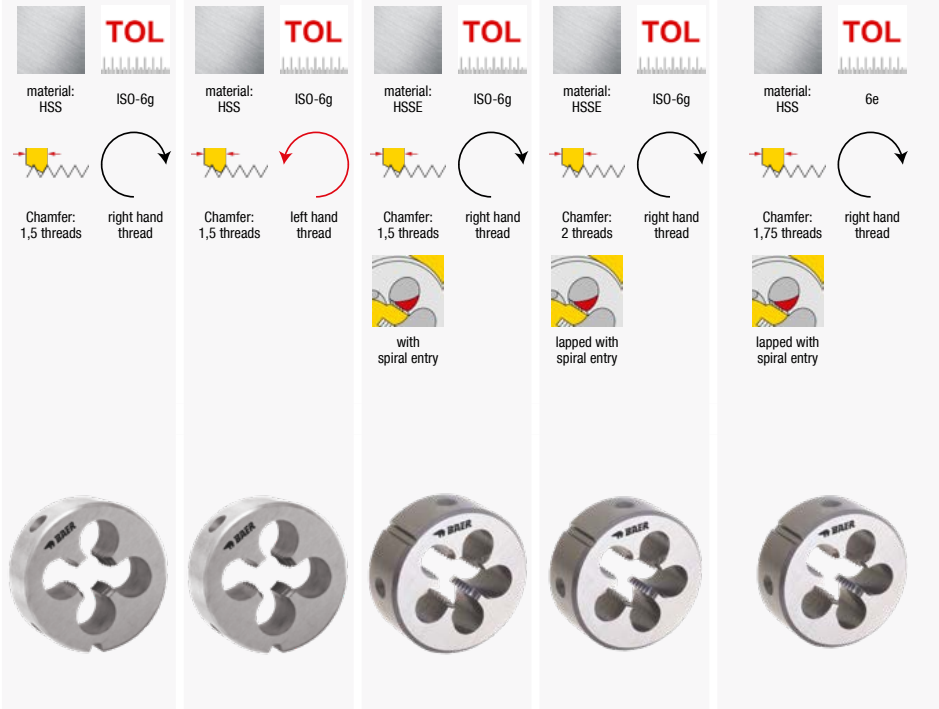
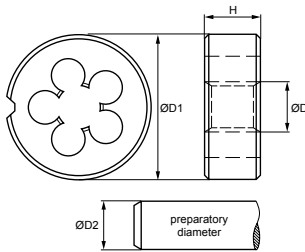
Round Dies for general use
Round Dies for general use Left Hand
Round Dies for higher demands
Round Dies for stainless steels
Round Dies undersized

MF

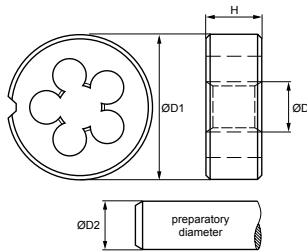
	D	D1	H	D2	No.	€	No.	€	No.	€	No.	€	No.	€	D2	Tol. 6e
MF 13 x 1,5	13,0	38	10	12,85	121401034	21,79										
MF 14 x 0,5	14,0	38	10	13,93	121401035	27,16										
MF 14 x 0,75	14,0	38	10	13,90	121401036	21,79										
MF 14 x 1,0	14,0	38	10	13,88	121401037	21,79					121405017	46,81	121421014	101,87	13,76 mm	
MF 14 x 1,25	14,0	38	10	13,86	121401038	18,21	121402009	31,93	121404009	39,04	121405018	46,81				
MF 14 x 1,5	14,0	38	10	13,85	121401039	18,21	121402010	31,93	121404010	39,04	121405019	46,81	121421015	87,84	13,73 mm	
MF 15 x 0,75	15,0	38	10	14,90	121401040	34,32										
MF 15 x 1,0	15,0	38	10	14,88	121401041	29,58										
MF 15 x 1,5	15,0	38	10	14,85	121401042	29,58										
MF 16 x 0,5	16,0	45	14	15,93	121401043	37,89										
MF 16 x 0,75	16,0	45	14	15,90	121401044	37,89										
MF 16 x 1,0	16,0	45	14	15,88	121401045	29,58	121402011	47,94			121405020	68,32	121421016	136,94	15,76 mm	
MF 16 x 1,25	16,0	45	14	15,86	121401046	29,58										
MF 16 x 1,5	16,0	45	14	15,85	121401047	23,26	121402012	47,94	121404011	61,71	121405021	68,32	121421017	118,90	15,73 mm	
MF 17 x 1,0	17,0	45	14	16,88	121401048	40,21										
MF 17 x 1,5	17,0	45	14	16,85	121401049	40,21										
MF 18 x 0,5	18,0	45	14	17,93	121401050	40,21										
MF 18 x 0,75	18,0	45	14	17,90	121401051	40,21										
MF 18 x 1,0	18,0	45	14	17,88	121401052	27,16					121405022	68,85	121421018	203,74	17,74 mm	
MF 18 x 1,25	18,0	45	14	17,86	121401053	27,16										
MF 18 x 1,5	18,0	45	14	17,85	121401054	23,26	121402013	47,94	121404012	61,71	121405023	68,85	121421019	118,90	17,71 mm	
MF 18 x 2,0	18,0	45	14	17,82	121401055	27,79			121404013	61,71						
MF 19 x 1,0	19,0	45	14	18,88	121401056	40,21										
MF 19 x 1,5	19,0	45	14	18,85	121401057	27,16										
MF 20 x 0,5	20,0	45	14	19,93	121401058	40,21										
MF 20 x 0,75	20,0	45	14	19,90	121401059	40,21										
MF 20 x 1,0	20,0	45	14	19,88	121401060	27,79					121405024	70,52	121421020	203,74	19,66 mm	
MF 20 x 1,25	20,0	45	14	19,86	121401061	27,79										
MF 20 x 1,5	20,0	45	14	19,85	121401062	23,26	121402014	47,94	121404014	61,71	121405025	70,52	121421021	136,94	19,71 mm	
MF 20 x 2,0	20,0	45	14	19,82	121401063	27,79			121404015	61,71						
MF 21 x 1,0	21,0	45	14	20,88	121401064	42,00										
MF 21 x 1,5	21,0	45	14	20,85	121401065	42,00										
MF 22 x 0,5	22,0	55	16	21,93	121401066	58,00										

Round Dies for general use
Round Dies for general use Left Hand
Round Dies for higher demands
Round Dies for stainless steels
Round Dies undersized

Material	TOL	Chamfer	Thread	Special Features
HSS	ISO-6g	1,5 threads	right hand thread	
HSS	ISO-6g	1,5 threads	left hand thread	
HSSE	ISO-6g	1,5 threads	right hand thread	with spiral entry
HSSE	ISO-6g	2 threads	right hand thread	lapped with spiral entry
HSS	6e	1,75 threads	right hand thread	lapped with spiral entry

MF

MF	D	D1	H	D2	No.	€	No.	€	No.	€	No.	€	No.	€	D2 Tol. 6e
MF 22 x 0,75	22,0	55	16	21,90	121401067	58,00									
MF 22 x 1,0	22,0	55	16	21,88	121401068	44,95									
MF 22 x 1,25	22,0	55	16	21,86	121401069	44,95									
MF 22 x 1,5	22,0	55	16	21,85	121401070	40,53	121402015	76,02	121404016	108,31	121405026	104,74	121421022	170,34	21,71 mm
MF 22 x 2,0	22,0	55	16	21,82	121401071	44,95									
MF 23 x 1,0	23,0	55	16	22,88	121401072	58,95									
MF 23 x 1,5	23,0	55	16	22,85	121401073	44,95									
MF 24 x 0,5	24,0	55	16	23,93	121401074	58,00									
MF 24 x 0,75	24,0	55	16	23,90	121401075	58,00									
MF 24 x 1,0	24,0	55	16	23,88	121401076	44,95							121421023	283,91	21,74 mm
MF 24 x 1,25	24,0	55	16	23,86	121401077	44,95									
MF 24 x 1,5	24,0	55	16	23,85	121401078	40,53	121402016	76,02	121404017	108,31	121405027	115,76	121421024	220,45	23,70 mm
MF 24 x 2,0	24,0	55	16	22,82	121401079	44,95	121402017	76,02			121405028	115,76			
MF 25 x 1,0	25,0	55	16	24,88	121401080	58,00									
MF 25 x 1,5	25,0	55	16	24,85	121401081	58,00									
MF 26 x 1,0	26,0	55	16	25,88	121401082	58,00									
MF 26 x 1,5	26,0	55	16	25,85	121401083	58,00					121405029	195,30	121421025	250,50	25,69 mm
MF 26 x 2,0	26,0	55	16	25,82	121401084	58,00									
MF 27 x 1,0	27,0	65	18	26,88	121401085	66,32									
MF 27 x 1,5	27,0	65	18	26,85	121401086	66,32									
MF 27 x 2,0	27,0	65	18	26,82	121401087	66,32									
MF 28 x 1,0	28,0	65	18	27,88	121401088	66,32									
MF 28 x 1,5	28,0	65	18	27,85	121401089	66,32									
MF 28 x 2,0	28,0	65	18	27,82	121401090	66,32									
MF 29 x 1,5	29,0	65	18	28,85	121401091	66,32									
MF 30 x 1,0	30,0	65	18	29,88	121401092	66,32									
MF 30 x 1,5	30,0	65	18	29,85	121401093	66,32					121405030	215,15			
MF 30 x 2,0	30,0	65	18	29,82	121401094	66,32	121402018	120,46			121405031	225,45			
MF 30 x 2,5	30,0	65	18	29,79	121401095	66,32	121402019	120,46							
MF 30 x 3,0	30,0	65	25	29,76	121401096	66,32	121402020	120,46							
MF 32 x 1,0	32,0	65	18	31,88	121401098	93,68	121402021	120,46							
MF 32 x 1,5	32,0	65	18	31,85	121401097	66,32	121402022	120,46							
MF 32 x 2,0	32,0	65	18	31,82	121401099	66,32	121402023	120,46							

Round Dies for general use

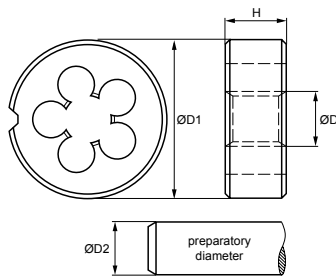
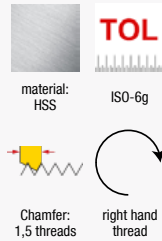

Round Dies for general use

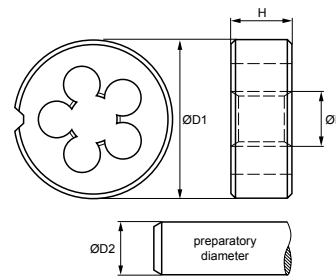
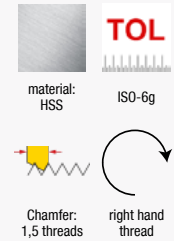

MF	D	D1	H	D2	No.	€
MF 32 x 3,0	32,0	65	25	31,77	121401100	66,32
MF 33 x 1,5	33,0	65	18	32,85	121401101	66,32
MF 33 x 2,0	33,0	65	18	32,82	121401102	66,32
MF 33 x 3,0	33,0	65	25	32,76	121401103	66,32
MF 34 x 1,0	34,0	65	18	33,88	121401104	93,68
MF 34 x 1,5	34,0	65	18	33,85	121401105	66,32
MF 34 x 2,0	34,0	65	18	33,82	121401106	66,32
MF 35 x 1,0	35,0	65	18	34,88	121401107	93,68
MF 35 x 1,5	35,0	65	18	34,85	121401108	66,32
MF 35 x 2,0	35,0	65	18	34,82	121401109	93,68
MF 36 x 1,0	36,0	65	18	35,88	121401110	93,68
MF 36 x 1,5	36,0	65	18	35,85	121401111	66,32
MF 36 x 2,0	36,0	65	18	35,82	121401112	66,32
MF 36 x 3,0	36,0	65	25	35,76	121401113	66,32
MF 37 x 1,5	37,0	65	18	36,85	121401114	141,05
MF 38 x 1,0	38,0	75	20	37,88	121401115	141,05
MF 38 x 1,5	38,0	75	20	37,85	121401116	107,37
MF 38 x 2,0	38,0	75	20	37,82	121401117	107,37
MF 38 x 3,0	38,0	75	30	37,77	121401118	141,05
MF 39 x 1,5	39,0	75	20	38,85	121401119	107,37
MF 39 x 2,0	39,0	75	20	38,82	121401120	107,37
MF 39 x 3,0	39,0	75	30	38,76	121401121	107,37
MF 40 x 1,0	40,0	75	20	39,88	121401122	141,05
MF 40 x 1,5	40,0	75	20	39,85	121401123	107,37
MF 40 x 2,0	40,0	75	20	39,82	121401124	107,37
MF 40 x 3,0	40,0	75	30	39,76	121401125	107,37
MF 42 x 1,0	42,0	75	20	41,88	121401126	141,05
MF 42 x 1,5	42,0	75	20	41,85	121401127	107,37
MF 42 x 2,0	42,0	75	20	41,82	121401128	107,37
MF 42 x 3,0	42,0	75	30	41,76	121401129	107,37
MF 44 x 1,5	44,0	90	22	43,85	121401130	231,58
MF 44 x 2,0	44,0	90	22	43,82	121401131	231,58
MF 45 x 1,0	45,0	90	22	44,88	121401132	231,58

MF	D	D1	H	D2	No.	€
MF 45 x 1,5	45,0	90	22	44,85	121401133	178,95
MF 45 x 2,0	45,0	90	22	44,82	121401134	178,95
MF 45 x 3,0	45,0	90	36	44,76	121401135	178,95
MF 46 x 1,5	46,0	90	22	45,85	121401136	231,58
MF 48 x 1,0	48,0	90	22	47,88	121401137	231,58
MF 48 x 1,5	48,0	90	22	47,85	121401138	178,95
MF 48 x 2,0	48,0	90	22	47,82	121401139	178,95
MF 48 x 3,0	48,0	90	36	47,46	121401140	178,95
MF 50 x 1,5	50,0	90	22	49,85	121401141	178,95
MF 50 x 2,0	50,0	90	22	49,82	121401142	178,95
MF 50 x 3,0	50,0	90	36	49,76	121401143	178,95
MF 52 x 1,5	52,0	90	22	51,85	121401144	178,95
MF 52 x 2,0	52,0	90	22	51,82	121401145	178,95
MF 52 x 3,0	52,0	90	36	51,76	121401146	178,95
MF 54 x 1,5	54,0	105	22	53,92	121401147	353,68
MF 54 x 2,0	54,0	105	22	53,91	121401148	353,68
MF 54 x 3,0	54,0	105	36	53,88	121401149	353,68
MF 54 x 4,0	54,0	105	36	53,85	121401150	353,68
MF 55 x 1,5	55,0	105	22	54,85	121401151	353,68
MF 55 x 2,0	55,0	105	22	54,82	121401152	353,68
MF 55 x 3,0	55,0	105	36	54,76	121401153	353,68
MF 55 x 4,0	55,0	105	36	54,73	121401154	353,68
MF 56 x 1,5	56,0	105	22	55,85	121401155	353,68
MF 56 x 2,0	56,0	105	22	55,82	121401156	353,68
MF 56 x 3,0	56,0	105	36	55,76	121401157	353,68
MF 56 x 4,0	56,0	105	36	55,73	121401158	353,68
MF 58 x 1,5	58,0	105	22	57,92	121401159	353,68
MF 58 x 2,0	58,0	105	22	57,91	121401160	353,68
MF 58 x 3,0	58,0	105	36	57,88	121401161	353,68
MF 58 x 4,0	58,0	105	36	57,85	121401162	353,68
MF 60 x 1,5	60,0	105	22	59,92	121401163	353,68
MF 60 x 2,0	60,0	105	22	59,91	121401164	353,68
MF 60 x 3,0	60,0	105	36	59,88	121401165	353,68

Round Dies for general use

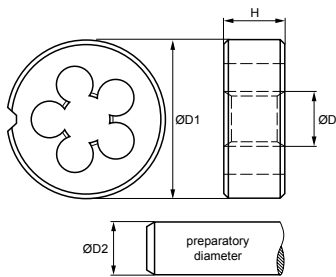
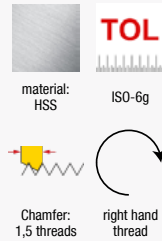

Round Dies for general use

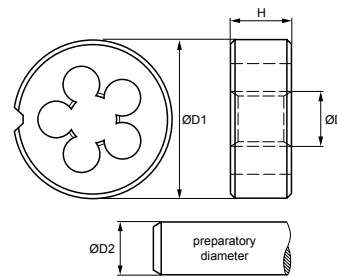
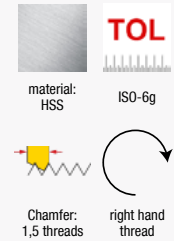

MF

	D	D1	H	D2	No.	€
MF 60 x 4,0	60,0	105	36	59,85	121401166	353,68
MF 62 x 1,5	62,0	105	22	61,92	121401167	353,68
MF 62 x 2,0	62,0	105	22	61,91	121401168	353,68
MF 62 x 3,0	62,0	105	36	61,88	121401169	353,68
MF 62 x 4,0	62,0	105	36	61,85	121401170	353,68
MF 63 x 1,5	63,0	105	22	62,92	121401171	353,68
MF 64 x 1,5	64,0	120	22	63,92	121401172	402,11
MF 64 x 2,0	64,0	120	22	63,91	121401173	402,11
MF 64 x 3,0	64,0	120	36	63,88	121401174	402,11
MF 64 x 4,0	64,0	120	36	63,85	121401175	402,11
MF 65 x 1,5	65,0	120	22	64,92	121401176	402,11
MF 65 x 2,0	65,0	120	22	64,91	121401177	402,11
MF 65 x 3,0	65,0	120	36	64,88	121401178	402,11
MF 65 x 4,0	65,0	120	36	64,85	121401179	402,11
MF 68 x 1,5	68,0	120	22	67,92	121401180	402,11
MF 68 x 2,0	68,0	120	22	67,91	121401181	402,11
MF 68 x 3,0	68,0	120	36	67,88	121401182	402,11
MF 68 x 4,0	68,0	120	36	67,85	121401183	402,11
MF 70 x 1,5	70,0	120	22	69,92	121401184	402,11
MF 70 x 2,0	70,0	120	22	69,91	121401185	402,11
MF 70 x 3,0	70,0	120	36	69,88	121401186	402,11
MF 70 x 4,0	70,0	120	36	69,85	121401187	402,11
MF 72 x 1,5	72,0	120	22	71,92	121401188	402,11
MF 72 x 2,0	72,0	120	22	71,91	121401189	402,11
MF 72 x 3,0	72,0	120	36	71,88	121401190	402,11
MF 72 x 4,0	72,0	120	36	71,85	121401191	402,11
MF 74 x 1,5	74,0	120	22	73,92	121401192	402,11
MF 74 x 2,0	74,0	120	22	73,91	121401193	402,11
MF 74 x 3,0	74,0	120	36	73,88	121401194	402,11
MF 74 x 4,0	74,0	120	36	73,85	121401195	402,11
MF 75 x 1,5	75,0	120	22	74,92	121401196	402,11
MF 75 x 2,0	75,0	120	22	74,91	121401197	402,11
MF 75 x 3,0	75,0	120	36	74,88	121401198	402,11

MF

	D	D1	H	D2	No.	€
MF 75 x 4,0	75,0	120	36	74,85	121401199	402,11
MF 76 x 1,5	76,0	120	22	75,92	121401200	402,11
MF 76 x 2,0	76,0	120	22	75,91	121401201	402,11
MF 76 x 3,0	76,0	120	36	75,88	121401202	402,11
MF 76 x 4,0	76,0	120	36	75,85	121401203	402,11
MF 78 x 1,5	78,0	120	22	77,92	121401204	402,11
MF 78 x 2,0	78,0	120	22	77,91	121401205	402,11
MF 78 x 3,0	78,0	120	36	77,88	121401206	402,11
MF 78 x 4,0	78,0	120	36	77,85	121401207	402,11
MF 80 x 1,5	80,0	120	22	79,92	121401208	402,11
MF 80 x 2,0	80,0	120	22	79,91	121401209	402,11
MF 80 x 3,0	80,0	120	36	79,88	121401210	402,11
MF 80 x 4,0	80,0	120	36	79,85	121401211	402,11
MF 82 x 1,5	82,0	130	25	81,92	121401212	508,42
MF 82 x 2,0	82,0	130	25	81,91	121401213	508,42
MF 82 x 3,0	82,0	130	36	81,88	121401214	508,42
MF 82 x 4,0	82,0	130	36	81,85	121401215	508,42
MF 84 x 1,5	84,0	130	25	83,92	121401216	508,42
MF 84 x 2,0	84,0	130	25	83,91	121401217	508,42
MF 84 x 3,0	84,0	130	36	83,88	121401218	508,42
MF 84 x 4,0	84,0	130	36	83,85	121401219	508,42
MF 85 x 1,5	85,0	130	25	84,92	121401220	508,42
MF 85 x 2,0	85,0	130	25	84,91	121401221	508,42
MF 85 x 3,0	85,0	130	36	84,88	121401222	508,42
MF 85 x 4,0	85,0	130	36	84,85	121401223	508,42
MF 86 x 1,5	86,0	140	22	85,92	121401224	633,68
MF 86 x 2,0	86,0	140	22	85,91	121401225	633,68
MF 86 x 3,0	86,0	140	22	85,88	121401226	633,68
MF 86 x 4,0	86,0	140	22	85,85	121401227	633,68
MF 88 x 1,5	88,0	140	22	87,92	121401228	633,68
MF 88 x 2,0	88,0	140	22	87,91	121401229	633,68
MF 88 x 3,0	88,0	140	22	87,88	121401230	633,68
MF 88 x 4,0	88,0	140	22	87,85	121401231	633,68

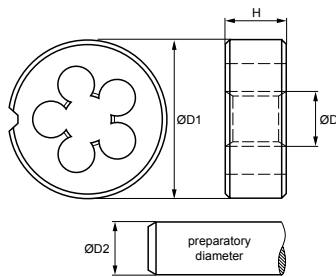
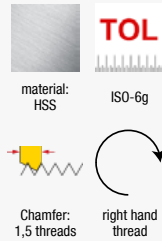
Round Dies for general use



MF

	D	D1	H	D2	No.	€
MF 90 x 1,5	90,0	140	22	89,92	121401232	633,68
MF 90 x 2,0	90,0	140	22	89,91	121401233	633,68
MF 90 x 3,0	90,0	140	22	89,88	121401234	633,68
MF 90 x 4,0	90,0	140	22	89,85	121401235	633,68
MF 92 x 1,5	92,0	140	22	91,92	121401236	633,68
MF 92 x 2,0	92,0	140	22	91,91	121401237	633,68
MF 92 x 3,0	92,0	140	22	91,88	121401238	633,68
MF 92 x 4,0	92,0	140	22	91,85	121401239	633,68
MF 95 x 1,5	95,0	140	22	94,92	121401240	633,68
MF 95 x 2,0	95,0	140	22	94,91	121401241	633,68
MF 95 x 3,0	95,0	140	22	94,88	121401242	633,68
MF 95 x 4,0	95,0	140	22	94,85	121401243	633,68
MF 96 x 1,5	96,0	140	22	95,92	121401244	633,68
MF 96 x 2,0	96,0	140	22	95,91	121401245	633,68
MF 96 x 3,0	96,0	140	22	95,88	121401246	633,68
MF 96 x 4,0	96,0	140	22	95,85	121401247	633,68
MF 98 x 1,5	98,0	150	25	94,92	121401248	762,11
MF 98 x 2,0	98,0	150	25	97,91	121401249	762,11
MF 98 x 3,0	98,0	150	25	97,88	121401250	762,11
MF 98 x 4,0	98,0	150	25	97,85	121401251	762,11
MF 100 x 1,5	100,0	150	25	99,92	121401252	762,11
MF 100 x 2,0	100,0	150	25	99,91	121401253	762,11
MF 100 x 3,0	100,0	150	25	99,88	121401254	762,11
MF 100 x 4,0	100,0	150	25	99,85	121401255	762,11
MF 105 x 1,5	105,0	150	25	104,92	121401256	762,11
MF 105 x 2,0	105,0	150	25	104,91	121401257	762,11
MF 105 x 3,0	105,0	150	25	104,88	121401258	762,11
MF 105 x 4,0	105,0	150	25	104,85	121401259	762,11
MF 110 x 1,5	110,0	160	25	109,92	121401260	832,63
MF 110 x 2,0	110,0	160	25	109,91	121401261	832,63
MF 110 x 3,0	110,0	160	25	109,88	121401262	832,63
MF 110 x 4,0	110,0	160	25	109,85	121401263	832,63

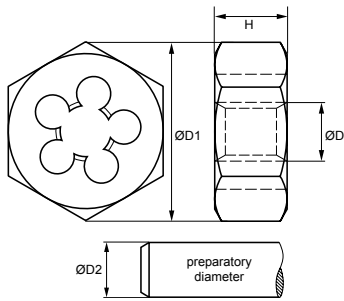
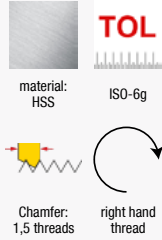
Hexagon Di Nuts for general use

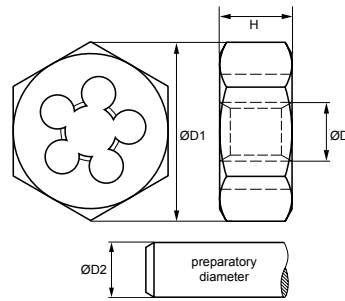
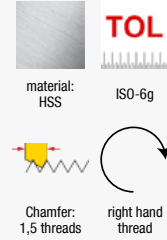

Hexagon Di Nuts for general use



MF

	D	D1	H	D2	No.	€
MF 3 x 0,35	3,0	19	5	2,94	121501001	22,00
MF 4 x 0,35	3,5	19	5	3,44	121501002	22,00
MF 4 x 0,5	4,0	19	5	3,93	121501003	22,00
MF 5 x 0,5	5,0	19	5	4,93	121501004	22,00
MF 5 x 0,75	5,0	19	7	4,91	121501005	22,00
MF 6 x 0,5	6,0	19	5	5,93	121501006	22,00
MF 6 x 0,75	6,0	19	7	5,90	121501007	22,00
MF 7 x 0,75	7,0	22	9	6,90	121501008	23,68
MF 8 x 0,5	8,0	22	9	7,93	121501009	23,68
MF 8 x 0,75	8,0	22	9	7,90	121501010	23,68
MF 8 x 1,0	8,0	22	9	7,83	121501011	23,68
MF 9 x 0,75	9,0	22	9	8,90	121501012	23,68
MF 9 x 1,0	9,0	22	9	8,88	121501013	23,68
MF 10 x 0,75	10,0	27	11	9,90	121501014	23,68
MF 10 x 1,0	10,0	27	11	9,88	121501015	23,68
MF 10 x 1,25	10,0	27	11	9,86	121501016	23,68
MF 11 x 1,0	11,0	27	11	10,88	121501017	33,16
MF 11 x 1,25	11,0	27	11	10,86	121501018	33,16
MF 12 x 0,75	12,0	36	10	11,90	121501019	33,16
MF 12 x 1,0	12,0	36	10	11,88	121501020	33,16
MF 12 x 1,25	12,0	36	10	11,86	121501021	33,16
MF 12 x 1,5	12,0	36	10	11,85	121501022	33,16
MF 13 x 1,0	13,0	36	10	12,88	121501023	37,68
MF 13 x 1,5	13,0	36	10	12,85	121501024	37,68
MF 14 x 0,75	14,0	36	10	13,90	121501025	37,68
MF 14 x 1,0	14,0	36	10	13,88	121501026	37,68
MF 14 x 1,25	14,0	36	10	13,86	121501027	37,68
MF 14 x 1,5	14,0	36	10	13,85	121501028	37,68
MF 15 x 1,0	15,0	36	10	14,88	121501029	43,89
MF 15 x 1,5	15,0	36	10	14,85	121501030	43,89
MF 16 x 1,0	16,0	41	14	15,88	121501031	46,21
MF 16 x 1,25	16,0	41	14	15,86	121501032	46,21
MF 16 x 1,5	16,0	41	14	15,85	121501033	46,21
MF 18 x 1,0	18,0	41	14	17,88	121501034	48,42

MF

	D	D1	H	D2	No.	€
MF 18 x 1,25	18,0	41	14	17,86	121501035	48,42
MF 18 x 1,5	18,0	41	14	17,85	121501036	48,42
MF 18 x 2,0	18,0	41	14	17,82	121501037	48,42
MF 20 x 1,0	20,0	41	14	19,88	121501038	48,42
MF 20 x 1,25	20,0	41	14	19,86	121501039	48,42
MF 20 x 1,5	20,0	41	14	19,85	121501040	48,42
MF 20 x 2,0	20,0	41	14	19,82	121501041	48,42
MF 21 x 1,5	21,0	41	14	20,85	121501042	70,95
MF 22 x 1,0	22,0	50	16	21,88	121501043	70,95
MF 22 x 1,25	22,0	50	16	21,86	121501044	70,95
MF 22 x 1,5	22,0	50	16	21,85	121501045	70,95
MF 22 x 2,0	22,0	50	16	21,82	121501046	70,95
MF 23 x 1,5	23,0	50	16	22,85	121501047	70,95
MF 24 x 1,0	24,0	50	16	23,88	121501048	70,95
MF 24 x 1,25	24,0	50	16	23,86	121501049	70,95
MF 24 x 1,5	24,0	50	16	23,85	121501050	70,95
MF 24 x 2,0	24,0	50	16	22,82	121501051	70,95
MF 25 x 1,0	25,0	50	16	24,88	121501052	102,53
MF 25 x 1,5	25,0	50	16	24,85	121501053	102,53
MF 26 x 1,0	26,0	50	16	25,88	121501054	102,53
MF 26 x 1,5	26,0	50	16	25,85	121501055	102,53
MF 26 x 2,0	26,0	50	16	25,82	121501056	102,53
MF 27 x 1,0	27,0	60	18	26,88	121501057	107,37
MF 27 x 1,5	27,0	60	18	26,85	121501058	107,37
MF 27 x 2,0	27,0	60	18	26,82	121501059	107,37
MF 28 x 1,0	28,0	60	18	27,88	121501060	107,37
MF 28 x 1,5	28,0	60	18	27,85	121501061	107,37
MF 28 x 2,0	28,0	60	18	27,82	121501062	107,37
MF 29 x 1,5	29,0	60	18	28,85	121501063	107,37
MF 30 x 1,0	30,0	60	18	29,88	121501064	107,37
MF 30 x 1,5	30,0	60	18	29,85	121501065	107,37
MF 30 x 2,0	30,0	60	18	29,82	121501066	107,37
MF 30 x 3,0	30,0	60	25	29,76	121501067	107,37
MF 32 x 1,5	32,0	60	18	31,85	121501068	107,37

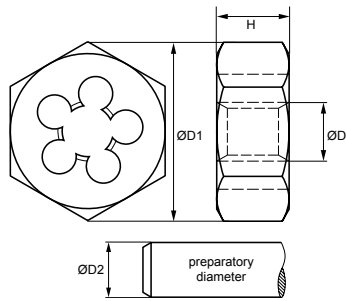
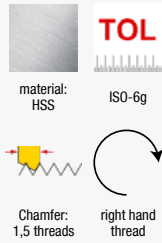
Hexagon Di Nuts for general use



MF	D	D1	H	D2	No.	€
MF 32 x 2,0	32,0	60	18	31,82	121501069	107,37
MF 32 x 3,0	32,0	60	25	31,77	121501070	107,37
MF 33 x 1,5	33,0	60	18	32,85	121501071	107,37
MF 33 x 2,0	33,0	60	18	32,82	121501072	107,37
MF 33 x 3,0	33,0	60	25	32,76	121501073	107,37
MF 34 x 1,5	34,0	60	18	33,85	121501074	107,37
MF 34 x 2,0	34,0	60	18	33,82	121501075	107,37
MF 35 x 1,5	35,0	60	18	34,85	121501076	107,37
MF 36 x 1,5	36,0	60	18	35,85	121501077	107,37
MF 36 x 2,0	36,0	60	18	35,82	121501078	107,37
MF 36 x 3,0	36,0	60	25	35,76	121501079	107,37
MF 38 x 1,5	38,0	70	20	37,85	121501080	178,95
MF 39 x 1,5	39,0	70	20	38,85	121501081	178,95
MF 39 x 2,0	39,0	70	20	38,82	121501082	178,95
MF 39 x 3,0	39,0	70	30	38,76	121501083	178,95
MF 40 x 1,5	40,0	70	20	39,85	121501084	178,95
MF 40 x 2,0	40,0	70	20	39,82	121501085	178,95
MF 40 x 3,0	40,0	70	30	39,76	121501086	178,95
MF 42 x 1,5	42,0	70	20	41,85	121501087	178,95
MF 42 x 2,0	42,0	70	20	41,82	121501088	178,95
MF 42 x 3,0	42,0	70	30	41,76	121501089	178,95
MF 45 x 1,5	45,0	85	22	44,85	121501090	263,16
MF 45 x 2,0	45,0	85	22	44,82	121501091	263,16
MF 45 x 3,0	45,0	85	36	44,76	121501092	263,16
MF 48 x 1,5	48,0	85	22	47,85	121501093	263,16
MF 48 x 2,0	48,0	85	22	47,82	121501094	263,16
MF 48 x 3,0	48,0	85	36	47,46	121501095	263,16
MF 50 x 1,5	50,0	85	22	49,85	121501096	263,16
MF 50 x 2,0	50,0	85	22	49,82	121501097	263,16
MF 50 x 3,0	50,0	85	36	49,76	121501098	263,16
MF 52 x 1,5	52,0	85	22	51,85	121501099	263,16
MF 52 x 2,0	52,0	85	22	51,82	121501100	263,16
MF 52 x 3,0	52,0	85	36	51,76	121501101	263,16

G-Rohr (BSP)

British standard whitworth pipe thread / DIN ISO 228

BAER Hand-Tap Sets, Round Dies and Tools Sets (example picture)



BAER Set G(BSP) 1/8" - 1"

HSSG Hand Tap Sets & HSS Round Dies & Tools

BAER HSSG Hand Tap Sets (2 parts)	G 1/8 x 28 G 1/4 x 19 G 3/8 x 19 G 1/2 x 14 G 3/4 x 14 G 1" x 11
BAER HSS Round Dies	G 1/8 x 28 G 1/4 x 19 G 3/8 x 19 G 1/2 x 14 G 3/4 x 14 G 1" x 11
BAER adjustable Tap Wrenches - zinc die cast	M 1-10 1/16-3/8 G 1/8 & M 5-20 7/32-3/4" G 1/8-1/2 & M 13-32 1/2-1.1/4" G 1/4-1"
BAER Die Stocks - zinc die cast	30 x 11 38 x 10 45 x 14 55 x 16 68 x 18
Screw extractor	

656,70
€/Set

Item No.:
264802014

BAER Set G(BSP) 1/8" - 1" (incl. intermediate sizes)

HSSG Hand Tap Sets & HSS Round Dies & Tools

BAER HSSG Hand Tap Sets (2 parts)	G 1/8 x 28 G 1/4 x 19 G 3/8 x 19 G 1/2 x 14 G 5/8 x 14 G 3/4 x 14 G 7/8 x 14 G 1" x 11
BAER HSS Round Dies	G 1/8 x 28 G 1/4 x 19 G 3/8 x 19 G 1/2 x 14 G 5/8 x 14 G 3/4 x 14 G 7/8 x 14 G 1" x 11
BAER adjustable Tap Wrenches - zinc die cast	M 1-10 1/16-3/8 G 1/8 & M 5-20 7/32-3/4" G 1/8-1/2 & M 13-32 1/2-1.1/4" G 1/4-1"
BAER Die Stocks - zinc die cast	30 x 11 38 x 10 45 x 14 55 x 16 68 x 18
Screw extractor	

875,60
€/Set

Item No.:
264802114

BAER Set G(BSP) 1/4" - 1.1/2"

HSSG Hand Tap Sets & HSS Round Dies & Tools

BAER HSSG Hand Tap Sets (2 parts)	G 1/4 x 19 G 3/8 x 19 G 1/2 x 14 G 3/4 x 14 G 1" x 11 G 1.1/4" x 11 G 1.1/2" x 11
BAER HSS Round Dies	G 1/4 x 19 G 3/8 x 19 G 1/2 x 14 G 3/4 x 14 G 1" x 11 G 1.1/4" x 11 G 1.1/2" x 11
BAER adjustable Tap Wrenches - zinc die cast	M 4-12 5/32-1/2 G 1/8 & M 11-27 7/16-1" G 1/4-3/4 & M 27-52 1.1/8"-2" G 3/4-1.3/4"
BAER Die Stocks - zinc die cast	38 x 10 45 x 14 55 x 16 68 x 18 75 x 20 90 x 22
Screw extractor	

1.869,55
€/Set

Item No.:
264802214

G-Rohr (BSP)

British standard whitworth pipe thread / DIN ISO 228

BAER Hand-Tap Sets, Round Dies and Tools Sets (example picture)



BAER Set G(BSP) 1/8" - 3/4" Short Machine Taps through hole & blind hole HSS Hexagonal-Die-Nuts



203,07
€/Set

BAER HSSG Short Machine TapsForm D for through holes and blind holes (up to 4 x D)	G 1/8 x 28 G 1/4 x 19 G 3/8 x 19 G 1/2 x 14 G 3/4 x 14
BAER HSS Hexagonal-Die-Nuts	G 1/8 x 28 G 1/4 x 19 G 3/8 x 19 G 1/2 x 14 G 3/4 x 14

Item No.:
BSR1

BAER Set G(BSP) 1/8" - 1/2" Short Machine Taps through hole & blind hole HSS Hexagonal-Die-Nuts



139,64
€/Set

BAER HSSG Short Machine TapsForm D for through holes and blind holes (up to 4 x D)	G 1/8 x 28 G 1/4 x 19 G 3/8 x 19 G 1/2 x 14
BAER HSS Hexagonal-Die-Nuts	G 1/8 x 28 G 1/4 x 19 G 3/8 x 19 G 1/2 x 14

Item No.:
BSR2

BAER Set G(BSP) 1/8" - 3/4" Short Machine Taps through hole & blind hole HSS Round Dies



209,42
€/Set

BAER HSSG Short Machine TapsForm D for through holes and blind holes (up to 4 x D)	G 1/8 x 28 G 1/4 x 19 G 3/8 x 19 G 1/2 x 14 G 3/4 x 14
BAER HSS Round Dies	G 1/8 x 28 G 1/4 x 19 G 3/8 x 19 G 1/2 x 14 G 3/4 x 14

Item No.:
BSR3

G-Rohr (BSP)

British standard whitworth pipe thread / DIN ISO 228

Efficient internal thread cutting.

The short structural type makes that tap usable by machine and hand.

Application:

- non abrasive material up to 900 N/mm²
- unalloyed and low alloyed steel

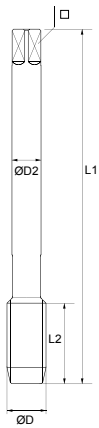

Short Machine Taps Form D for through holes and blind holes

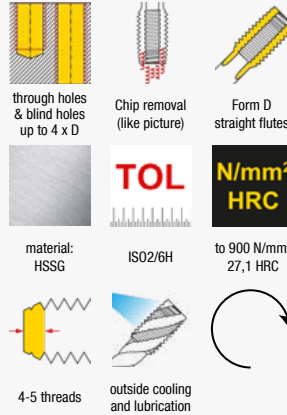

G(BSP)

	D1	D2	L1	L2	□		No.	€
BSP 1/8 x 28	9,73	7,0	63	20	5,5	8,80	130101001	6,39
BSP 1/4 x 19	13,16	11,0	70	22	9,0	11,80	130101002	7,20
BSP 3/8 x 19	16,66	12,0	70	22	9,0	15,25	130101003	10,48
BSP 1/2 x 14	20,95	16,0	80	22	12,0	19,00	130101004	14,89
BSP 3/4 x 14	26,44	20,0	90	22	16,0	24,50	130101005	21,05
BSP 1" x 11	33,25	25,0	100	25	20,0	30,75	130101006	35,49
BSP 1.1/4 x 11	41,91	32,0	125	40	24,0	39,50	130101007	61,67
BSP 1.1/2 x 11	47,80	36,0	140	40	29,0	45,25	130101008	84,36
BSP 1.3/4 x 11	53,74	40,0	140	40	32,0	51,20	130101009	168,70
BSP 2" x 11	59,61	45,0	160	40	35,0	57,00	130101010	174,53
BSP 2.1/4 x 11	65,71	50,0	160	40	39,0	63,10	130101011	381,64
BSP 2.1/2 x 11	75,18	50,0	160	40	39,0	72,60	130101012	579,31
BSP 2.3/4 x 11	81,53	50,0	160	40	39,0	79,00	130101013	967,19
BSP 3" x 11	87,88	50,0	160	40	39,0	85,50	130101014	1.127,13
BSP 3.1/2 x 11	100,3	56,0	180	45	44,0	98,00	130101015	1.775,71
BSP 4" x 11	113,0	56,0	180	45	44,0	110,50	130101016	2.216,49

G-Rohr (BSP)

British standard whitworth pipe thread / DIN ISO 228

Efficient internal thread cutting.

The short structural type makes that tap usable by machine and hand.

A Hand-Tap-Set includes 2 taps:

- Taper Tap
- Finish Tap

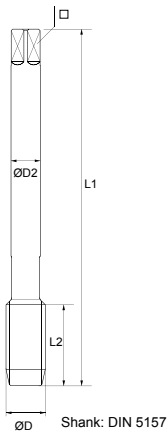

Hand Tap Sets for general use

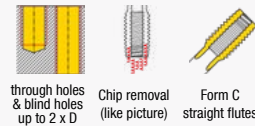

through holes & blind holes up to 2 x D
Chip removal (like picture)
Form C straight flutes

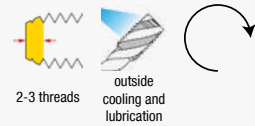

Hand Tap Sets for general use Left Hand

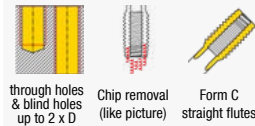

through holes & blind holes up to 2 x D
Chip removal (like picture)
Form C straight flutes

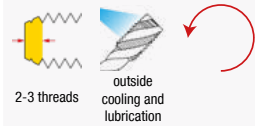

Hand Tap Sets for high tensile materials

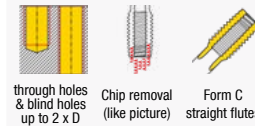

through holes & blind holes up to 2 x D
Chip removal (like picture)
Form C straight flutes

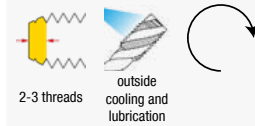

G(BSP)

	D1	D2	L1	L2	□		No.	€	No.	€	No.	€
BSP 1/8 x 28	9,73	7,0	63	20	5,5	8,80	130301001	12,80	130302001	19,55	130304001	18,62
BSP 1/4 x 19	13,16	11,0	70	22	9,0	11,80	130301002	14,43	130302002	22,10	130304002	23,27
BSP 3/8 x 19	16,66	12,0	70	22	9,0	15,25	130301003	20,94	130302003	31,89	130304003	33,04
BSP 1/2 x 14	20,95	16,0	80	22	12,0	19,00	130301004	29,78	130302004	41,42	130304004	51,20
BSP 5/8 x 14	22,91	18,0	80	22	14,5	21,00	130301005	42,13	130302005	63,54		
BSP 3/4 x 14	26,44	20,0	90	22	16,0	24,50	130301006	42,13	130302006	63,54	130304005	62,13
BSP 7/8 x 14	30,20	22,0	90	22	18,0	28,25	130301007	70,98				
BSP 1" x 11	33,25	25,0	100	25	20,0	30,75	130301008	70,98	130302007	107,51	130304006	107,04
BSP 1.1/8 x 11	37,90	28,0	125	40	22,0	35,30	130301009	123,33	130302008	186,17		
BSP 1.1/4 x 11	41,91	32,0	125	40	24,0	39,50	130301010	123,33	130302009	186,17		
BSP 1.3/8 x 11	44,32	36,0	140	40	29,0	41,70	130301011	168,70	130302010	246,67		
BSP 1.1/2 x 11	47,80	36,0	140	40	29,0	45,25	130301012	168,70	130302011	246,67		
BSP 1.5/8 x 11	52,00	40,0	140	40	32,0	49,60	130301013	337,43				
BSP 1.3/4 x 11	53,74	40,0	140	40	32,0	51,20	130301014	337,42	130302012	507,29		
BSP 2" x 11	59,61	45,0	160	40	35,0	57,00	130301015	349,08	130302013	507,29		
BSP 2.1/4 x 11	65,71	50,0	160	40	39,0	63,10	130301016	763,31				
BSP 2.1/2 x 11	75,18	50,0	160	40	39,0	72,60	130301017	1.158,62				
BSP 2.3/4 x 11	81,53	50,0	160	40	39,0	79,00	130301018	1.935,23				
BSP 3" x 11	87,88	50,0	160	40	39,0	85,50	130301019	2.254,27				
BSP 3.1/2 x 11	100,3	56,0	180	45	44,0	98,00	130301020	3.551,42				
BSP 4" x 11	113,0	56,0	180	45	44,0	110,50	130301021	4.432,98				

Machine Taps - Form B for through holes and Form C Left-hand thread

G-Rohr (BSP)

British standard whitworth pipe thread / DIN ISO 228

Tap for machine use in through hole and for left-hand thread in through and blind holes.

The spiral point pushes the chips ahead.

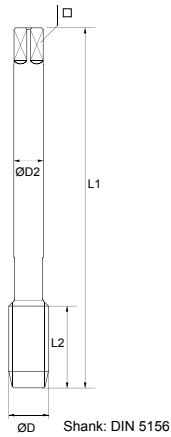

Machine Tap for general use



through holes up to 4 x D
Chip removal (like picture)
Form B with spiral point



material: HSSE
TOL medium
N/mm² HRC to 900 N/mm² 27,1 HRC

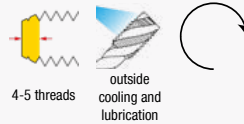

4-5 threads
outside cooling and lubrication



Machine Tap for stainless steels



through holes up to 2,5 x D
Chip removal (like picture)
Form B with spiral point



material: HSSE TiAlN
TOL medium
N/mm² HRC to 1300 N/mm² 41 HRC

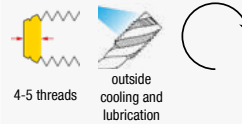

4-5 threads
outside cooling and lubrication



Machine Tap for general use Left-hand thread



through holes & blind holes up to 2 x D
Chip removal (like picture)
Form C straight flutes



material: HSSE
TOL medium
N/mm² HRC to 900 N/mm² 27,1 HRC

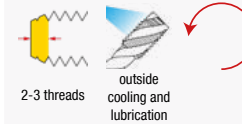

2-3 threads
outside cooling and lubrication



G(BSP)

	D1	D2	L1	L2	□		No.	€	No.	€	No.	€
BSP 1/8 x 28	9,73	7,0	90	20	5,5	8,80	130401001	17,63	130405001	38,58	130502001	25,19
BSP 1/4 x 19	13,16	11,0	100	22	9,0	11,80	130401002	22,25	130405002	56,36	130502002	31,06
BSP 3/8 x 19	16,66	12,0	100	22	9,0	15,25	130401003	26,45	130405003	64,83	130502003	39,04
BSP 1/2 x 14	20,95	16,0	125	25	12,0	19,00	130401004	39,04	130405004	84,29	130502004	54,89
BSP 5/8 x 14	22,91	18,0	125	25	14,5	21,00	130401005	45,34	130405005	95,99	130502005	63,49
BSP 3/4 x 14	26,44	20,0	140	28	16,0	24,50	130401006	57,93	130405006	112,17	130502006	80,60
BSP 7/8 x 14	30,20	22,0	150	28	18,0	28,25	130401007	73,04	130405007	194,64		
BSP 1" x 11	33,25	25,0	160	30	20,0	30,75	130401008	90,67	130405008	240,10	130502007	81,23
BSP 1.1/8 x 11	37,90	28,0	170	30	22,0	35,30	130401009	133,49	130405009	299,71		
BSP 1.1/4 x 11	41,91	32,0	170	30	24,0	39,50	130401010	158,68	130405010	338,34		
BSP 1.3/8 x 11	44,32	36,0	180	32	29,0	41,70	130401011	210,31	130405011	412,16		
BSP 1.1/2 x 11	47,80	36,0	190	32	29,0	45,25	130401012	227,95	130405012	449,65		
BSP 1.3/4 x 11	53,74	40,0	190	32	32,0	51,20	130401013	329,95	130405013	578,52		
BSP 2" x 11	59,61	45,0	220	40	35,0	57,00	130401014	365,22	130405014	602,19		

G-Rohr (BSP)

British standard whitworth pipe thread / DIN ISO 228

Tap for machine use in through hole and for left-hand thread in through and blind holes.

The spiral point pushes the chips ahead.

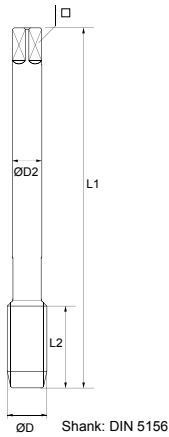

Machine Tap for general use

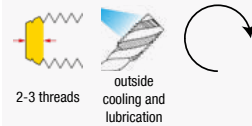
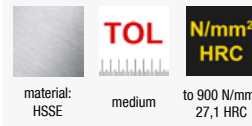
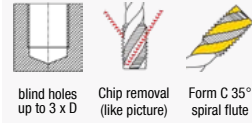

Machine Tap for stainless steels

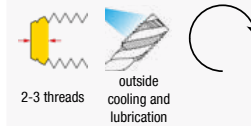
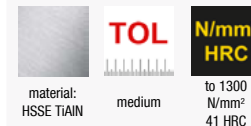
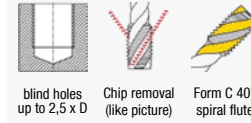

G(BSP)

	D1	D2	L1	L2	□		No.	€	No.	€
BSP 1/8 x 28	9,73	7,0	90	20	5,5	8,80	130601001	19,42	130605001	39,10
BSP 1/4 x 19	13,16	11,0	100	22	9,0	11,80	130601002	24,56	130605002	58,32
BSP 3/8 x 19	16,66	12,0	100	22	9,0	15,25	130601003	31,48	130605003	68,53
BSP 1/2 x 14	20,95	16,0	125	25	12,0	19,00	130601004	44,08	130605004	87,60
BSP 5/8 x 14	22,91	18,0	125	25	14,5	21,00	130601005	51,63	130605005	100,33
BSP 3/4 x 14	26,44	20,0	140	28	16,0	24,50	130601006	65,49	130605006	117,54
BSP 7/8 x 14	30,20	22,0	150	28	18,0	28,25	130601007	80,60	130605007	184,41
BSP 1" x 11	33,25	25,0	160	30	20,0	30,75	130601008	100,75	130605008	243,05
BSP 1.1/8 x 11	37,90	28,0	170	30	22,0	35,30	130601009	147,35	130605009	302,89
BSP 1.1/4 x 11	41,91	32,0	170	30	24,0	39,50	130601010	176,31	130605010	351,14
BSP 1.3/8 x 11	44,32	36,0	180	32	29,0	41,70	130601011	231,72	130605011	413,45
BSP 1.1/2 x 11	47,80	36,0	190	32	29,0	45,25	130601012	251,87	130605012	466,25
BSP 1.3/4 x 11	53,74	40,0	190	32	32,0	51,20	130601013	362,70	130605013	569,58
BSP 2" x 11	59,61	45,0	220	40	35,0	57,00	130601014	403,00	130605014	594,53

G-Rohr (BSP)

British standard whitworth pipe thread / DIN ISO 228

Machine Forming Taps have following advantages:

- No chips
- Up to 20 times longer lifetime (compared to taps)
- Same forming tap for through and blind hole
- Wide range of materials can be processed
- Intersection of the thread is impossible
- Very high trueness
- Increased strength of the thread
- Higher surface quality
- Much higher cutting speed

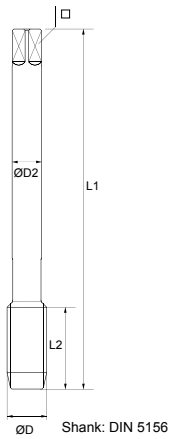

Machine Forming Taps for universal use

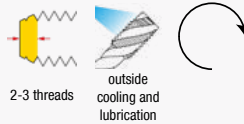
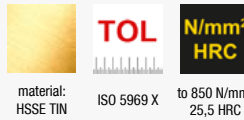

G(BSP)

	D1	D2	L1	L2	□		No.	€
BSP 1/8 x 28	9,73	7,0	90	18	5,5	9,25	131101001	102,04
BSP 1/4 x 19	13,16	11,0	100	22	9,0	12,50	131101002	128,31
BSP 3/8 x 19	16,66	12,0	100	22	9,0	16,00	131101003	160,70
BSP 1/2 x 14	20,95	16,0	125	25	12,0	20,00	131101004	188,59
BSP 3/4 x 14	26,44	20,0	140	28	20,0	25,50	131101005	390,51

Round Dies for general use

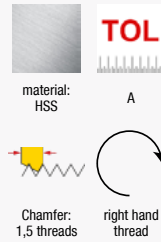

Round Dies for general use Left Hand

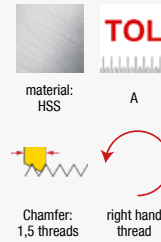

Round Dies for stainless steels

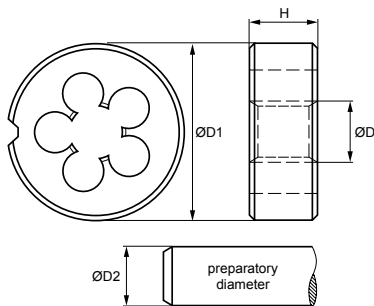
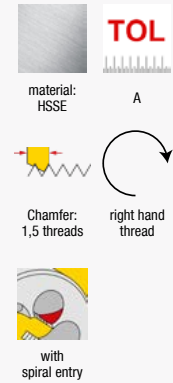

G(BSP)

	D	D1	H	D2	No.	€	No.	€	No.	€
BSP 1/8 x 28	9,73	30	11	9,62	131401001	18,12	131402001	32,74	131405001	28,64
BSP 1/4 x 19	13,16	38	10	13,03	131401002	18,48	131402002	37,42	131405002	28,64
BSP 3/8 x 19	16,66	45	14	16,54	131401003	24,55	131402003	54,95	131405003	42,68
BSP 1/2 x 14	20,95	45	14	20,81	131401004	24,55	131402004	54,95	131405004	42,68
BSP 5/8 x 14	22,91	55	16	22,77	131401005	44,44	131402005	74,26		
BSP 3/4 x 14	26,44	55	16	26,30	131401006	44,44	131402006	92,37	131405005	78,36
BSP 7/8 x 14	30,20	65	18	30,06	131401007	59,64	131402007	101,74		
BSP 1" x 11	33,25	65	18	33,07	131401008	59,64	131402008	101,74	131405006	112,27
BSP 1.1/8 x 11	37,90	75	20	37,72	131401009	100,58	131402009	128,63		
BSP 1.1/4 x 11	41,91	75	20	41,73	131401010	100,58	131402010	128,63		
BSP 1.3/8 x 11	44,32	90	22	44,14	131401011	175,42	131402011	212,84		
BSP 1.1/2 x 11	47,80	90	22	47,62	131401012	175,42	131402012	212,84		
BSP 1.5/8 x 11	52,00	90	22	51,82	131401013	175,42	131402013	212,84		
BSP 1.3/4 x 11	53,74	105	22	53,57	131401014	300,55	131402014	364,87		
BSP 2" x 11	59,61	90	22	59,43	131401015	175,42	131402015	364,87		
BSP 2" x 11	59,61	105	22	59,43	131401016	300,55				
BSP 2.1/4 x 11	65,71	120	22	65,49	131401017	440,78				
BSP 2.1/2 x 11	75,18	120	22	74,97	131401018	589,38				
BSP 2.3/4 x 11	81,53	120	22	81,32	131401019	589,38				
BSP 3" x 11	87,88	130	25	87,67	131401020	652,35				
BSP 3.1/2 x 11	100,33	150	25	100,11	131401021	1.057,87				
BSP 4" x 11	113,03	160	25	112,81	131401022	1.309,74				

Hexagon Die Nuts for general use

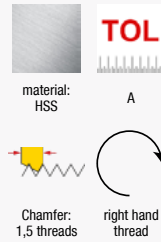

Hexagon Die Nuts for general use Left Hand

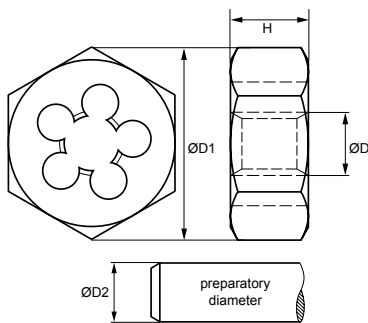
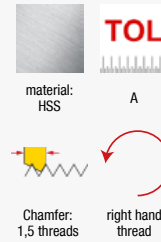

G(BSP)

	D	D1	H	D2	No.	€	No.	€
BSP 1/8 x 28	9,73	27	11	9,62	131501001	20,95	131502001	36,25
BSP 1/4 x 19	13,16	36	10	13,03	131501002	25,01	131502002	40,93
BSP 3/8 x 19	16,66	41	14	16,54	131501003	37,23	131502003	61,40
BSP 1/2 x 14	20,95	41	14	20,81	131501004	37,23	131502004	61,40
BSP 5/8 x 14	22,91	50	16	22,77	131501005	62,24	131502005	81,86
BSP 3/4 x 14	26,44	50	16	26,30	131501006	62,24	131502006	81,86
BSP 7/8 x 14	30,20	60	18	30,06	131501007	84,36		
BSP 1" x 11	33,25	60	18	33,07	131501008	84,36	131502007	105,25
BSP 1.1/8 x 11	37,90	70	20	37,72	131501009	124,50	131502008	163,72
BSP 1.1/4 x 11	41,91	70	20	41,73	131501010	124,50	131502009	163,72
BSP 1.3/8 x 11	44,32	85	22	44,14	131501011	207,12	131502010	270,14
BSP 1.1/2 x 11	47,80	85	22	47,62	131501012	207,12	131502011	270,14
BSP 1.5/8 x 11	52,00	85	22	51,82	131501013	207,12		
BSP 1.3/4 x 11	53,74	100	22	53,57	131501014	310,67	131502012	405,78
BSP 2" x 11	59,61	100	22	59,43	131501015	310,67	131502013	405,78

UNC

Unified coarse thread / ANSI B1.1

BAER Hand-Tap Sets, Round Dies and Tools Sets
(example picture)



BAER Set UNC 1/4" - 1/2"

HSSG Hand Tap Sets & HSS Round Dies & Tools

BAER HSSG Hand Tap Sets (3 parts) UNC 1/4 x 20 | UNC 5/16 x 18 | UNC 3/8 x 16 | UNC 7/16 x 14 | UNC 1/2 x 13

BAER HSS Round Dies UNC 1/4 x 20 | UNC 5/16 x 18 | UNC 3/8 x 16 | UNC 7/16 x 14 | UNC 1/2 x 13

BAER adjustable Tap Wrenches - zinc die cast M 1-10 | 1/16-3/8 | G 1/8 & M 4-12 | 5/32-1/2 | G 1/8

BAER Die Stocks - zinc die cast 20 x 7 | 25 x 9 | 30 x 11 | 38 x 14

Screw extractor

288,03
€/Set

Item No.:
264805003

BAER Set UNC 1/4" - 3/4"

HSSG Hand Tap Sets & HSS Round Dies & Tools

BAER HSSG Hand Tap Sets (3 parts) UNC 1/4 x 20 | UNC 5/16 x 18 | UNC 3/8 x 16 | UNC 7/16 x 14 | UNC 1/2 x 13 | UNC 5/8 x 11 | UNC 3/4 x 10

BAER HSS Round Dies UNC 1/4 x 20 | UNC 5/16 x 18 | UNC 3/8 x 16 | UNC 7/16 x 14 | UNC 1/2 x 13 | UNC 5/8 x 11 | UNC 3/4 x 10

BAER adjustable Tap Wrenches - zinc die cast M 1-10 | 1/16-3/8 | G 1/8 & M 5-20 | 7/32-3/4" | G 1/8-1/2

BAER Die Stocks - zinc die cast 20 x 7 | 25 x 9 | 30 x 11 | 38 x 14 | 45 x 18

Screw extractor

502,74
€/Set

Item No.:
264805103

BAER Set UNC 1/4" - 1"

HSSG Hand Tap Sets & HSS Round Dies & Tools

BAER HSSG Hand Tap Sets (3 parts) UNC 1/4 x 20 | UNC 5/16 x 18 | UNC 3/8 x 16 | UNC 7/16 x 14 | UNC 1/2 x 13 | UNC 5/8 x 11 | UNC 3/4 x 10 | UNC 7/8 x 9 | UNC 1" x 8

BAER HSS Round Dies UNC 1/4 x 20 | UNC 5/16 x 18 | UNC 3/8 x 16 | UNC 7/16 x 14 | UNC 1/2 x 13 | UNC 5/8 x 11 | UNC 3/4 x 10 | UNC 7/8 x 9 | UNC 1" x 8

BAER adjustable Tap Wrenches - zinc die cast M 1-10 | 1/16-3/8 | G 1/8 & M 11-27 | 7/16-1" | G 1/4-3/4

BAER Die Stocks - zinc die cast 20 x 7 | 25 x 9 | 30 x 11 | 38 x 14 | 45 x 18 | 55 x 22

Screw extractor

764,58
€/Set

Item No.:
264805303

BAER Set UNC 1/4" - 1.1/2"

HSSG Hand Tap Sets & HSS Round Dies & Tools

BAER HSSG Hand Tap Sets (3 parts) UNC 1/4 x 20 | UNC 5/16 x 18 | UNC 3/8 x 16 | UNC 7/16 x 14 | UNC 1/2 x 13 | UNC 5/8 x 11 | UNC 3/4 x 10 | UNC 7/8 x 9 | UNC 1" x 8 | UNC 1.1/8" x 7 | UNC 1.1/4" x 7 | UNC 1.1/2" x 6

BAER HSS Round Dies UNC 1/4 x 20 | UNC 5/16 x 18 | UNC 3/8 x 16 | UNC 7/16 x 14 | UNC 1/2 x 13 | UNC 5/8 x 11 | UNC 3/4 x 10 | UNC 7/8 x 9 | UNC 1" x 8 | UNC 1.1/8" x 7 | UNC 1.1/4" x 7 | UNC 1.1/2" x 6

BAER adjustable Tap Wrenches - zinc die cast M 1-10 | 1/16-3/8 | G 1/8 & M 5-20 | 7/32-3/4" | G 1/8-1/2 & M 13-32 | 1/2 - 1.1/4" | G 1/4-1"

BAER Die Stocks - zinc die cast 20 x 7 | 25 x 9 | 30 x 11 | 38 x 14 | 45 x 18 | 55 x 22 | 65 x 25

Screw extractor

1.916,68
€/Set

Item No.:
264805303

BAER Set UNC & UNF 1/4" - 3/4"

HSSG Hand Tap Sets & HSS Round Dies & Tools

BAER HSSG Hand Tap Sets (3 parts) UNC 1/4 | UNC 5/16 | UNC 3/8 | UNC 7/16 | UNC 1/2 | UNC 5/8 | UNC 3/4
BAER HSSG Hand Tap Sets (2 parts) UNF 1/4 | UNF 5/16 | UNF 3/8 | UNF 7/16 | UNF 1/2 | UNF 5/8 | UNF 3/4

BAER HSS Round Dies UNC 1/4 | UNC 5/16 | UNC 3/8 | UNC 7/16 | UNC 1/2 | UNC 5/8 | UNC 3/4
BAER HSS Round Dies UNF 1/4 | UNF 5/16 | UNF 3/8 | UNF 7/16 | UNF 1/2 | UNF 5/8 | UNF 3/4

BAER adjustable Tap Wrenches - zinc die cast M 1-10 | 1/16-3/8 | G 1/8 & M 5-20 | 7/32-3/4" | G 1/8-1/2

BAER Die Stocks - zinc die cast 20 x 7 | 25 x 9 | 30 x 11 | 38 x 14 | 45 x 18

Screw extractor

806,47
€/Set

Item No.:
2648066203

UNC

Unified coarse thread / ANSI B1.1

BAER Short Machine Taps und Round Dies Sets UNC 1/4" - 1/2" (example picture)



BAER Set UNC 1/4" - 1/2" HSSG Short Machine Taps & Drill bits for core holes HSS Round Dies



162,37
€/Set

BAER HSSG Short Machine Tap Form D for through hole & blind hole (up to 4 x D)	UNC 1/4 x 20 UNC 5/16 x 18 UNC 3/8 x 16 UNC 7/16 x 14 UNC 1/2 x 13
BAER HSSG Drill bits for core holes	5,2 mm 6,6 mm 8,0 mm 9,4 mm 10,8 mm
BAER HSS Round Dies	UNC 1/4 x 20 UNC 5/16 x 18 UNC 3/8 x 16 UNC 7/16 x 14 UNC 1/2 x 13

Item No.:
BES2

UNC

Unified coarse thread / ANSI B1.1

Efficient internal thread cutting.

The short structural type makes that tap usable by hand. The Short-Machine-Tap is also usable by machine.

A Hand-Tap-Set includes 3 taps:

- Taper Tap
- Intermediate Tap
- Finish Tap

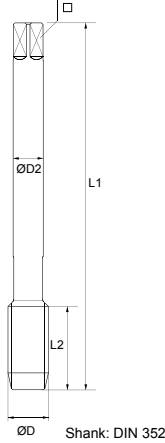

Short Machine Taps

Form D for through holes and blind holes

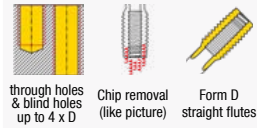

through holes & blind holes up to 4 x D
Chip removal (like picture)
Form D straight flutes
material: HSSG 2B to 900 N/mm² 27,1 HRC

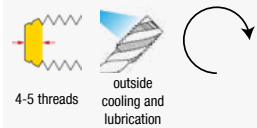

Hand Tap Sets for general use

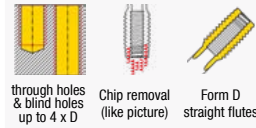

through holes & blind holes up to 4 x D
Chip removal (like picture)
Form D straight flutes
material: HSSG 2B to 900 N/mm² 27,1 HRC

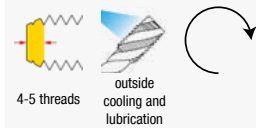

Hand Tap Sets for general use

Left Hand

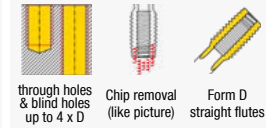

through holes & blind holes up to 4 x D
Chip removal (like picture)
Form D straight flutes
material: HSSG 2B to 900 N/mm² 27,1 HRC

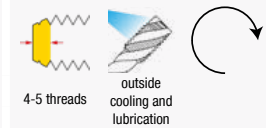

UNC	D1	D2	L1	L2	□		No.	€	No.	€	No.	€
UNC No 1 x 64	1,85	2,5	32	10	2,1	1,50			140301001	20,95		
UNC No 2 x 56	2,18	2,8	36	11	2,1	1,80			140301002	20,95		
UNC No 3 x 48	2,52	2,8	36	11	2,1	2,10			140301003	20,95		
UNC No 4 x 40	2,85	3,5	40	12	2,7	2,30			140301004	17,48		
UNC No 5 x 40	3,18	3,5	40	12	2,7	2,60			140301005	14,70		
UNC No 6 x 32	3,51	4,0	45	14	3,0	2,85			140301006	14,70	140302001	38,24
UNC No 8 x 32	4,17	4,5	45	14	3,4	3,50			140301007	14,70	140302002	38,24
UNC No 10 x 24	4,83	6,0	50	16	4,9	3,90			140301008	14,70	140302003	38,24
UNC No 12 x 24	5,49	6,0	50	18	4,9	4,50			140301009	14,70	140302004	38,24
UNC 1/4 x 20	6,35	6,0	50	19	4,9	5,20	140101001	4,90	140301010	14,70	140302005	24,21
UNC 5/16 x 18	7,94	6,0	56	22	4,9	6,60	140101002	5,50	140301011	16,38	140302006	25,26
UNC 3/8 x 16	9,53	7,0	70	24	5,5	8,00	140101003	6,08	140301012	18,17	140302007	29,47
UNC 7/16 x 14	11,11	8,0	70	24	6,2	9,40	140101004	7,72	140301013	23,05	140302008	36,14
UNC 1/2 x 13	12,70	9,0	75	29	7,0	10,80	140101005	9,36	140301014	27,93	140302009	43,16
UNC 9/16 x 12	14,29	11,0	80	30	9,0	12,20	140101006	12,27	140301015	36,65	140302010	56,13
UNC 5/8 x 11	15,88	12,0	80	32	9,0	13,50	140101007	13,80	140301016	41,19	140302011	63,85
UNC 3/4 x 10	19,05	14,0	95	40	11,0	16,50	140101008	18,48	140301017	55,16	140302012	85,25
UNC 7/8 x 9	22,23	18,0	100	40	14,5	19,50	140101009	24,56	140301018	73,30	140302013	106,30
UNC 1" x 8	25,40	18,0	110	50	14,5	22,25	140101010	28,30	140301019	84,48	140302014	127,70
UNC 1.1/8 x 7	28,58	22,0	132	56	18,0	25,00			140301020	130,20		
UNC 1.1/4 x 7	31,75	22,0	132	56	18,0	28,25			140301021	146,61		
UNC 1.3/8 x 6	34,93	28,0	150	63	22,0	30,75			140301022	190,59		
UNC 1.1/2 x 6	38,10	32,0	150	63	24,0	34,00			140301023	219,90		
UNC 1.5/8 x 5	41,28	32,0	160	70	24,0	37,10			140301024	439,82		
UNC 1.3/4 x 5	44,45	36,0	160	70	29,0	39,50			140301025	439,82		
UNC 1.7/8 x 4,5	47,63	36,0	190	80	29,0	42,00			140301026	572,47		
UNC 2" x 4,5	50,80	40,0	190	80	32,0	45,00			140301027	572,47		
UNC 2.1/4 x 4,5	57,15	45,0	220	80	35,0	51,50			140301028	1.473,46		
UNC 2.1/2 x 4	63,50	50,0	220	80	39,0	57,25			140301029	1.964,61		
UNC 2.3/4 x 4	69,85	50,0	240	80	39,0	63,50			140301030	4.911,54		
UNC 3" x 4	73,20	50,0	260	80	39,0	70,00			140301031	6.044,97		

UNC

Unified coarse thread / ANSI B1.1

- ✓ Tap for machine use in through hole.
- ✓ The spiral point pushes the chips ahead.

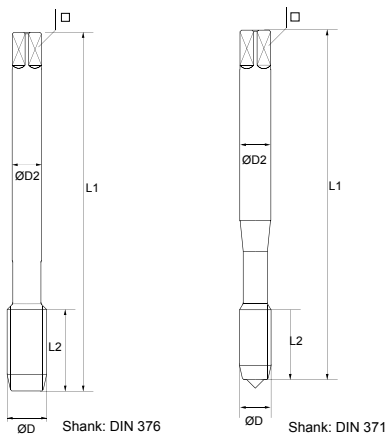

Machine Tap for general use

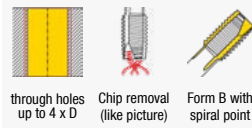

through holes up to 4 x D
Chip removal (like picture)
Form B with spiral point

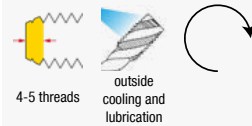
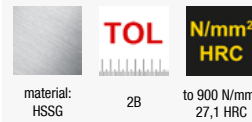

Machine Tap for stainless steels

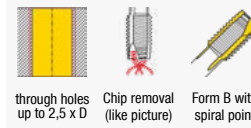

through holes up to 2.5 x D
Chip removal (like picture)
Form B with spiral point

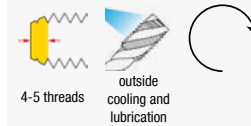
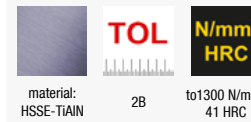

UNC

	D1	D2	L1	L2	□	🔩	No.	€	No.	€
DIN 371										
UNC No 2 x 56	2,18	2,8	45	8	2,1	1,85			140405001	46,26
UNC No 3 x 48	2,52	2,8	50	9	2,1	2,10			140405002	54,14
UNC No 4 x 40	2,85	3,5	50	10	2,7	2,30	140401001	10,81	140405003	37,30
UNC No 5 x 40	3,18	3,5	56	11	2,7	2,60	140401002	10,81	140405004	34,13
UNC No 6 x 32	3,51	4,0	56	12	3,0	2,85	140401003	10,81	140405005	35,84
UNC No 8 x 32	4,17	4,5	63	13	3,4	3,50	140401004	10,81	140405006	30,93
UNC No 10 x 24	4,83	6,0	70	15	4,9	3,90	140401005	10,81	140405007	34,09
UNC No 12 x 24	5,49	6,0	70	16	4,9	4,50	140401006	10,81	140405008	35,70
UNC 1/4 x 20	6,35	7,0	80	17	5,5	5,20	140401007	10,81	140405009	37,22
UNC 5/16 x 18	7,94	8,0	90	20	6,2	6,60	140401008	13,75		
UNC 3/8 x 16	9,53	9,0	100	22	7,0	8,00	140401009	15,32		
DIN 376										
UNC No 4 x 40	2,85	1,8	50	10	-	2,30	140401010	10,81		
UNC No 5 x 40	3,18	2,2	56	11	1,8	2,60	140401011	10,81		
UNC No 6 x 32	3,51	2,5	56	12	2,1	2,85	140401012	10,81		
UNC No 8 x 32	4,17	2,8	63	13	2,1	3,50	140401013	10,81		
UNC No 10 x 24	4,83	3,5	70	15	2,7	3,90	140401014	10,81		
UNC No 12 x 24	5,49	3,5	70	16	2,7	4,50	140401015	10,81		
UNC 1/4 x 20	6,35	4,5	80	17	3,4	5,20	140401016	10,81		
UNC 5/16 x 18	7,94	6,0	90	20	4,9	6,60	140401017	13,75	140405010	39,54
UNC 3/8 x 16	9,53	7,0	100	22	5,5	8,00	140401018	15,32	140405011	46,44
UNC 7/16 x 14	11,11	8,0	100	22	6,2	9,40	140401019	18,26	140405012	60,64
UNC 1/2 x 13	12,70	9,0	110	25	7,0	10,80	140401020	18,26	140405013	60,64
UNC 9/16 x 12	14,29	11,0	110	26	9,0	12,20	140401021	27,81	140405014	79,40
UNC 5/8 x 11	15,88	12,0	110	27	9,0	13,50	140401022	27,81	140405015	89,20
UNC 3/4 x 10	19,05	14,0	125	30	11,0	16,50	140401023	54,15	140405016	152,73
UNC 7/8 x 9	22,23	18,0	140	32	14,5	19,50	140401024	65,49	140405017	188,08
UNC 1" x 8	25,40	20,0	160	36	16,0	22,25	140401025	74,30	140405018	247,63
UNC 1.1/4 x 7	31,75	22,0	180	40	18,0	28,25	140401026	103,90		
UNC 1.1/2 x 6	38,10	32,0	200	50	24,0	34,00	140401027	216,61		
UNC 1.3/4 x 5	44,45	36,0	220	65	29,0	39,50	140401028	371,51		
UNC 2" x 4,5	50,80	40,0	250	70	32,0	45,00	140401029	536,49		

Machine Taps - Form C (with spiral flutes) for blind holes

UNC

Unified coarse thread / ANSI B1.1

- ✓ Tap for machine use in blind holes.
- ✓ The fast spiral flutes provide good chip removal from the blind hole.

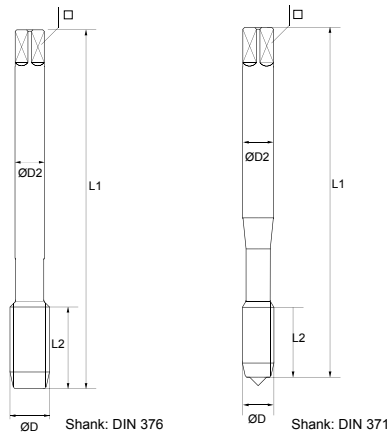

Machine Tap for general use

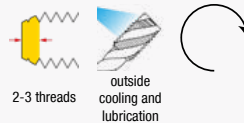
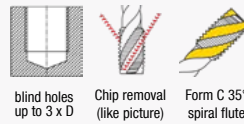

Machine Tap for stainless steels

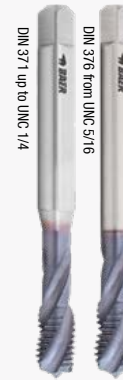
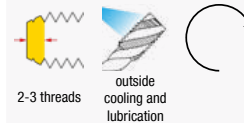
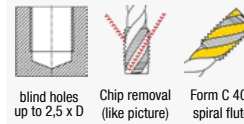

UNC

	D1	D2	L1	L2	□		No.	€	No.	€
DIN 371										
UNC No 2 x 56	2,18	2,8	45	6	2,1	1,85			140605001	65,82
UNC No 3 x 48	2,52	2,8	50	7	2,1	2,10			140605002	59,31
UNC No 4 x 40	2,85	3,5	50	6	2,7	2,30	140601001	13,43	140605003	39,77
UNC No 5 x 40	3,18	3,5	56	7	2,7	2,60	140601002	13,43	140605004	33,42
UNC No 6 x 32	3,51	4,0	56	7	3,0	2,85	140601003	13,43	140605005	33,42
UNC No 8 x 32	4,17	4,5	63	8	3,4	3,50	140601004	13,43	140605006	33,42
UNC No 10 x 24	4,83	6,0	70	10	4,9	3,90	140601005	13,43	140605007	34,23
UNC No 12 x 24	5,49	6,0	70	10	4,9	4,50	140601006	13,43	140605008	34,23
UNC 1/4 x 20	6,35	7,0	80	13	5,5	5,20	140601007	13,43	140605009	34,23
UNC 5/16 x 18	7,94	8,0	90	14	6,2	6,60	140601008	16,90		
UNC 3/8 x 16	9,53	9,0	100	16	7,0	8,00	140601009	18,47		
DIN 376										
UNC No 4 x 40	2,85	1,8	50	10	-	2,30	140601010	13,43		
UNC No 5 x 40	3,18	2,2	56	11	1,8	2,60	140601011	13,43		
UNC No 6 x 32	3,51	2,5	56	12	2,1	2,85	140601012	13,43		
UNC No 8 x 32	4,17	2,8	63	13	2,1	3,50	140601013	13,43		
UNC No 10 x 24	4,83	3,5	70	15	2,7	3,90	140601014	13,43		
UNC No 12 x 24	5,49	3,5	70	16	2,7	4,50	140601015	13,43		
UNC 1/4 x 20	6,35	4,5	80	17	3,4	5,20	140601016	13,43		
UNC 5/16 x 18	7,94	6,0	90	20	4,9	6,60	140601017	16,90	140605010	42,03
UNC 3/8 x 16	9,53	7,0	100	22	5,5	8,00	140601018	18,47	140605011	48,92
UNC 7/16 x 14	11,11	8,0	100	22	6,2	9,40	140601019	22,77	140605012	63,12
UNC 1/2 x 13	12,70	9,0	110	25	7,0	10,80	140601020	22,77	140605013	63,12
UNC 9/16 x 12	14,29	11,0	110	26	9,0	12,20	140601021	33,58	140605014	81,88
UNC 5/8 x 11	15,88	12,0	110	27	9,0	13,50	140601022	33,58	140605015	91,68
UNC 3/4 x 10	19,05	14,0	125	30	11,0	16,50	140601023	66,96	140605016	155,21
UNC 7/8 x 9	22,23	18,0	140	32	14,5	19,50	140601024	81,86	140605017	190,55
UNC 1" x 8	25,40	20,0	160	36	16,0	22,25	140601025	91,93	140605018	250,11
UNC 1.1/4 x 7	31,75	22,0	180	40	18,0	28,25	140601026	117,12		
UNC 1.1/2 x 6	38,10	32,0	200	50	24,0	34,00	140601027	255,65		
UNC 1.3/4 x 5	44,45	36,0	220	65	29,0	39,50	140601028	403,00		
UNC 2" x 4,5	50,80	40,0	250	70	32,0	45,00	140601029	571,75		

UNC

Unified coarse thread / ANSI B1.1

Machine Forming Taps have following advantages:

- No chips
- Up to 20 times longer lifetime (compared to taps)
- Same forming tap for through and blind hole
- Wide range of materials can be processed
- Intersection of the thread is impossible
- Very high trueness
- Increased strength of the thread
- Higher surface quality
- Much higher cutting speed

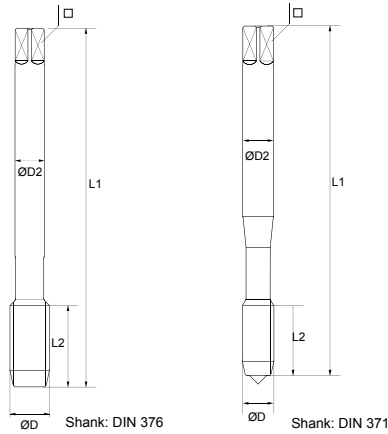

Machine Forming Taps for universal use

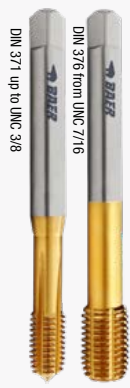

UNC	D1	D2	L1	L2	□	✂	No.	€
UNC No 4 x 40	2,85	3,5	56	11	2,7	2,55	141101001	*
UNC No 5 x 40	3,18	3,5	56	10	2,7	2,65	141101002	*
UNC No 6 x 32	3,51	4,0	56	12	3,0	3,15	141101003	*
UNC No 8 x 32	4,17	4,5	63	13	3,4	3,80	141101004	*
UNC No 10 x 24	4,83	6,0	70	15	4,9	4,35	141101005	*
UNC No 12 x 24	5,49	6,0	80	16	4,9	5,00	141101006	*
UNC 1/4 x 20	6,35	7,0	80	17	5,5	5,75	141101007	*
UNC 5/16 x 18	7,94	8,0	90	20	6,2	7,30	141101008	*
UNC 3/8 x 16	9,53	10,0	100	22	8,0	8,80	141101009	*
UNC 7/16 x 14	11,11	8,0	100	22	6,2	10,25	141101010	*
UNC 1/2 x 13	12,70	9,0	110	25	7,0	11,80	141101011	*
UNC 9/16 x 12	14,29	11,0	110	26	9,0	13,30	141101012	*
UNC 5/8 x 11	15,88	12,0	110	27	9,0	14,80	141101013	*
UNC 3/4 x 10	19,05	14,0	125	30	11,0	17,85	141101014	*

* on request

UNC

Unified coarse thread / ANSI B1.1

Efficient internal thread cutting with battery powered screwdriver (min. 7,5 Volt).

Core hole drilling and thread tapping in one fluent process.

Application:

- non abrasive material up to 600 N/mm²
- unalloyed and low alloyed steel

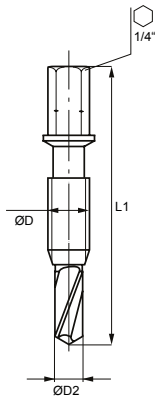

Kombi-Bit-Taps for through holes

through holes up to 1 x D Chip removal (like picture) Combined form

material: HSSG 2B to 600 N/mm² **HRC**

4-5 threads outside cooling and lubrication



UNC

	D1	D2	L1		No.	€
UNC No 4 x 40	2,85	2,3	36	1/4"	141301001	*
UNC No 5 x 40	3,18	2,6	36	1/4"	141301002	*
UNC No 6 x 32	3,51	2,9	39	1/4"	141301003	*
UNC No 8 x 32	4,17	3,5	39	1/4"	141301004	*
UNC No 10 x 24	4,83	3,9	41	1/4"	141301005	*
UNC No 12 x 24	5,49	4,5	41	1/4"	141301006	*
UNC 1/4 x 20	6,35	5,2	44	1/4"	141301007	*
UNC 5/16 x 18	7,94	6,6	50	1/4"	141301008	*
UNC 3/8 x 16	9,53	8,0	59	1/4"	141301009	*

* on request

Round Dies for general use



material: HSS 2A

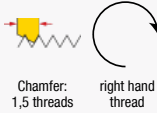

Round Dies for general use Left Hand



material: HSS 2A

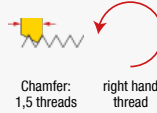

Round Dies for stainless steels



material: HSSE 2A

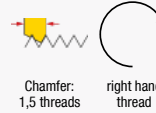

with spiral entry

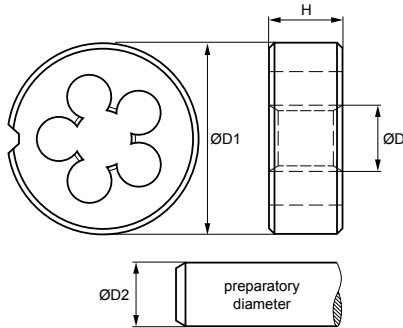
UNC

	D	D1	H	D2	No.	€	No.	€	No.	€
UNC No 1 x 64	1,85	16	5	1,79	141401001	16,75				
UNC No 2 x 56	2,18	16	5	2,12	141401002	16,75				
UNC No 3 x 48	2,52	16	5	2,44	141401003	16,75				
UNC No 4 x 40	2,85	20	5	2,76	141401004	13,76			141405001	111,53
UNC No 5 x 40	3,18	20	5	3,09	141401005	12,92				
UNC No 6 x 32	3,51	20	7	3,41	141401006	12,92	141402001	23,38	141405002	94,97
UNC No 8 x 32	4,17	20	7	4,07	141401007	12,92	141402002	23,38	141405003	85,84
UNC No 10 x 24	4,83	20	7	4,71	141401008	12,92	141402003	23,38		
UNC No 12 x 24	5,49	20	7	5,37	141401009	12,92				
UNC 1/4 x 20	6,35	20	7	6,22	141401010	12,29	141402004	18,94	141405004	79,09
UNC 5/16 x 18	7,94	25	9	7,80	141401011	14,03	141402005	22,10	141405005	112,54
UNC 3/8 x 16	9,53	30	11	9,37	141401012	15,56	141402006	26,90	141405006	118,63
UNC 7/16 x 14	11,11	30	11	10,95	141401013	18,01	141402007	26,90		
UNC 1/2 x 13	12,70	38	14	12,52	141401014	20,23	141402008	42,09		
UNC 9/16 x 12	14,29	38	14	14,10	141401015	25,03	141402009	42,09		
UNC 5/8 x 11	15,88	45	18	15,68	141401016	27,36	141402010	53,80		
UNC 3/4 x 10	19,05	45	18	18,84	141401017	27,36	141402011	53,80		
UNC 7/8 x 9	22,23	55	22	22,00	141401018	46,77	141402012	78,35		
UNC 1" x 8	25,40	55	22	25,16	141401019	46,77	141402013	78,35		
UNC 1.1/8 x 7	28,58	65	25	28,31	141401020	70,76				
UNC 1.1/4 x 7	31,75	65	25	31,49	141401021	70,76				
UNC 1.3/8 x 6	34,93	65	25	34,63	141401022	70,76				
UNC 1.1/2 x 6	38,10	65	25	37,80	141401023	70,76				
UNC 1.1/2 x 6	38,10	75	30	37,80	141401024	126,30				
UNC 1.5/8 x 5	41,28	75	30	40,95	141401025	126,30				
UNC 1.3/4 x 5	44,45	90	36	44,12	141401026	192,96				
UNC 1.7/8 x 4,5	47,63	90	36	47,30	141401027	192,96				
UNC 2" x 4,5	50,80	90	36	50,45	141401028	192,96				

Hexagon Die Nuts for general use



material: HSS 2A

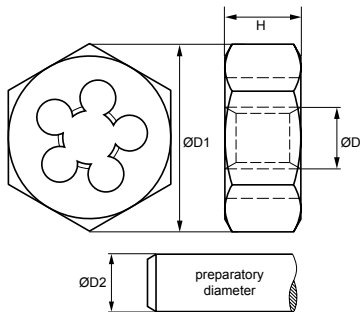

Chamfer: 1,5 threads right hand thread

UNC

	D	D1	H	D2	No.	€
UNC 1/4 x 20	6,35	19	7	6,22	141501001	15,20
UNC 5/16 x 18	7,94	22	9	7,80	141501002	15,78
UNC 3/8 x 16	9,53	27	11	9,37	141501003	19,07
UNC 7/16 x 14	11,11	27	11	10,95	141501004	19,07
UNC 1/2 x 13	12,70	36	14	12,52	141501005	23,38
UNC 9/16 x 12	14,29	36	14	14,10	141501006	23,38
UNC 5/8 x 11	15,88	41	18	15,68	141501007	31,93
UNC 3/4 x 10	19,05	41	18	18,84	141501008	31,93
UNC 7/8 x 9	22,23	50	22	22,00	141501009	66,32
UNC 1" x 8	25,40	50	22	25,16	141501010	66,32
UNC 1.1/8 x 7	28,58	60	25	28,31	141501011	100,58
UNC 1.1/4 x 7	31,75	60	25	31,49	141501012	100,58
UNC 1.3/8 x 6	34,93	60	25	34,63	141501013	100,58
UNC 1.1/2 x 6	38,10	70	30	37,80	141501014	115,65

BAER Hand-Tap Sets, Round Dies and Tools Sets (example picture)



BAER Set UNF 1/4" - 1/2" HSSG Hand Tap Sets & HSS Round Dies & Tools

267,62
€/Set

BAER HSSG Hand Tap Sets (2 parts)	UNF 1/4 x 28 UNF 5/16 x 24 UNF 3/8 x 24 UNF 7/16 x 20 UNF 1/2 x 20
BAER HSS Round Dies	UNF 1/4 x 28 UNF 5/16 x 24 UNF 3/8 x 24 UNF 7/16 x 20 UNF 1/2 x 20
BAER adjustable Tap Wrenches - zinc die cast	M 1-10 1/16-3/8 G 1/8 & M 4-12 5/32-1/2 G 1/8
BAER Die Stocks - zinc die cast	20 x 7 25 x 9 30 x 11 38 x 10
Screw extractor	

 Item No.:
264806004

BAER Set UNF 1/4" - 3/4" HSSG Hand Tap Sets & HSS Round Dies & Tools

446,03
€/Set

BAER HSSG Hand Tap Sets (2 parts)	UNF 1/4 x 28 UNF 5/16 x 24 UNF 3/8 x 24 UNF 7/16 x 20 UNF 1/2 x 20 UNF 5/8 x 18 UNF 3/4 x 16
BAER HSS Round Dies	UNF 1/4 x 28 UNF 5/16 x 24 UNF 3/8 x 24 UNF 7/16 x 20 UNF 1/2 x 20 UNF 5/8 x 18 UNF 3/4 x 16
BAER adjustable Tap Wrenches - zinc die cast	M 1-10 1/16-3/8 G 1/8 & M 5-20 7/32-3/4" G 1/8-1/2
BAER Die Stocks - zinc die cast	20 x 7 25 x 9 30 x 11 38 x 10 45 x 14
Screw extractor	

 Item No.:
264806104

BAER Set UNF 1/4" - 1" HSSG Hand Tap Sets & HSS Round Dies & Tools

671,66
€/Set

BAER HSSG Hand Tap Sets (2 parts)	UNF 1/4 x 28 UNF 5/16 x 24 UNF 3/8 x 24 UNF 7/16 x 20 UNF 1/2 x 20 UNF 5/8 x 18 UNF 3/4 x 16 UNF 7/8 x 14 UNF 1" x 12
BAER HSS Round Dies	UNF 1/4 x 28 UNF 5/16 x 24 UNF 3/8 x 24 UNF 7/16 x 20 UNF 1/2 x 20 UNF 5/8 x 18 UNF 3/4 x 16 UNF 7/8 x 14 UNF 1" x 12
BAER adjustable Tap Wrenches - zinc die cast	M 1-10 1/16-3/8 G 1/8 & M 11-27 7/16-1" G 1/4-3/4
BAER Die Stocks - zinc die cast	20 x 7 25 x 9 30 x 11 38 x 10 45 x 14 55 x 16
Screw extractor	

 Item No.:
264806304

BAER Set UNC & UNF 1/4" - 3/4" HSSG Hand Tap Sets & HSS Round Dies & Tools

806,47
€/Set

BAER HSSG Hand Tap Sets (3 parts) UNC	UNC 1/4 UNC 5/16 UNC 3/8 UNC 7/16 UNC 1/2 UNC 5/8 UNC 3/4
BAER HSSG Hand Tap Sets (2 parts) UNF	UNF 1/4 UNF 5/16 UNF 3/8 UNF 7/16 UNF 1/2 UNF 5/8 UNF 3/4
BAER HSS Round Dies UNC	UNC 1/4 UNC 5/16 UNC 3/8 UNC 7/16 UNC 1/2 UNC 5/8 UNC 3/4
BAER HSS Round Dies UNF	UNF 1/4 UNF 5/16 UNF 3/8 UNF 7/16 UNF 1/2 UNF 5/8 UNF 3/4
BAER adjustable Tap Wrenches - zinc die cast	M 1-10 1/16-3/8 G 1/8 & M 5-20 7/32-3/4" G 1/8-1/2
BAER Die Stocks - zinc die cast	20 x 7 25 x 9 30 x 11 38 x 14 45 x 18
Screw extractor	

 Item No.:
264806203

UNF

Unified fine thread / ANSI B1.1

BAER Short Machine Taps und Round Dies Sets UNF 1/4" - 1/2" (example picture)



BAER Set UNF 1/4" - 1/2" HSSG Short Machine Taps & Drill bits for core holes HSS Round Dies

181,37
€/Set

Item No.:
BES3

BAER HSSG Short Machine Tap Form D for through hole & blind hole (up to 4 x D)	UNF 1/4 x 28 UNF 5/16 x 24 UNF 3/8 x 24 UNF 7/16 x 20 UNF 1/2 x 20
BAER HSSG Drill bits for core holes	5,5 mm 6,9 mm 8,5 mm 9,9 mm 11,5 mm
BAER HSS Round Dies	UNF 1/4 x 28 UNF 5/16 x 24 UNF 3/8 x 24 UNF 7/16 x 20 UNF 1/2 x 20

UNF

Unified fine thread / ANSI B1.1

Efficient internal thread cutting.

The short structural type makes that tap usable by hand. The Short-Machine-Tap is also usable by machine.

A Hand-Tap-Set includes 2 taps:

- Taper Tap
- Finish Tap

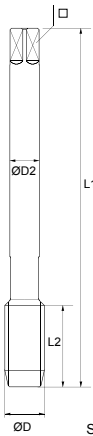

Shank: DIN 2181

Short Machine Taps

Form D for through holes and blind holes

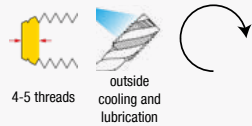
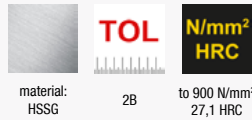
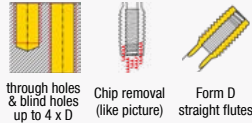

Hand Tap Sets for general use

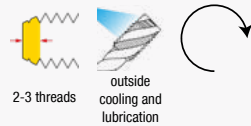
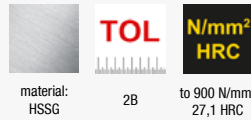
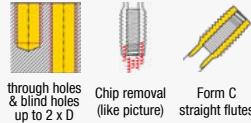

Hand Tap Sets for general use

Left Hand

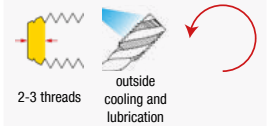
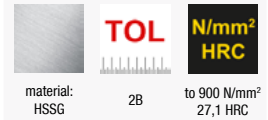
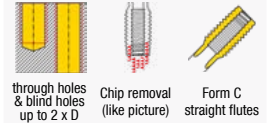

UNF

	D1	D2	L1	L2	□		No.	€	No.	€	No.	€
UNF No 0 x 80	1,52	2,5	28	8	2,1	1,30			150301001	14,03		
UNF No 1 x 72	1,85	2,8	32	9	2,1	1,60			150301002	14,03		
UNF No 2 x 64	2,18	2,8	32	10	2,1	1,90			150301003	14,03		
UNF No 3 x 56	2,52	2,8	32	10	2,1	2,10			150301004	14,03		
UNF No 4 x 48	2,85	3,5	36	11	2,7	2,40			150301005	11,70		
UNF No 5 x 44	3,18	3,5	36	11	2,7	2,70			150301006	9,82		
UNF No 6 x 40	3,51	4,5	40	12	3,4	3,00			150301007	9,82		
UNF No 8 x 36	4,17	4,5	40	12	3,4	3,50			150301008	9,82		
UNF No 10 x 32	4,83	6,0	45	14	4,9	4,10			150301009	9,82	150302001	25,49
UNF No 12 x 28	5,49	6,0	50	14	4,9	4,70			150301010	9,82		
UNF 1/4 x 28	6,35	6,0	50	18	4,9	5,50	150101001	4,90	150301011	9,83	150302002	16,14
UNF 5/16 x 24	7,94	6,0	56	22	4,9	6,90	150101002	5,50	150301012	10,99	150302003	16,84
UNF 3/8 x 24	9,53	7,0	63	22	5,5	8,50	150101003	6,08	150301013	12,16	150302004	19,65
UNF 7/16 x 20	11,11	8,0	63	22	6,2	9,90	150101004	7,72	150301014	15,44	150302005	24,09
UNF 1/2 x 20	12,70	9,0	75	24	7,0	11,50	150101005	9,36	150301015	18,71	150302006	28,77
UNF 9/16 x 18	14,29	11,0	80	28	9,0	12,90	150101006	12,27	150301016	24,56	150302007	37,42
UNF 5/8 x 18	15,88	12,0	80	28	9,0	14,50	150101007	13,80	150301017	27,60	150302008	42,57
UNF 3/4 x 16	19,05	14,0	95	32	11,0	17,50	150101008	18,48	150301018	36,95	150302009	56,84
UNF 7/8 x 14	22,23	18,0	100	36	14,5	20,25	150101009	24,56	150301019	49,12	150302010	70,88
UNF 1" x 12	25,40	18,0	110	40	14,5	23,25	150101010	28,30	150301020	56,61	150302011	85,13
UNF 1" x 14	25,40	18,0	110	40	14,5	23,30			150301021	61,29		
UNF 1.1/8 x 12	28,58	22,0	110	50	18,0	26,50			150301022	87,24		
UNF 1.1/4 x 12	31,75	22,0	132	56	18,0	29,50			150301023	98,24		
UNF 1.3/8 x 12	34,93	28,0	132	56	22,0	32,50			150301024	127,70		
UNF 1.1/2 x 12	38,10	32,0	150	63	24,0	36,00			150301025	147,35		

UNF

Unified fine thread / ANSI B1.1

- ✓ Tap for machine use in through hole.
- ✓ The spiral point pushes the chips ahead.

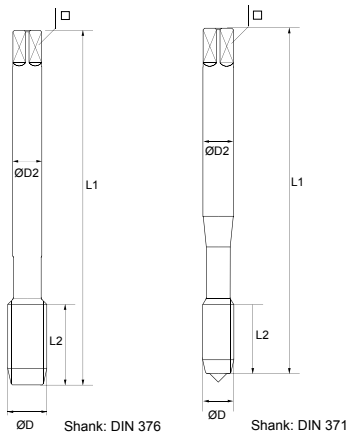

Machine Tap for general use



through holes up to 4 x D
Chip removal (like picture)
Form B with spiral point



material: HSSG 2B to 900 N/mm² 27,1 HRC

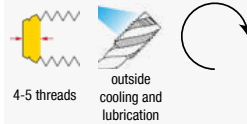

4-5 threads outside cooling and lubrication

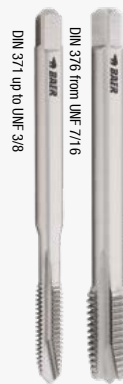

Machine Tap for stainless steels



through holes up to 2,5 x D
Chip removal (like picture)
Form B with spiral point



material: HSSE-TiAlN 2B to 1300 N/mm² 41 HRC

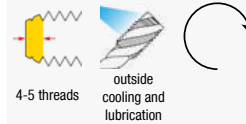

4-5 threads outside cooling and lubrication

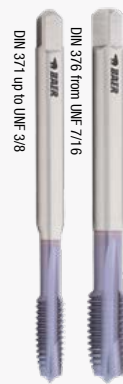

UNF

	D1	D2	L1	L2	□	⚙️	No.	€	No.	€
UNF No 3 x 56	2,52	2,8	50	9	2,1	2,10			150405001	50,17
UNF No 4 x 48	2,85	3,5	50	10	2,7	2,40	150401001	10,81	150405002	42,44
UNF No 5 x 44	3,18	3,5	56	11	2,7	2,70	150401002	10,81	150405003	40,88
UNF No 6 x 40	3,51	4,0	56	12	3,0	3,00	150401003	10,81	150405004	40,88
UNF No 8 x 36	4,17	4,5	63	13	3,4	3,50	150401004	10,81	150405005	41,80
UNF No 10 x 32	4,83	6,0	70	15	4,9	4,10	150401005	10,81	150405006	48,46
UNF No 12 x 28	5,49	6,0	70	16	4,9	4,70	150401006	10,81	150405007	52,57
UNF 1/4 x 28	6,35	7,0	80	17	5,5	5,50	150401007	10,81	150405008	52,57
UNF 5/16 x 24	7,94	8,0	90	17	6,2	6,90	150401008	13,75	150405009	57,02
UNF 3/8 x 24	9,53	9,0	100	18	7,0	8,50	150401009	15,32	150405010	65,05
UNF 7/16 x 20	11,11	8,0	100	22	6,2	9,90	150401010	18,26	150405011	78,75
UNF 1/2 x 20	12,70	9,0	100	22	7,0	11,50	150401011	18,26	150405012	78,75
UNF 9/16 x 18	14,29	11,0	100	22	9,0	12,90	150401012	27,81	150405013	87,80
UNF 5/8 x 18	15,88	12,0	100	22	9,0	14,50	150401013	27,81	150405014	110,20
UNF 3/4 x 16	19,05	14,0	110	25	11,0	17,50	150401014	54,15	150405015	156,07
UNF 7/8 x 14	22,23	18,0	140	26	14,5	20,25	150401015	65,49	150405016	179,35
UNF 1" x 12	25,40	20,0	150	28	16,0	23,25	150401016	74,30	150405017	228,68
UNF 1" x 14	25,40	20,0	150	28	16,0	23,30	150401017	74,30		
UNF 1.1/4 x 12	31,75	22,0	150	30	18,0	29,50	150401018	103,90		
UNF 1.1/2 x 12	38,10	32,0	170	33	24,0	36,00	150401019	216,61		

Machine Taps - Form C (with spiral flutes) for blind holes

UNF

Unified fine thread / ANSI B1.1

- ✓ Tap for machine use in blind holes.
- ✓ The fast spiral flutes provide good chip removal from the blind hole.

Machine Tap for general use

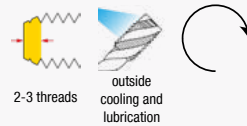
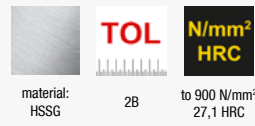
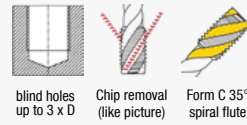

Machine Tap for stainless steels

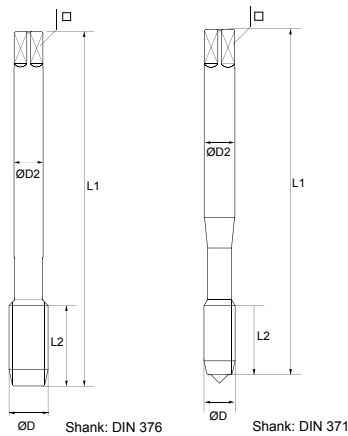
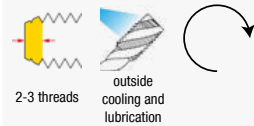
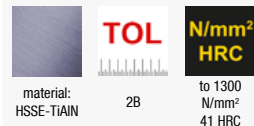
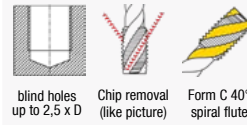

UNF

	D1	D2	L1	L2	□		No.	€	No.	€
UNF No 3 x 56	2,52	2,8	50	6	2,1	2,10			150605001	52,55
UNF No 4 x 48	2,85	3,5	50	6	2,7	2,40	150601001	13,43	150605002	50,17
UNF No 5 x 44	3,18	3,5	56	7	2,7	2,70	150601002	13,43	150605003	49,09
UNF No 6 x 40	3,51	4,0	56	7	3,0	3,00	150601003	13,43	150605004	51,33
UNF No 8 x 36	4,17	4,5	63	8	3,4	3,50	150601004	13,43	150605005	51,33
UNF No 10 x 32	4,83	6,0	70	10	4,9	4,10	150601005	13,43	150605006	48,24
UNF No 12 x 28	5,49	6,0	70	10	4,9	4,70	150601006	13,43	150605007	57,24
UNF 1/4 x 28	6,35	7,0	80	10	5,5	5,50	150601007	13,43	150605008	50,35
UNF 5/16 x 24	7,94	8,0	90	10	6,2	6,90	150601008	16,90	150605009	56,32
UNF 3/8 x 24	9,53	9,0	100	10	7,0	8,50	150601009	18,47	150605010	63,93
UNF 7/16 x 20	11,11	8,0	100	13	6,2	9,90	150601010	22,77	150605011	80,18
UNF 1/2 x 20	12,70	9,0	100	13	7,0	11,50	150601011	22,77	150605012	95,14
UNF 9/16 x 18	14,29	11,0	100	15	9,0	12,90	150601012	33,58	150605013	93,30
UNF 5/8 x 18	15,88	12,0	100	15	9,0	14,50	150601013	33,58	150605014	116,80
UNF 3/4 x 16	19,05	14,0	110	17	11,0	17,50	150601014	66,96	150605015	164,99
UNF 7/8 x 14	22,23	18,0	140	17	14,5	20,25	150601015	81,86	150605016	189,47
UNF 1" x 12	25,40	20,0	150	20	16,0	23,25	150601016	91,93	150605017	241,25
UNF 1" x 14	25,40	20,0	150	20	16,0	23,30	150601017	91,93		
UNF 1.1/4 x 12	31,75	22,0	150	22	18,0	29,50	150601018	117,12		
UNF 1.1/2 x 12	38,10	32,0	170	25	24,0	36,00	150601019	255,65		

UNF

Unified fine thread / ANSI B1.1

Machine Forming Taps have following advantages:

- No chips
- Up to 20 times longer lifetime (compared to taps)
- Same forming tap for through and blind hole
- Wide range of materials can be processed
- Intersection of the thread is impossible
- Very high trueness
- Increased strength of the thread
- Higher surface quality
- Much higher cutting speed

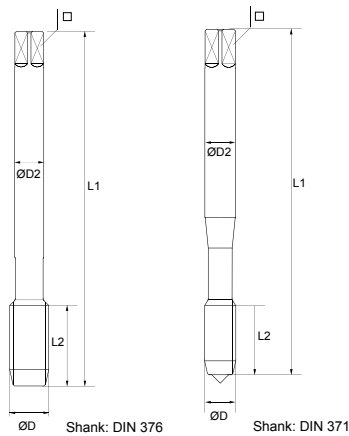

Machine Forming Taps for universal use

UNF	D1	D2	L1	L2	□	🔩	No.	€
UNF No 2 x 64	2,18	2,8	45	7	2,1	2,02	151101001	*
UNF No 4 x 48	2,85	3,5	56	11	2,7	2,62	151101002	*
UNF No 6 x 40	3,51	4,0	56	12	3,0	3,22	151101003	*
UNF No 8 x 36	4,17	4,5	63	13	3,4	3,85	151101004	*
UNF No 10 x 32	4,83	6,0	70	15	4,9	4,45	151101005	*
UNF 1/4 x 28	6,35	7,0	80	17	5,5	5,95	151101006	*
UNF 5/16 x 24	7,94	8,0	90	17	6,2	7,45	151101007	*
UNF 3/8 x 24	9,53	10,0	90	18	8,0	9,05	151101008	*
UNF 7/16 x 20	11,11	8,0	100	22	6,2	10,55	151101009	*
UNF 1/2 x 20	12,70	9,0	100	22	7,0	12,15	151101010	*
UNF 5/8 x 18	15,88	12,0	100	22	9,0	15,25	151101011	*
UNF 3/4 x 16	19,05	14,0	110	25	11,0	18,35	151101012	*

* on request

UNF

Unified fine thread / ANSI B1.1

Efficient internal thread cutting with battery powered screwdriver (min. 7,5 Volt).

Core hole drilling and thread tapping in one fluent process.

Application:

- non abrasive material up to 600 N/mm²
- unalloyed and low alloyed steel

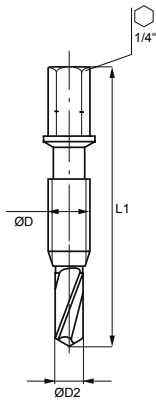

Kombi-Bit-Taps for through holes

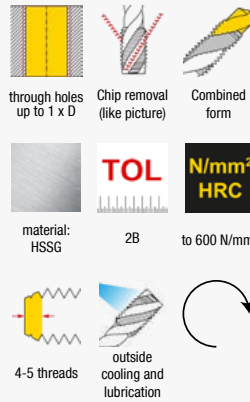

UNF	D1	D2	L1		No.	€
UNF No 4 x 48	2,85	2,4	36	1/4"	151301001	*
UNF No 5 x 44	3,18	2,7	36	1/4"	151301002	*
UNF No 6 x 40	3,51	3,0	39	1/4"	151301003	*
UNF No 8 x 36	4,17	3,5	39	1/4"	151301004	*
UNF No 10 x 32	4,83	4,1	41	1/4"	151301005	*
UNF No 12 x 28	5,49	4,7	41	1/4"	151301006	*
UNF 1/4 x 28	6,35	5,5	44	1/4"	151301007	*
UNF 5/16 x 24	7,94	6,9	50	1/4"	151301008	*
UNF 3/8 x 24	9,53	8,5	59	1/4"	151301009	*

* on request

Round Dies for general use

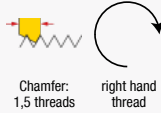

material: HSS 2A

 Chamfer: 1,5 threads
right hand thread

Round Dies for general use Left Hand

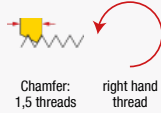

material: HSS 2A

 Chamfer: 1,5 threads
right hand thread

Round Dies for stainless steels

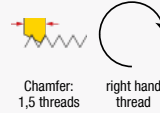

material: HSSE 2A

 Chamfer: 1,5 threads
right hand thread

with spiral entry

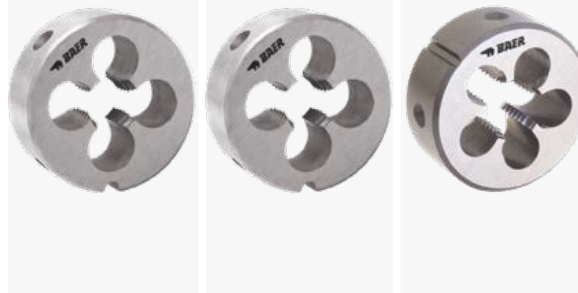
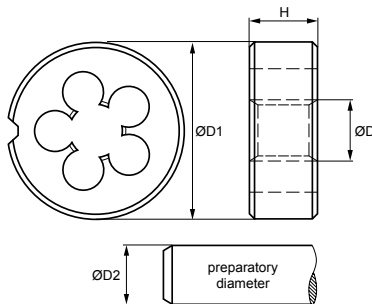

UNF

	D	D1	H	D2	No.	€	No.	€	No.	€
UNF NR. 0 x 80	1,52	16	5	1,47	151401001	21,00				
UNF NR. 1 x 72	1,85	16	5	1,79	151401002	21,00				
UNF NR. 2 x 64	2,18	16	5	2,12	151401003	16,75				
UNF NR. 3 x 56	2,52	16	5	2,44	151401004	16,75				
UNF NR. 4 x 48	2,85	20	5	2,77	151401005	13,86				
UNF NR. 5 x 44	3,18	20	5	3,10	151401006	13,86				
UNF NR. 6 x 40	3,51	20	5	3,42	151401007	12,92				
UNF NR. 8 x 36	4,17	20	7	4,08	151401008	12,92				
UNF NR. 10 x 32	4,83	20	7	4,73	151401009	12,92	151402001	23,38	151405001	79,16
UNF NR. 12 x 28	5,49	20	7	5,38	151401010	12,92				
UNF 1/4 x 28	6,35	20	7	6,24	151401011	12,27	151402002	18,94	151405002	95,35
UNF 5/16 x 24	7,94	25	9	7,82	151401012	14,03	151402003	22,10	151405003	98,86
UNF 3/8 x 24	9,53	30	11	9,41	151401013	15,56	151402004	26,90	151405004	121,92
UNF 7/16 x 20	11,11	30	11	10,98	151401014	18,01	151402005	26,90	151405005	117,57
UNF 1/2 x 20	12,70	38	10	12,56	151401015	20,23	151402006	42,09		
UNF 9/16 x 18	14,29	38	10	14,14	151401016	25,03	151402007	42,09		
UNF 5/8 x 18	15,88	45	14	15,73	151401017	27,36	151402008	53,80		
UNF 3/4 x 16	19,05	45	14	18,89	151401018	27,36	151402009	53,80		
UNF 7/8 x 14	22,23	55	16	22,05	151401019	46,77	151402010	78,35		
UNF 1" x 12	25,40	55	16	25,21	151401020	46,77	151402011	78,35		
UNF 1" x 14	25,40	55	16	25,23	151401021	46,77				
UNF 1.1/8 x 12	28,58	65	18	28,38	151401022	70,76				
UNF 1.1/4 x 12	31,75	65	18	31,55	151401023	70,76				
UNF 1.3/8 x 12	34,93	65	18	34,73	151401024	70,76				
UNF 1.1/2 x 12	38,10	65	18	37,90	151401025	70,76				
UNF 1.1/2 x 12	38,10	75	20	37,90	151401026	126,30				

Hexagon Die Nuts for general use

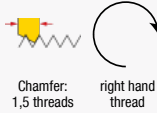

material: HSS TOL 2A

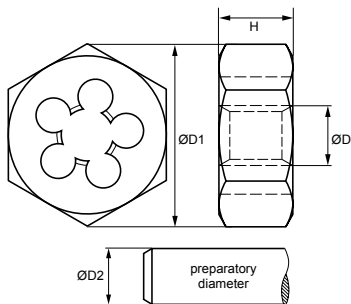

Chamfer: 1,5 threads right hand thread

UNF

	D	D1	H	D2	No.	€
UNF 1/4 x 28	6,35	19	7	6,24	151501001	15,20
UNF 5/16 x 24	7,94	22	9	7,82	151501002	15,78
UNF 3/8 x 24	9,53	27	11	9,41	151501003	19,07
UNF 7/16 x 20	11,11	27	11	10,98	151501004	19,07
UNF 1/2 x 20	12,70	36	10	12,56	151501005	23,38
UNF 9/16 x 18	14,29	36	10	14,14	151501006	23,38
UNF 5/8 x 18	15,88	41	14	15,73	151501007	31,93
UNF 3/4 x 16	19,05	41	14	18,89	151501008	31,93
UNF 7/8 x 14	22,23	50	16	22,05	151501009	66,32
UNF 1" x 12	25,40	50	16	25,21	151501010	66,32
UNF 1.1/8 x 12	28,58	60	18	28,38	151501011	100,58
UNF 1.1/4 x 12	31,75	60	18	31,55	151501012	100,58
UNF 1.3/8 x 12	34,93	60	18	34,73	151501013	100,58
UNF 1.1/2 x 12	38,10	70	20	37,90	151501014	120,46

UNS

Unified thread with special / threads per inch (TPI)

- ✓ Tap for machine use in through hole and blind hole.
- ✓ The short lead-in chamfer makes that tap universal in application. The flutes can hold the most part of the chips.

Machine Taps

Form C for through holes and blind holes

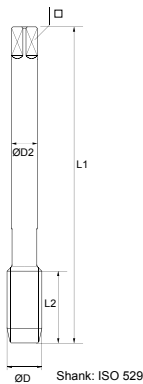
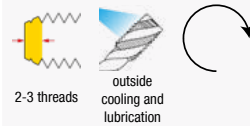
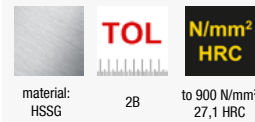
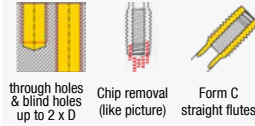

Round Dies

for general use

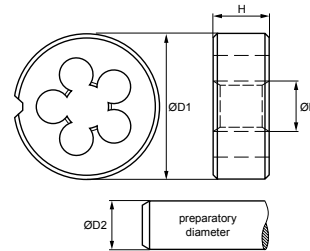
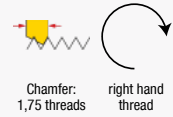

UNS	D1	D2	L1	L2	□	Image	No.	€
UNS 1/4 x 24	6,35	6,3	66	19	5,0	Image	160501001	9,97
UNS 1/4 x 36	6,35	6,3	66	19	5,0	Image	160501002	9,97
UNS 1/4 x 40	6,35	6,3	66	19	5,0	Image	160501003	9,97
UNS 3/8 x 27	9,53	10,0	80	24	8,0	Image	160501004	14,27
UNS 7/16 x 24	11,11	8,0	85	25	6,3	Image	160501005	16,79
UNS 1/2 x 24	12,70	9,0	89	29	7,1	Image	160501006	16,79
UNS 5/8 x 27	15,88	12,5	102	32	10,0	Image	160501007	25,71
UNS 3/4 x 24	19,05	14,0	112	37	11,2	Image	160501008	47,65
UNS 7/8 x 18	22,23	16,0	118	38	12,5	Image	160501009	58,14
UNS 1" x 14	25,40	18,0	130	45	14,0	Image	160501010	66,75

UNS	D	D1	H	D2	No.	€
UNS 1/4 x 24	6,35	20	7	6,24	161401001	39,69
UNS 1/4 x 36	6,35	20	5	6,26	161401002	39,69
UNS 1/4 x 40	6,35	20	5	6,27	161401003	39,69
UNS 3/8 x 27	9,53	30	11	9,41	161401004	*
UNS 7/16 x 24	11,11	30	11	11,00	161401005	65,60
UNS 1/2 x 24	12,70	38	10	12,59	161401006	66,71
UNS 5/8 x 27	15,88	45	14	15,76	161401007	110,03
UNS 7/8 x 18	22,23	55	16	22,08	161401008	203,96
UNS 1" x 14	25,40	55	16	25,23	161401009	203,96

* on request

UNEF Unified extra fine thread / ANSI B1.1

Efficient internal thread cutting.

The short structural type of the Hand Tap Sets makes that tap usable by hand. The Short-Machine-Tap is also usable by machine.

A Hand-Tap-Set includes 2 taps:

- Taper Tap
- Finish Tap

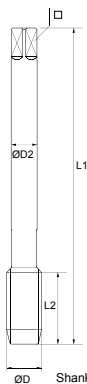

Shank: ISO 529

Hand Tap Sets for general use

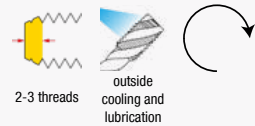
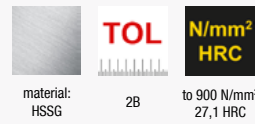
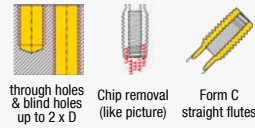

Machine Taps Form C for through holes and blind holes

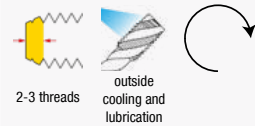
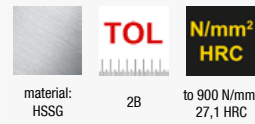
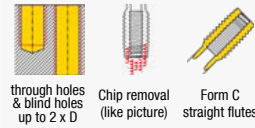

UNEF

	D1	D2	L1	L2	□		No.	€	No.	€
UNEF No 12 x 32	5,49	5,6	62	17	4,5	4,75			170501001	11,12
UNEF 1/4 x 32	6,35	6,3	66	19	5,0	5,60	170313001	16,84	170501002	9,97
UNEF 5/16 x 32	7,94	8,0	72	22	6,3	7,20	170313002	18,94	170501003	12,49
UNEF 3/8 x 32	9,53	10,0	80	24	8,0	8,80	170313003	18,96	170501004	14,27
UNEF 7/16 x 28	11,11	8,0	85	25	6,3	10,25	170313004	26,66	170501005	16,79
UNEF 1/2 x 28	12,70	9,0	89	29	7,1	11,80	170313005	31,57	170501006	16,79
UNEF 9/16 x 24	14,29	11,2	95	30	9,0	13,30	170313006	44,21	170501007	25,19
UNEF 5/8 x 24	15,88	12,5	102	32	10,0	14,90	170313007	49,82	170501008	25,71
UNEF 11/16 x 24	17,46	14,0	112	37	11,2	16,50			170501009	47,65
UNEF 3/4 x 20	19,05	14,0	112	37	11,2	17,75	170313008	66,66	170501010	47,65
UNEF 13/16 x 20	20,64	16,0	118	38	12,5	19,50			170501011	58,14
UNEF 7/8 x 20	22,23	16,0	118	38	12,5	21,00	170313009	89,47	170501012	58,14
UNEF 15/16 x 20	23,81	18,0	130	45	14,0	22,50			170501013	66,75
UNEF 1" x 20	25,40	16,0	130	45	14,0	24,25	170313010	102,44	170501014	66,75
UNEF 1.1/16 x 18	26,99	20,0	138	48	16,0	25,70			170501015	76,82
UNEF 1.1/8 x 18	28,58	20,0	138	48	16,0	27,25			170501016	76,82
UNEF 1.3/16 x 18	30,16	22,4	151	51	18,0	28,75			170501017	90,04
UNEF 1.1/4 x 18	31,75	22,4	151	51	18,0	30,50			170501018	90,04
UNEF 1.5/16 x 18	33,34	25,0	162	57	20,0	32,00			170501019	113,34
UNEF 1.3/8 x 18	34,93	25,0	162	57	20,0	33,50			170501020	113,34
UNEF 1.7/16 x 18	36,51	28,0	170	60	22,4	35,20			170501021	146,09
UNEF 1.1/2 x 18	38,10	28,0	170	60	22,4	36,80			170501022	146,09
UNEF 1.9/16 x 18	39,69	28,0	170	60	22,4	38,40			170501023	172,53
UNEF 1.5/8 x 18	41,28	28,0	170	60	22,4	40,00			170501024	172,53
UNEF 1.11/16 x 18	42,86	31,5	187	67	25,0	41,50			170501025	199,40
UNEF 1.3/4 x 18	44,45	31,5	187	67	25,0	43,00			170501026	199,40
UNEF 2" x 18	50,80	35,5	200	70	28,0	49,50			170501027	304,77

Round Dies for general use

 material:
HSS

2A

 Chamfer:
1,5 threads

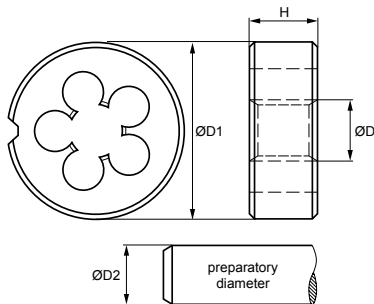
 right hand
thread

UNEF

	D	D1	H	D2	No.	€
UNEF No 12 x 32	5,49	20	7	5,39	171401001	14,59
UNEF 1/4 x 32	6,35	20	7	6,25	171401002	14,59
UNEF 5/16 x 32	7,94	25	9	7,84	171401003	18,58
UNEF 3/8 x 32	9,53	30	11	9,42	171401004	21,20
UNEF 7/16 x 28	11,11	30	11	11,00	171401005	21,20
UNEF 1/2 x 28	12,70	38	10	12,59	171401006	32,43
UNEF 9/16 x 24	14,29	38	10	14,17	171401007	32,43
UNEF 5/8 x 24	15,88	45	14	15,75	171401008	51,84
UNEF 11/16 x 24	17,46	45	14	17,33	171401009	51,84
UNEF 3/4 x 20	19,05	45	14	18,91	171401010	51,84
UNEF 13/16 x 20	20,64	55	16	20,50	171401011	61,18
UNEF 7/8 x 20	22,23	55	16	22,09	171401012	61,18
UNEF 15/16 x 20	23,81	55	16	23,67	171401013	61,18
UNEF 1" x 20	25,40	55	16	25,26	171401014	61,18
UNEF 1.1/16 x 18	26,99	65	18	26,84	171401015	97,71
UNEF 1.1/8 x 18	28,58	65	18	28,58	171401016	97,71
UNEF 1.3/16 x 18	30,23	65	18	30,16	171401017	97,71
UNEF 1.1/4 x 18	31,75	65	18	31,75	171401018	97,71
UNEF 1.5/16 x 18	33,34	65	18	33,34	171401019	97,71
UNEF 1.3/8 x 18	34,93	65	18	34,93	171401020	97,71
UNEF 1.7/16 x 18	36,51	75	20	36,51	171401021	123,52
UNEF 1.1/2 x 18	38,10	75	20	38,10	171401022	123,52

8-UN Unified thread series with 8-threads per inch (TPI)

Efficient internal thread cutting.

The short structural type of the Hand Tap Sets makes that tap usable by hand. The Short-Machine-Tap is also usable by machine.

A Hand-Tap-Set includes 2 taps:

- Taper Tap
- Finish Tap

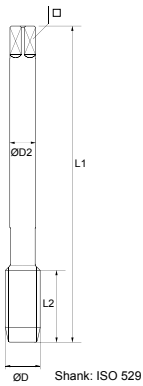

Hand Tap Sets for general use

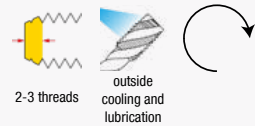
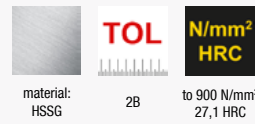
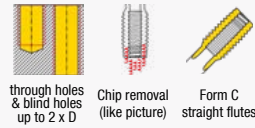

Machine Taps Form C for through holes and blind holes

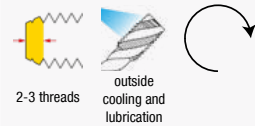
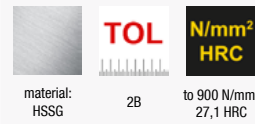
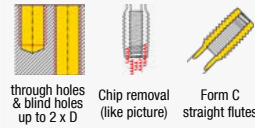

8-UN	D1	D2	L1	L2	□		No.	€	No.	€
UN 1.1/16 x 8	26,99	20,0	138	48	16,0	23,90	180301001	352,80	180501001	76,82
UN 1.1/8 x 8	28,58	20,0	138	48	16,0	25,50	180301002	135,79	180501002	76,82
UN 1.3/16 x 8	30,16	22,4	151	51	18,0	27,10	180301003	389,84	180501003	89,94
UN 1.1/4 x 8	31,75	22,4	151	51	18,0	28,75	180301004	159,47	180501004	89,94
UN 1.5/16 x 8	33,34	25,0	162	57	20,0	30,30	180301005	413,44	180501005	113,34
UN 1.3/8 x 8	34,93	25,0	162	57	20,0	31,75	180301006	192,63	180501006	113,34
UN 1.1/2 x 8	38,10	28,0	170	60	22,4	35,00	180301007	243,16	180501007	146,09
UN 1.5/8 x 8	41,28	28,0	170	60	22,4	38,00	180301008	445,26	180501008	172,53
UN 1.3/4 x 8	44,45	31,5	187	67	25,0	41,50	180301009	445,26	180501009	201,50
UN 1.7/8 x 8	47,63	31,5	187	67	25,0	44,50	180301010	587,37	180501010	304,77
UN 2" x 8	50,80	35,5	200	70	28,0	47,75	180301011	587,37	180501011	304,77
UN 2.1/8 x 8	53,98	35,5	200	70	28,0	50,90	180301012	1.174,74	180501012	604,50
UN 2.1/4 x 8	57,15	40,0	221	76	31,5	54,00	180301013	461,05	180501013	604,50
UN 2.1/2 x 8	63,50	40,0	224	79	31,5	60,40	180301014	1.402,11	180501014	881,56
UN 2.3/4 x 8	69,85	45,0	234	79	35,5	66,70	180301015	1.724,21	180501015	969,71
UN 3" x 8	76,20	50,0	258	83	40,0	73,10	180301016	3.221,05	180501016	1.089,35
UN 3.1/4 x 8	82,55	50,0	261	86	40,0	79,40	180301017	4.583,09	180501017	1.089,35
UN 3.1/2 x 8	88,90	50,0	261	86	40,0	85,80	180301018	3.746,62	180501018	1.284,56
UN 3.3/4 x 8	95,25	56,0	279	89	45,0	92,10	180301019	7.891,70	180501019	1.574,21
UN 4" x 8	101,60	56,0	279	89	45,0	98,50	180301020	4.722,63	180501020	1.574,21

* on request

8-UN

Unified thread series with 8-threads per inch (TPI)

Round Dies for general use



material: HSS 2A



Chamfer: 1,75 threads
right hand thread

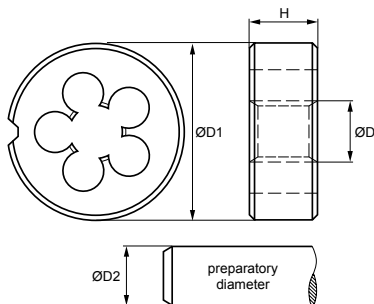

Hexagon Die Nuts for general use



material: HSS medium



Chamfer: 1,5 threads
right hand thread

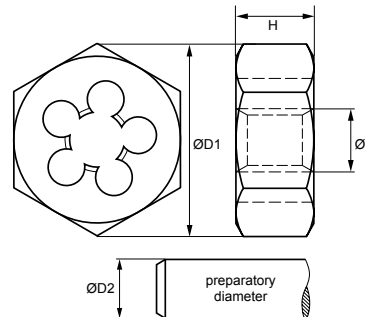

8-UN

	D	D1	H	D2	No.	€
UN 1.1/8 x 8	28,58	65	25	28,33	181401001	254,13
UN 1.1/4 x 8	31,75	65	25	31,51	181401002	310,91
UN 1.3/8 x 8	34,93	65	25	34,68	181401003	286,65
UN 1.1/2 x 8	38,10	75	20	37,85	181401004	400,21
UN 1.3/4 x 8	44,45	90	22	44,20	181401005	595,35
UN 2" x 8	50,80	90	22	50,55	181401006	622,91

8-UN

	D	D1	H	D2	No.	€
UN 1.1/8 x 8	28,58	60	25	28,33	181501001	100,70
UN 1.1/4 x 8	31,75	60	25	31,51	181501002	100,70
UN 1.3/8 x 8	34,93	60	25	34,68	181501003	100,70
UN 1.1/2 x 8	38,10	60	25	37,85	181501004	182,96
UN 1.5/8 x 8	41,28	70	30	41,03	181501005	182,96
UN 1.3/4 x 8	44,45	85	36	44,20	181501006	182,96
UN 1.7/8 x 8	47,63	85	22	47,38	181501007	182,96
UN 2" x 8	50,80	85	22	50,55	181501008	182,96
UN 2.1/8 x 8	53,98	85	22		181501009	311,89
UN 2.1/4 x 8	57,15	100	22		181501010	311,89
UN 2.1/2 x 8	63,50	115	22		181501011	466,60

12-UN

Unified thread series with 12-threads per inch (TPI)

Efficient internal thread cutting.

The short structural type makes that tap usable by hand. The Short-Machine-Tap is also usable by machine.

A Hand-Tap-Set includes 2-3 taps:

- Taper Tap (Intermediate Tap)
- Finish Tap

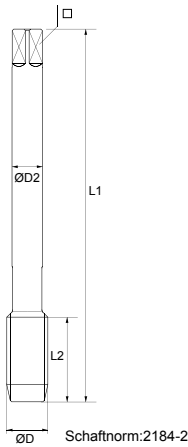

Hand Tap Sets for general use

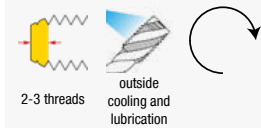
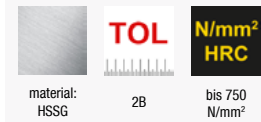
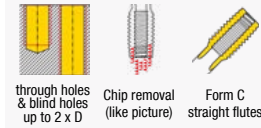

Machine Taps Form C for through holes and blind holes

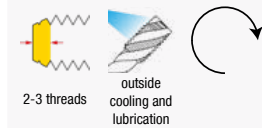
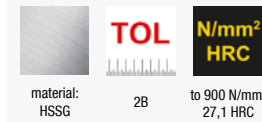
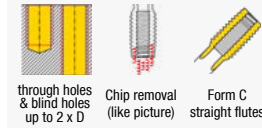

12-UN

	D1	D2	L1	L2	□		No.	€	No.	€
UN 1/2 x 12	12,70	9,0	75	25	7,0	10,65	190301001	314,21		
UN 5/8 x 12	15,88	12,0	80	25	9,0	13,80	190301002	374,85		
UN 11/16 x 12	17,46	14,0	80	25	11,0	15,40	190301003	418,95		
UN 3/4 x 12	19,05	14,0	80	25	11,0	17,00	190301004	463,05		
UN 13/16 x 12	20,64	16,0	80	25	12,0	18,60	190301005	474,08		
UN 7/8 x 12	22,23	18,0	80	25	14,5	20,20	190301006	475,18		
UN 15/16 x 12	23,81	18,0	90	25	14,5	21,80	190301007	475,18		
UN 1.1/16 x 12	26,99	20,0	90	28	16,0	24,90	190301008	497,23		
UN 1.3/16 x 12	30,16	22,0	90	28	18,0	28,10	190301009	577,71		
UN 1.5/16 x 12	33,34	28,0	125	32	22,0	31,30	190301010	614,09		
UN 1.7/16 x 12	36,51	28,0	125	32	22,0	34,50	190301011	800,42		
UN 1.5/8 x 12	41,28	32,0	125	32	24,0	39,20	190301012	1.025,33	190501001	214,09
UN 1.3/4 x 12	44,45	36,0	125	32	29,0	42,40	190301013	1.025,33	190501002	249,77
UN 1.7/8 x 12	47,63	36,0	140	32	29,0	45,60	190301014	1.168,65	190501003	384,11
UN 2 x 12	50,80	40,0	140	32	32,0	48,75	190301015	1.422,23	190501004	384,11
UN 2.1/8 x 12	53,98	35,5	200	70	28,0	51,90			190501005	758,77
UN 2.1/4 x 12	57,15	40,0	221	76	31,5	55,10			190501006	758,77
UN 2.1/2 x 12	63,50	40,0	224	79	31,5	61,50			190501007	1.101,95
UN 2.3/4 x 12	69,85	45,0	234	79	35,5	67,80			190501008	1.221,59
UN 3" x 12	76,20	50,0	258	83	40,0	74,20			190501009	1.360,12
UN 3.1/4 x 12	82,55	50,0	261	86	40,0	80,50			190501010	1.360,12
UN 3.1/2 x 12	88,90	50,0	261	86	40,0	86,90			190501011	1.586,80
UN 3.3/4 x 12	95,25	56,0	279	89	45,0	93,20			190501012	1.989,80
UN 4" x 12	101,60	56,0	279	89	45,0	99,60			190501013	1.989,80

* on request

12-UN

Unified thread series with 12-threads per inch (TPI)

Round Dies for general use

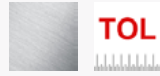

material: HSS medium



Chamfer: 1,75 threads right hand thread

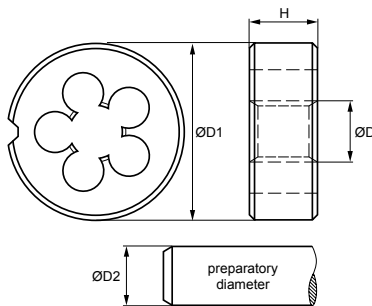

12-UN

	D	D1	H	D2	No.	€
UN 1.1/16 x 12	26,99	65	18	26,80	191401001	334,78
UN 1.5/16 x 12	33,34	65	18	33,15	191401002	288,61
UN 1.5/8 x 12	41,28	75	20	41,09	191401003	503,75
UN 1.3/4 x 12	44,45	90	22	44,26	191401004	766,12
UN 2" x 12	50,80	90	22	50,61	191401005	1.920,54

BSW

British standard BS 84 whitworth coarse thread

BAER Hand-Tap Sets, Round Dies and Tools Sets (example picture)



BAER Set BSW 1/8" - 1/2"

HSSG Hand Tap Sets & HSS Round Dies & Tools

BAER HSSG Hand Tap Sets (3 parts)	BSW 1/8 x 40 BSW 3/16 x 24 BSW 1/4 x 20 BSW 5/16 x 18 BSW 3/8 x 16 BSW 7/16 x 14 BSW 1/2 x 12
BAER HSS Round Dies	BSW 1/8 x 40 BSW 3/16 x 24 BSW 1/4 x 20 BSW 5/16 x 18 BSW 3/8 x 16 BSW 7/16 x 14 BSW 1/2 x 12
BAER adjustable Tap Wrenches - zinc die cast	M 1-10 1/16-3/8 G 1/8 & M 4-12 5/32-1/2 G 1/8
BAER Die Stocks - zinc die cast	20 x 5 20 x 7 25 x 9 30 x 11 38 x 14

Screw extractor

334,11
€/Set

Item No.:
264803010

BAER Set BSW 1/4" - 1/2"

HSSG Hand Tap Sets & HSS Round Dies & Tools

BAER HSSG Hand Tap Sets (3 parts)	BSW 1/4 x 20 BSW 5/16 x 18 BSW 3/8 x 16 BSW 7/16 x 14 BSW 1/2 x 12
BAER HSS Round Dies	BSW 1/4 x 20 BSW 5/16 x 18 BSW 3/8 x 16 BSW 7/16 x 14 BSW 1/2 x 12
BAER adjustable Tap Wrenches - zinc die cast	M 1-10 1/16-3/8 G 1/8 & M 4-12 5/32-1/2 G 1/8
BAER Die Stocks - zinc die cast	20 x 7 25 x 9 30 x 11 38 x 14

Screw extractor

288,03
€/Set

Item No.:
264803110

BAER Set BSW 1/4" - 3/4"

HSSG Hand Tap Sets & HSS Round Dies & Tools

BAER HSSG Hand Tap Sets (3 parts)	BSW 1/4 x 20 BSW 5/16 x 18 BSW 3/8 x 16 BSW 7/16 x 14 BSW 1/2 x 12 BSW 5/8 x 11 BSW 3/4 x 10
BAER HSS Round Dies	BSW 1/4 x 20 BSW 5/16 x 18 BSW 3/8 x 16 BSW 7/16 x 14 BSW 1/2 x 12 BSW 5/8 x 11 BSW 3/4 x 10
BAER adjustable Tap Wrenches - zinc die cast	M 1-10 1/16-3/8 G 1/8 & M 5-20 7/32-3/4" G 1/8-1/2
BAER Die Stocks - zinc die cast	20 x 7 25 x 9 30 x 11 38 x 14 45 x 18

Screw extractor

502,74
€/Set

Item No.:
264803210

BAER Set BSW 1/4" - 1"

HSSG Hand Tap Sets & HSS Round Dies & Tools

BAER HSSG Hand Tap Sets (3 parts)	BSW 1/4 x 20 BSW 5/16 x 18 BSW 3/8 x 16 BSW 7/16 x 14 BSW 1/2 x 12 BSW 5/8 x 11 BSW 3/4 x 10 BSW 7/8 x 9 BSW 1" x 8
BAER HSS Round Dies	BSW 1/4 x 20 BSW 5/16 x 18 BSW 3/8 x 16 BSW 7/16 x 14 BSW 1/2 x 12 BSW 5/8 x 11 BSW 3/4 x 10 BSW 7/8 x 9 BSW 1" x 8
BAER adjustable Tap Wrenches - zinc die cast	M 1-10 1/16-3/8 G 1/8 & M 11-27 7/16-1" G 1/4-3/4
BAER Die Stocks - zinc die cast	20 x 7 25 x 9 30 x 11 38 x 14 45 x 18 55 x 22

Screw extractor

764,58
€/Set

Item No.:
264803410

BAER Set BSW 1/4" - 1.1/2"

HSSG Hand Tap Sets & HSS Round Dies & Tools

BAER HSSG Hand Tap Sets (3 parts)	BSW 1/4 x 20 BSW 5/16 x 18 BSW 3/8 x 16 BSW 7/16 x 14 BSW 1/2 x 12 BSW 5/8 x 11 BSW 3/4 x 10 BSW 7/8 x 9 BSW 1" x 8 BSW 1.1/8" x 7 BSW 1.1/4" x 7 BSW 1.3/8" x 6 BSW 1.1/2" x 6
BAER HSS Round Dies	BSW 1/4 x 20 BSW 5/16 x 18 BSW 3/8 x 16 BSW 7/16 x 14 BSW 1/2 x 12 BSW 5/8 x 11 BSW 3/4 x 10 BSW 7/8 x 9 BSW 1" x 8 BSW 1.1/8" x 7 BSW 1.1/4" x 7 BSW 1.3/8" x 6 BSW 1.1/2" x 6
BAER adjustable Tap Wrenches - zinc die cast	M 1-10 1/16-3/8 G 1/8 & M 5-20 7/32-3/4 G 1/8-1/2 & M 13-32 1/2-1.1/4" G 1/4-1"
BAER Die Stocks - zinc die cast	20 x 7 25 x 9 30 x 11 38 x 14 45 x 18 55 x 22 65 x 25

Screw extractor

1.916,68
€/Set

Item No.:
264803510

BSW

British standard BS 84 whitworth coarse thread

BAER Short Machine Taps und Round Dies Sets BSW 1/4" - 1/2" (example picture)



BAER Set BSW 1/4" - 1/2" HSSG Short Machine Taps & Drill bits for core holes HSS Round Dies

175,24
€/Set

Item No.:
BES4

BAER HSSG Short Machine Tap Form D for through hole & blind hole (up to 4 x D)	BSW 1/4 x 20 BSW 5/16 x 18 BSW 3/8 x 16 BSW 7/16 x 14 BSW 1/2 x 12
BAER HSSG Drill bits for core holes	5,1 mm 6,5 mm 7,9 mm 9,3 mm 10,5 mm
BAER HSS Round Dies	BSW 1/4 x 20 BSW 5/16 x 18 BSW 3/8 x 16 BSW 7/16 x 14 BSW 1/2 x 12

BSW

British standard BS 84 whitworth coarse thread

Efficient internal thread cutting.

The short structural type makes that tap usable by hand. The Short-Machine-Tap is also usable by machine.

A Hand-Tap-Set includes 3 taps:

- Taper Tap
- Intermediate Tap
- Finish Tap

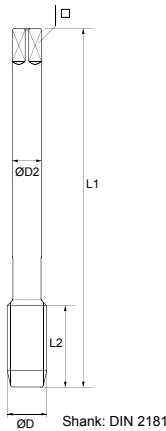

Short Machine Taps Form D for through holes and blind holes

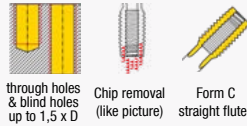

through holes & blind holes up to 1,5 x D
Chip removal (like picture)
Form C straight flutes

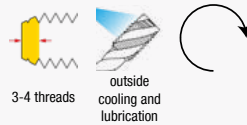

Hand Tap Sets for general use

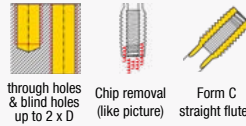

through holes & blind holes up to 2 x D
Chip removal (like picture)
Form C straight flutes

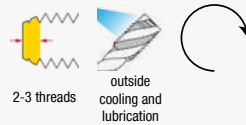

Hand Tap Sets for general use Left Hand

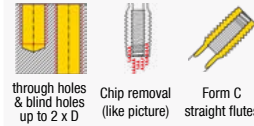

through holes & blind holes up to 2 x D
Chip removal (like picture)
Form C straight flutes

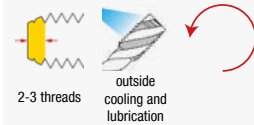

BSW	D1	D2	L1	L2			No.	€	No.	€	No.	€
BSW 1/16 x 60	1,59	2,5	36	10	2,1	1,20	210101001	10,77	210301001	20,78		
BSW 3/32 x 48	2,38	2,8	36	10	2,1	1,90	210101002	8,69	210301002	16,06		
BSW 1/8 x 40	3,18	3,5	40	12	2,7	2,60	210101003	7,75	210301003	14,48	210302001	24,21
BSW 5/32 x 32	3,97	4,5	45	14	3,4	3,20	210101004	7,75	210301004	14,48	210302002	24,21
BSW 3/16 x 24	4,76	6,0	50	18	4,9	3,80	210101005	7,56	210301005	14,17	210302003	24,21
BSW 7/32 x 24	5,56	6,0	50	18	4,9	4,60	210101006	7,56	210301006	14,17		
BSW 1/4 x 20	6,35	6,0	50	19	4,9	5,10	210101007	7,56	210301007	14,17	210302004	24,21
BSW 5/16 x 18	7,94	6,0	56	22	4,9	6,50	210101008	8,51	210301008	15,74	210302005	25,26
BSW 3/8 x 16	9,53	7,0	70	24	5,5	7,90	210101009	9,44	210301009	17,63	210302006	29,47
BSW 7/16 x 14	11,11	8,0	70	24	6,2	9,30	210101010	11,90	210301010	22,35	210302007	36,14
BSW 1/2 x 12	12,70	9,0	75	29	7,0	10,50	210101011	14,35	210301011	27,08	210302008	43,16
BSW 9/16 x 12	14,29	11,0	80	30	9,0	12,00	210101012	18,89	210301012	35,26	210302009	56,13
BSW 5/8 x 11	15,88	12,0	80	32	9,0	13,50	210101013	21,16	210301013	39,67	210302010	63,85
BSW 3/4 x 10	19,05	14,0	95	40	11,0	16,50	210101014	28,34	210301014	53,21	210302011	85,25
BSW 7/8 x 9	22,23	18,0	100	40	14,5	19,50	210101015	37,78	210301015	70,84	210302012	106,30
BSW 1" x 8	25,40	18,0	110	50	14,5	22,00	210101016	43,45	210301016	81,54	210302013	127,70
BSW 1.1/8 x 7	28,58	22,0	132	56	18,0	25,00	210101017	67,06	210301017	125,62		
BSW 1.1/4 x 7	31,75	22,0	132	56	18,0	28,00	210101018	75,57	210301018	141,36		
BSW 1.3/8 x 6	34,93	28,0	150	63	22,0	30,50	210101019	98,23	210301019	183,87		
BSW 1.1/2 x 6	38,10	32,0	150	63	24,0	33,50	210101020	113,35	210301020	212,20		
BSW 1.5/8 x 5	41,28	32,0	160	70	24,0	35,50	210101021	226,70	210301021	424,41		
BSW 1.3/4 x 5	44,45	36,0	160	70	29,0	39,00	210101022	226,70	210301022	424,41		
BSW 1.7/8 x 4,5	47,63	36,0	190	80	29,0	41,50	210101023	294,70	210301023	552,55		
BSW 2" x 4,5	50,80	40,0	190	80	32,0	44,50	210101024	294,70	210301024	552,55		
BSW 2.1/4 x 4	57,15	45,0	220	80	35,0	50,00	210101025	642,30	210301025	1.313,84		
BSW 2.1/2 x 4	63,50	50,0	220	80	39,0	56,50	210101026	821,75	210301026	1.751,78		
BSW 2.3/4 x 3,5	69,85	50,0	240	80	39,0	62,00	210101027	2.115,78	210301027	4.379,45		
BSW 3" x 3,5	76,20	50,0	260	80	39,0	68,00	210101028	2.720,29	210301028	5.390,10		

BSW

British standard BS 84 whitworth coarse thread

Tap for machine use in through hole and blind hole.

Machine Tap for general use in through hole



through holes up to 4 x D
Chip removal (like picture)
Form B with spiral point



material: HSSG
TOL medium
N/mm² HRC to 900 N/mm² 27,1 HRC

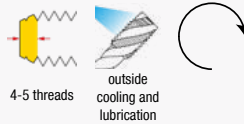

4-5 threads
outside cooling and lubrication



Machine Tap for general use in blind hole



blind holes up to 3 x D
Chip removal (like picture)
Form C 35° spiral flute



material: HSSE
TOL medium
N/mm² HRC to 900 N/mm² 27,1 HRC

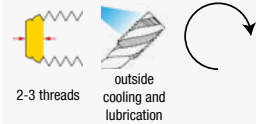

2-3 threads
outside cooling and lubrication

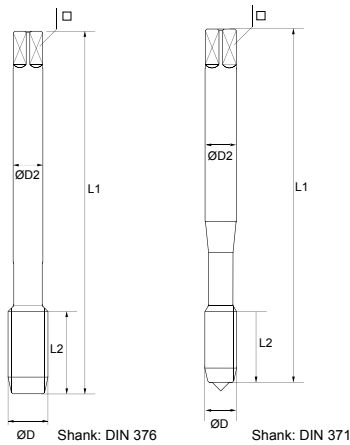

BSW

	D1	D2	L1	L2	□		No.	€	D1	D2	L1	L2	□	No.	€
DIN 371								DIN 371							
BSW 1/8 x 40	3,18	3,5	56	11	2,7	2,60	210401001	10,81	3,18	3,5	56	7	2,7	210601001	13,43
BSW 5/32 x 32	3,97	4,5	63	13	3,4	3,20	210401002	10,81	3,97	4,5	63	7	3,4	210601002	13,43
BSW 3/16 x 24	4,76	6,0	70	15	4,9	3,80	210401003	10,81	4,76	6,0	70	10	4,9	210601003	13,43
BSW 1/4 x 20	6,35	7,0	80	17	5,5	5,10	210401004	10,81	6,35	7,0	80	13	5,5	210601004	13,43
BSW 5/16 x 18	7,94	8,0	90	20	6,2	6,50	210401005	13,75	7,94	8,0	90	14	6,2	210601005	16,90
BSW 3/8 x 16	9,53	9,0	100	22	7,0	7,90	210401006	15,32	9,53	9,0	100	16	7,0	210601006	18,47
BSW 7/16 x 14	11,11	11,0	100	22	9,0	9,30	210401007	18,26	11,11	11,0	100	17	9,0	210601007	22,77
BSW 1/2 x 12	12,70	12,0	110	25	9,0	10,50	210401008	18,26	12,70	12,0	110	20	9,0	210601008	22,77
DIN 376								DIN 376							
BSW 1/4 x 20	6,35	4,5	80	17	3,4	5,10	210401009	10,81	6,35	4,5	80	13	3,4	210601009	13,43
BSW 5/16 x 18	7,94	6,0	90	20	4,9	6,50	210401010	13,75	7,94	6,0	90	14	4,9	210601010	16,90
BSW 3/8 x 16	9,53	7,0	100	22	5,5	7,90	210401011	15,32	9,53	7,0	100	16	5,5	210601011	18,47
BSW 7/16 x 14	11,11	8,0	100	22	6,2	9,30	210401012	18,26	11,11	8,0	100	17	6,2	210601012	22,77
BSW 1/2 x 12	12,70	9,0	110	25	7,0	10,50	210401013	18,26	12,70	9,0	110	20	7,0	210601013	22,77
BSW 9/16 x 12	14,29	11,0	110	26	9,0	12,00	210401014	27,81	14,29	11,0	110	20	9,0	210601014	33,58
BSW 5/8 x 11	15,88	12,0	110	27	9,0	13,50	210401015	27,81	15,88	12,0	110	22	9,0	210601015	33,58
BSW 3/4 x 10	19,05	14,0	125	30	11,0	16,50	210401016	54,15	19,05	14,0	125	25	11,0	210601016	66,96
BSW 7/8 x 9	22,23	18,0	140	32	14,5	19,50	210401017	65,49	22,23	18,0	140	27	14,5	210601017	81,86
BSW 1" x 8	25,40	20,0	160	36	16,0	22,00	210401018	74,30	25,40	20,0	160	30	16,0	210601018	91,93
BSW 1.1/4 x 7	31,75	22,0	180	40	18,0	28,00	210401019	103,90	31,75	22,0	180	35	18,0	210601019	117,12
BSW 1.3/8 x 6	34,93	28,0	200	50	22,0	30,50	210401020	216,61	34,93	28,0	200	40	22,0	210601020	255,65
BSW 1.1/2 x 6	38,10	32,0	200	50	24,0	33,50	210401021	216,61	38,10	32,0	200	40	24,0	210601021	255,65

Round Dies for general use

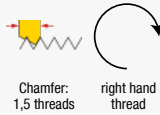
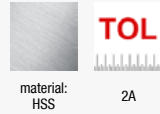

Round Dies for general use Left Hand

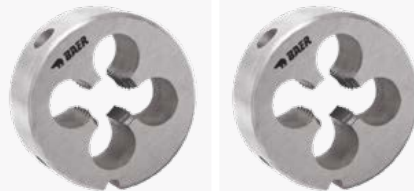
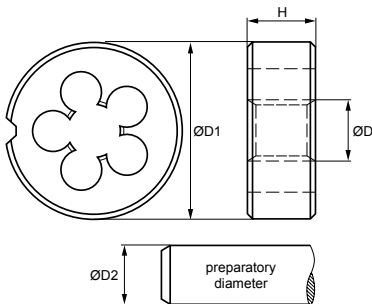
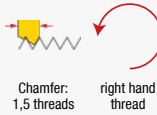
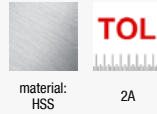
BSW

	D	D1	H	D2	No.	€	No.	€
BSW 1/16 x 60	1,59	16	5	1,51	211401001	12,27		
BSW 3/32 x 48	2,38	16	5	2,3	211401002	12,27		
BSW 1/8 x 40	3,18	20	5	3,09	211401003	12,27	211402001	18,94
BSW 5/32 x 32	3,97	20	5	3,88	211401004	12,27	211402002	18,94
BSW 3/16 x 24	4,76	20	7	4,66	211401005	12,27	211402003	18,94
BSW 7/32 x 24	5,56	20	7	5,46	211401006	12,27		
BSW 1/4 x 20	6,35	20	7	6,24	211401007	12,27	211402004	18,94
BSW 5/16 x 18	7,94	25	9	7,82	211401008	14,03	211402005	22,1
BSW 3/8 x 16	9,53	30	11	9,4	211401009	15,56	211402006	26,9
BSW 7/16 x 14	11,11	30	11	10,98	211401010	18,01	211402007	26,9
BSW 1/2 x 12	12,7	38	14	12,56	211401011	20,23	211402008	42,09
BSW 9/16 x 12	14,29	38	14	14,14	211401012	25,03	211402009	42,09
BSW 5/8 x 11	15,88	45	18	15,72	211401013	27,36	211402010	53,8
BSW 3/4 x 10	19,05	45	18	18,89	211401014	27,36	211402011	53,8
BSW 7/8 x 9	22,23	55	22	22,1	211401015	46,77	211402012	78,35
BSW 1" x 8	25,4	55	22	25,27	211401016	46,77	211402013	78,35
BSW 1.1/8 x 7	28,58	65	25	28,44	211401017	70,76		
BSW 1.1/4 x 7	31,75	65	25	31,61	211401018	70,76		
BSW 1.3/8 x 6	34,93	65	25	34,77	211401019	70,76		
BSW 1.1/2 x 6	38,1	65	25	37,95	211401020	70,76		
BSW 1.1/2 x 6	38,1	75	30	37,95	211401021	126,3		
BSW 1.5/8 x 5	41,28	75	30	41,11	211401022	126,3		
BSW 1.3/4 x 5	44,45	90	36	44,28	211401023	192,96		
BSW 1.7/8 x 4,5	47,63	90	36	47,46	211401024	192,96		
BSW 2" x 4,5	50,8	90	36	50,63	211401025	192,96		
BSW 2.1/4 x 4	57,15	105	36	56,98	211401026	535,23		
BSW 2.1/2 x 4	63,5	105	36	63,34	211401027	535,23		
BSW 2.3/4 x 3,5	69,85	120	36	69,68	211401028	656,13		
BSW 3" x 3,5	76,2	120	36	76,03	211401029	656,13		

Hexagon Die Nuts for general use

 material:
HSS

2A

 Chamfer:
1,5 threads

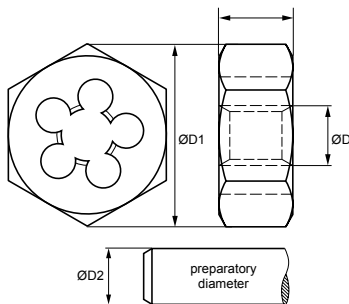
 right hand
thread

BSW

	D	D1	H	D2	No.	€
BSW 1/8 x 40	3,18	20	5	3,09	211501001	15,20
BSW 3/16 x 24	4,76	20	7	4,66	211501002	15,20
BSW 1/4 x 20	6,35	20	7	6,24	211501003	15,20
BSW 5/16 x 18	7,94	25	9	7,82	211501004	15,78
BSW 3/8 x 16	9,53	30	11	9,40	211501005	19,07
BSW 7/16 x 14	11,11	30	11	10,98	211501006	19,07
BSW 1/2 x 12	12,70	38	14	12,56	211501007	23,38
BSW 9/16 x 12	14,29	38	14	14,14	211501008	23,38
BSW 5/8 x 11	15,88	45	18	15,72	211501009	31,93
BSW 3/4 x 10	19,05	45	18	18,89	211501010	31,93
BSW 7/8 x 9	22,23	55	22	22,10	211501011	66,32
BSW 1" x 8	25,40	55	22	25,27	211501012	66,32
BSW 1.1/8 x 7	28,58	65	25	28,44	211501013	100,58
BSW 1.1/4 x 7	31,75	65	25	31,61	211501014	100,58
BSW 1.3/8 x 6	34,93	65	25	34,77	211501015	100,58
BSW 1.1/2 x 6	38,10	65	25	37,95	211501016	120,46
BSW 2" x 4,5	50,80	90	36	50,63	211501017	157,87
BSW 2.1/4 x 4	57,15	105	36	56,98	211501018	555,50
BSW 2.1/2 x 4	63,50	105	36	63,34	211501019	555,50
BSW 2.3/4 x 3,5	69,85	120	36	69,68	211501020	687,62
BSW 3" x 3,5	76,20	120	36	76,03	211501021	687,62

BSF

British standard BS 84 whitworth coarse thread

BAER Hand-Tap Sets, Round Dies and Tools Sets (example picture)



BAER Set BSF 1/4" - 1/2" HSSG Hand Tap Sets & HSS Round Dies & Tools

276,51
€/Set

BAER HSSG Hand Tap Sets (2 parts)	BSF 1/4 x 26 BSF 5/16 x 22 BSF 3/8 x 20 BSF 7/16 x 18 BSF 1/2 x 16
BAER HSS Round Dies	BSF 1/4 x 26 BSF 5/16 x 22 BSF 3/8 x 20 BSF 7/16 x 18 BSF 1/2 x 16
BAER adjustable Tap Wrenches - zinc die cast	M 1-10 1/16-3/8 G 1/8 & M 4-12 5/32-1/2 G 1/8
BAER Die Stocks - zinc die cast	20 x 7 25 x 9 30 x 11 38 x 10
Screw extractor	

Item No.:
264804111

BAER Set BSF 1/4" - 3/4" HSSG Hand Tap Sets & HSS Round Dies & Tools

472,36
€/Set

BAER HSSG Hand Tap Sets (2 parts)	BSF 1/4 x 26 BSF 5/16 x 22 BSF 3/8 x 20 BSF 7/16 x 18 BSF 1/2 x 16 BSF 5/8 x 14 BSF 3/4 x 12
BAER HSS Round Dies	BSF 1/4 x 26 BSF 5/16 x 22 BSF 3/8 x 20 BSF 7/16 x 18 BSF 1/2 x 16 BSF 5/8 x 14 BSF 3/4 x 12
BAER adjustable Tap Wrenches - zinc die cast	M 1-10 1/16-3/8 G 1/8 & M 5-20 7/32-3/4 G 1/8-1/2
BAER Die Stocks - zinc die cast	20 x 7 25 x 9 30 x 11 38 x 10 45 x 14
Screw extractor	

Item No.:
264804211

BAER Set BSF 1/4" - 1" HSSG Hand Tap Sets & HSS Round Dies & Tools

725,83
€/Set

BAER HSSG Hand Tap Sets (2 parts)	BSF 1/4 x 26 BSF 5/16 x 22 BSF 3/8 x 20 BSF 7/16 x 18 BSF 1/2 x 16 BSF 5/8 x 14 BSF 3/4 x 12 BSF 7/8 x 11 BSF 1" x 10
BAER HSS Round Dies	BSF 1/4 x 26 BSF 5/16 x 22 BSF 3/8 x 20 BSF 7/16 x 18 BSF 1/2 x 16 BSF 5/8 x 14 BSF 3/4 x 12 BSF 7/8 x 11 BSF 1" x 10
BAER adjustable Tap Wrenches - zinc die cast	M 1-10 1/16-3/8 G 1/8 & M 11-27 7/16-1" G 1/4-3/4
BAER Die Stocks - zinc die cast	20 x 7 25 x 9 30 x 11 38 x 10 45 x 14 55 x 16
Screw extractor	

Item No.:
264804411

BAER Set BSW & BSF 1/4" - 3/4" HSSG Hand Tap Sets & HSS Round Dies & Tools

806,47
€/Set

BAER HSSG Hand Tap Sets (3 parts) UNC	BSW 1/4 BSW 5/16 BSW 3/8 BSW 7/16 BSW 1/2 BSW 5/8 BSW 3/4
BAER HSSG Hand Tap Sets (2 parts) UNF	BSF 1/4 BSF 5/16 BSF 3/8 BSF 7/16 BSF 1/2 BSF 5/8 BSF 3/4
BAER HSS Round Dies UNC	BSW 1/4 BSW 5/16 BSW 3/8 BSW 7/16 BSW 1/2 BSW 5/8 BSW 3/4
BAER HSS Round Dies UNF	BSF 1/4 BSF 5/16 BSF 3/8 BSF 7/16 BSF 1/2 BSF 5/8 BSF 3/4
BAER adjustable Tap Wrenches - zinc die cast	M 1-10 1/16-3/8 G 1/8 & M 5-20 7/32-3/4" G 1/8-1/2
BAER Die Stocks - zinc die cast	20 x 7 25 x 9 30 x 11 38 x 14 45 x 18
Screw extractor	

Item No.:
2648046210

BSF

British standard BS 84 whitworth coarse thread

BAER Short Machine Taps und Round Dies Sets BSF 1/4" - 1/2" (example picture)



BAER Set BSF 1/4" - 1/2" HSSG Short Machine Taps & Drill bits for core holes HSS Round Dies

BAER HSSG Short Machine Tap Form D for through hole & blind hole (up to 4 x D)	BSF 1/4 x 26 BSF 5/16 x 22 BSF 3/8 x 20 BSF 7/16 x 18 BSF 1/2 x 16
BAER HSSG Drill bits for core holes	5,2 mm 6,6 mm 8,1 mm 9,5 mm 11 mm
BAER HSS Round Dies	BSF 1/4 x 26 BSF 5/16 x 22 BSF 3/8 x 20 BSF 7/16 x 18 BSF 1/2 x 16

176,62
€/Set

Item No.:
BES5

BSF

British standard BS 84 whitworth coarse thread

Efficient internal thread cutting.

The short structural type makes that tap usable by hand. The Short-Machine-Tap is also usable by machine.

A Hand-Tap-Set includes 2 taps:

- Taper Tap
- Finish Tap

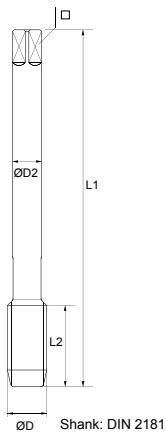

Short Machine Taps Form D for through holes and blind holes

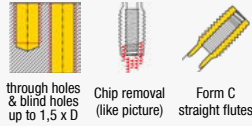

through holes & blind holes up to 1,5 x D
 Chip removal (like picture)
 Form C straight flutes
 material: HSSG medium to 900 N/mm² 27,1 HRC

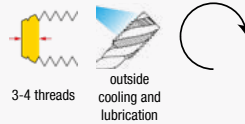

Hand Tap Sets for general use

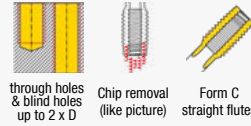

through holes & blind holes up to 2 x D
 Chip removal (like picture)
 Form C straight flutes
 material: HSSG medium to 900 N/mm² 27,1 HRC

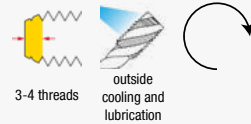

BSF

	D1	D2	L1	L2	□		No.	€	No.	€
BSF 3/16 x 32	4,76	6,0	50	14	4,9	3,90	220101001	6,75	220301001	9,83
BSF 1/4 x 26	6,35	6,0	50	18	4,9	5,30	220101002	6,75	220301002	9,83
BSF 5/16 x 22	7,94	6,0	56	22	4,9	6,80	220101003	7,58	220301003	10,99
BSF 3/8 x 20*	9,53	7,0	63	22	5,5	8,30	220101004	8,43	220301004	12,16
BSF 7/16 x 18	11,11	8,0	63	22	6,2	9,70	220101005	10,62	220301005	15,44
BSF 1/2 x 16	12,70	9,0	75	24	7,0	11,10	220101006	12,81	220301006	18,71
BSF 9/16 x 16	14,29	11,0	80	28	9,0	12,70	220101007	16,86	220301007	24,56
BSF 5/8 x 14	15,88	12,0	80	28	9,0	14,00	220101008	18,87	220301008	27,60
BSF 3/4 x 12	19,05	14,0	95	32	11,0	16,80	220101009	25,28	220301009	36,95
BSF 7/8 x 11	22,23	18,0	100	36	14,5	19,70	220101010	33,71	220301010	49,12
BSF 1" x 10	25,40	18,0	110	40	14,5	22,70	220101011	38,76	220301011	56,61

* BSF 3/8 = Fisher thread

Round Dies for general use

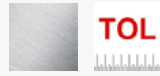

material: HSS 2A

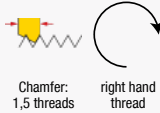
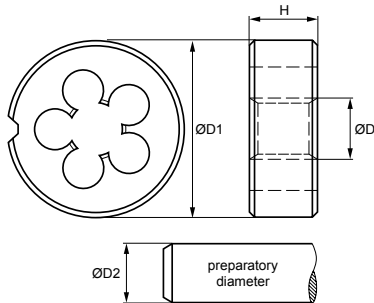
 Chamfer: 1,5 threads
right hand thread

Hexagon Die Nuts for general use

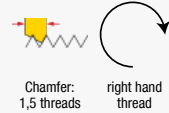
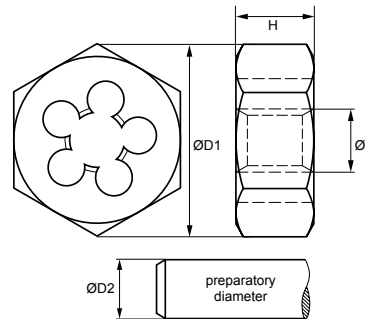

material: HSS medium

 Chamfer: 1,5 threads
right hand thread

BSF

	D	D1	H	D2	No.	€
BSF 3/16 x 32	4,76	20	7	4,67	221401001	12,27
BSF 1/4 x 26	6,35	20	7	6,25	221401002	12,27
BSF 5/16 x 22	7,94	25	9	7,83	221401003	14,03
BSF 3/8 x 20	9,53	30	11	9,41	221401004	15,55
BSF 7/16 x 18	11,11	30	11	10,99	221401005	18,01
BSF 1/2 x 16	12,70	38	10	12,57	221401006	23,15
BSF 9/16 x 16	14,29	38	10	14,12	221401007	25,73
BSF 5/8 x 14	15,88	45	14	15,73	221401008	35,08
BSF 3/4 x 12	19,05	45	14	18,89	221401009	35,08
BSF 7/8 x 11	22,23	55	22	22,11	221401010	47,95
BSF 1" x 10	25,40	55	22	25,28	221401011	47,95

BSF

	D	D1	H	D2	No.	€
BSF 3/16 x 32	4,76	19	7	4,67	221501001	17,20
BSF 1/4 x 26	6,35	19	7	6,25	221501002	17,20
BSF 5/16 x 22	7,94	22	9	7,83	221501003	19,07
BSF 3/8 x 20	9,53	27	11	9,41	221501004	23,38
BSF 7/16 x 18	11,11	27	11	10,99	221501005	23,38
BSF 1/2 x 16	12,70	36	10	12,57	221501006	36,84
BSF 9/16 x 16	14,29	36	10	14,12	221501007	36,84
BSF 5/8 x 14	15,88	41	14	15,73	221501008	56,49
BSF 3/4 x 12	19,05	41	14	18,89	221501009	56,49
BSF 7/8 x 11	22,23	50	16	22,11	221501010	66,66
BSF 1" x 10	25,40	50	16	25,28	221501011	66,66

TR

Trapezoidal thread / DIN 103

Efficient internal thread cutting.

The short structural type makes that tap usable by hand. The Short-Machine-Tap is also usable by machine.

A Hand-Tap-Set includes 3 taps:

- Taper Tap
- Intermediate Tap
- Finish Tap

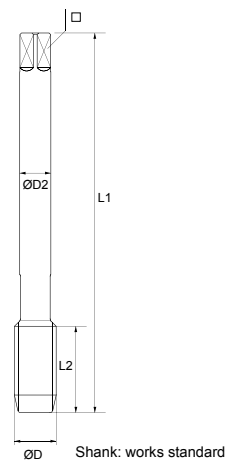

Hand Tap Sets for general use

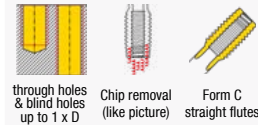

through holes & blind holes up to 1 x D
 Chip removal (like picture)
 Form C straight flutes

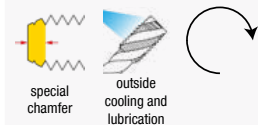

Hand Tap Sets for general use

Left Hand

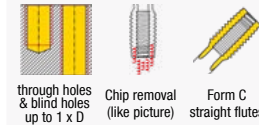

through holes & blind holes up to 1 x D
 Chip removal (like picture)
 Form C straight flutes

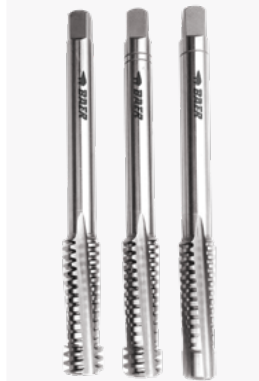
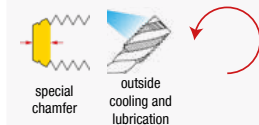

TR

	D2	L1	L2	□		No.	€	No.	€
TR 9 x 1,5	7,0	100,0	22	5,5	7,60	230301001	*	230302001	*
TR 10 x 1,5	7,0	100,0	22	5,5	8,60	230301002	458,55	230302002	715,46
TR 10 x 2	7,0	90,0	34	5,5	8,20	230301003	371,51	230302003	786,89
TR 10 x 3	7,0	100,0	40	5,5	7,60	230301004	371,51	230302004	786,89
TR 11 x 2	8,0	100,0	22	6,2	9,20	230301005	580,66	230302005	905,56
TR 12 x 2	9,0	110,0	25	7,0	10,20	230301006	504,28	230302006	786,89
TR 12 x 3	8,0	110,0	40	6,2	9,25	230301007	387,26	230302007	786,89
TR 14 x 2	11,0	110,0	26	9,0	12,20	230301008	685,50	230302008	1.039,21
TR 14 x 3	10,0	130,0	45	8,0	11,25	230301009	491,15	230302009	944,74
TR 14 x 4	10,0	130,0	55	8,0	10,70	230301010	503,75	230302010	944,74
TR 16 x 2	12,0	110,0	27	9,0	14,20	230301011	685,50	230302011	1.039,21
TR 16 x 4	11,0	140,0	55	9,0	12,25	230301012	503,75	230302012	944,74
TR 18 x 2	14,0	125,0	27	11,0	16,20	230301013	967,77	230302013	1.509,27
TR 18 x 4	12,0	150,0	55	9,0	14,25	230301014	702,10	230302014	1.397,51
TR 20 x 2	16,0	140,0	27	12,0	18,20	230301015	1.036,91	230302015	1.615,26
TR 20 x 4	14,0	160,0	55	11,0	16,25	230301016	739,88	230302016	1.495,44
TR 22 x 3	18,0	160,0	34	14,5	19,25	230301017	1.307,65	230302017	2.040,39
TR 22 x 5	16,0	175,0	65	12,0	17,30	230301018	938,23	230302018	1.889,46
TR 24 x 3	18,0	160,0	36	14,5	21,25	230301019	1.451,67	230302019	2.252,38
TR 24 x 5	18,0	190,0	65	14,5	19,30	230301020	1.026,39	230302020	2.085,32
TR 26 x 3	20,0	160,0	36	16,0	23,25	230301021	1.601,44	230302021	2.487,41
TR 26 x 5	20,0	210,0	70	16,0	21,30	230301022	1.139,73	230302022	2.273,11
TR 28 x 3	22,0	180,0	40	18,0	25,25	230301023	1.745,45	230302023	2.717,83
TR 28 x 5	22,0	220,0	70	18,0	23,30	230301024	1.240,48	230302024	2.518,52
TR 30 x 3	22,0	180,0	40	18,0	27,25	230301025	1.902,02	230302025	2.968,99
TR 30 x 6	22,0	240,0	80	18,0	24,30	230301026	1.322,34	230302026	2.675,20
TR 32 x 6	25,0	255,0	80	20,0	26,30	230301027	1.611,99	230302027	3.093,43

* on request

TR

Trapezoidal thread / DIN 103

Machine Nut Tap with long shank for cutting Nuts.

For all through holes up to a max. thread depth of 1,0 x diameter.

Please note that this tap can only take cutting forces up to 1,0 times diameter.

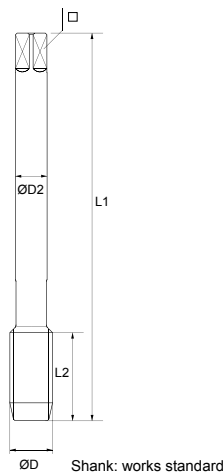

Machine Nut Taps for general use

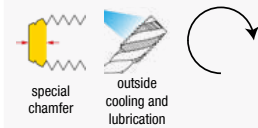
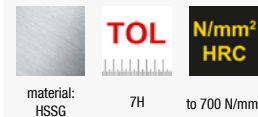
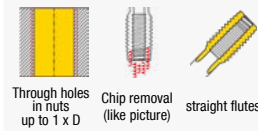

Machine Nut Taps for general use

Left Hand

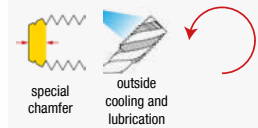
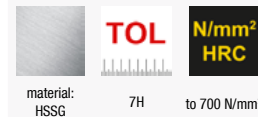
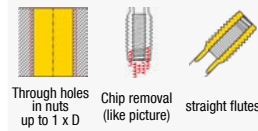

TR	D2	L1	L2	□		No.	€	No.	€
TR 8 x 1,5	6,0	90,0	55	4,9	6,70				
TR 9 x 2	7,0	110,0	63	5,5	7,20				
TR 10 x 2	7,0	110,0	63	5,5	8,20	230901001	261,95	230902001	367,74
TR 10 x 3	7,0	125,0	75	5,5	7,60	230901002	261,95	230902002	367,74
TR 12 x 2	9,0	135,0	75	7,0	10,20				
TR 12 x 3	8,0	165,0	111	6,2	9,25	230901003	226,69	230902003	317,36
TR 14 x 2	10,0	150	90	8,0	12,20				
TR 14 x 3	10,0	140	85	8,0	11,25	230901004	241,80	230902004	340,03
TR 14 x 4	10,0	170	112	8,0	10,70	230901005	241,80	230902005	340,03
TR 16 x 2	12,0	160	90	9,0	14,20				
TR 16 x 4	11,0	180	116	9,0	12,25	230901006	264,47	230902006	367,74
TR 18 x 2	14,0	175	90	11,0	16,20				
TR 18 x 4	12,0	190	120	9,0	14,25	230901007	270,76	230902007	367,74
TR 20 x 2	16,0	185	105	12,0	18,20				
TR 20 x 4	14,0	200	124	11,0	16,25	230901008	280,84	230902008	394,18
TR 22 x 3	16,0	220	125	12,0	19,25				
TR 22 x 4	16,0	210	130	12,0	18,25	230901009	365,22		
TR 22 x 5	16,0	235	155	12,0	17,30	230901010	365,22	230902009	510,04
TR 24 x 3	18,0	220	130	14,5	21,25				
TR 24 x 5	18,0	245	160	14,5	19,30	230901011	418,11	230902010	585,61
TR 26 x 3	20,0	235	130	16,0	23,25				
TR 26 x 5	20,0	255	165	16,0	21,30	230901012	440,78	230902011	612,05
TR 28 x 3	22,0	245	140	18,0	25,25				
TR 28 x 5	22,0	265	170	18,0	23,30	230901013	491,15	230902012	681,32
TR 30 x 3	22,0	250	140	18,0	27,25				
TR 30 x 6	22,0	290	185	18,0	24,30	230901014	573,01	230902013	799,70
TR 32 x 6	25,0	300	191	20,0	26,30	230901015	705,25	230902014	969,71
TR 36 x 6	28,0	310	200	22,0	30,50	230901016	717,84	230902015	994,90

TR

Trapezoidal thread / DIN 103

Machine Nut Tap with long shank for cutting Nuts.

For all through holes up to a max. thread depth of 1,5 x diameter.

Please note that this tap can only take cutting forces up to 1,5 times diameter.

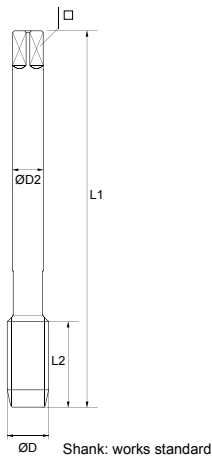

Machine Nut Taps for stainless steels

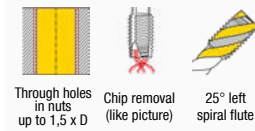

Through holes in nuts up to 1,5 x D
 Chip removal (like picture)
 25° left spiral flute
TOL
 material: HSSE-nitrated
 7H to 900 N/mm² 27,1 HRC

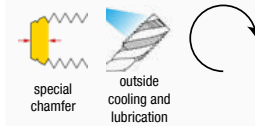

Machine Nut Taps for stainless steels

Left Hand

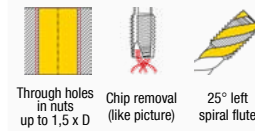

Through holes in nuts up to 1,5 x D
 Chip removal (like picture)
 25° left spiral flute
TOL
 material: HSSE-nitrated
 7H to 900 N/mm² 27,1 HRC

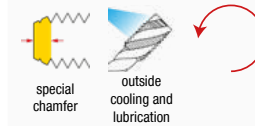

TR	D2	L1	L2	□		No.	€	No.	€
TR 8 x 1,5	6,0	90,0	55	4,9	6,70	230905001	*	230905001L	*
TR 9 x 2	7,0	110,0	63	5,5	7,20	230905002	*	230905002L	*
TR 10 x 2	7,0	110,0	63	5,5	8,20	230905003	*	230905003L	*
TR 10 x 3	7,0	125,0	75	5,5	7,60	230905004	*	230905004L	*
TR 12 x 2	9,0	135,0	75	7,0	10,20	230905005	*	230905005L	*
TR 12 x 3	8,0	165,0	111	6,2	9,25	230905006	*	230905006L	*
TR 14 x 2	10,0	150,0	90	8,0	12,20	230905007	*	230905007L	*
TR 14 x 3	10,0	140,0	85	8,0	11,25	230905008	*	230905008L	*
TR 14 x 4	10,0	170,0	112	8,0	10,70	230905009	*	230905009L	*
TR 16 x 2	12,0	160,0	90	9,0	14,20	230905010	*	230905010L	*
TR 16 x 4	11,0	180,0	116	9,0	12,25	230905011	*	230905011L	*
TR 18 x 2	14,0	175,0	90	11,0	16,20	230905012	*	230905012L	*
TR 18 x 4	12,0	190,0	120	9,0	14,25	230905013	*	230905013L	*
TR 20 x 2	16,0	185,0	105	12,0	18,20	230905014	*	230905014L	*
TR 20 x 4	14,0	200,0	124	11,0	16,25	230905015	*	230905015L	*
TR 22 x 3	16,0	220,0	125	12,0	19,25	230905016	*	230905016L	*
TR 22 x 4	16,0	210,0	130	12,0	18,25	230905017	*	230905017L	*
TR 22 x 5	16,0	235,0	155	12,0	17,30	230905018	*	230905018L	*
TR 24 x 3	18,0	220,0	130	14,5	21,25	230905019	*	230905019L	*
TR 24 x 5	18,0	245,0	160	14,5	19,30	230905020	*	230905020L	*
TR 26 x 3	20,0	235,0	130	16,0	23,25	230905021	*	230905021L	*
TR 26 x 5	20,0	255,0	165	16,0	21,30	230905022	*	230905022L	*
TR 28 x 3	22,0	245,0	140	18,0	25,25	230905023	*	230905023L	*
TR 28 x 5	22,0	265,0	170	18,0	23,30	230905024	*	230905024L	*
TR 30 x 3	22,0	250,0	140	18,0	27,25	230905025	*	230905025L	*
TR 30 x 6	22,0	290,0	185	18,0	24,30	230905026	*	230905026L	*
TR 32 x 6	25,0	300,0	191	20,0	26,30	230905027	*	230905027L	*

* on request

Round Dies for general use

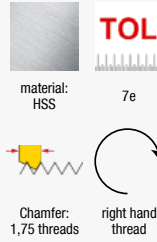

Round Dies for general use Left Hand

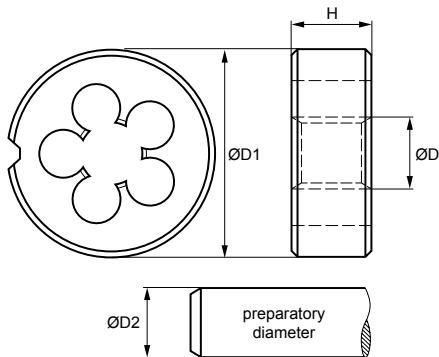
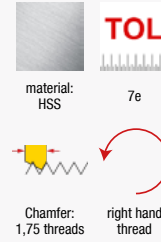

TR	D1	H	D2	No.	€	No.	€
TR 10 x 2	38,0	14	9,91	231401001	116,39	231402001	265,70
TR 10 x 3	38,0	14	9,88	231401002	165,95	231402002	*
TR 12 x 2	38,0	14	11,91	231401003	165,95	231402003	*
TR 12 x 3	38,0	14	11,88	231401004	126,21	231402004	369,89
TR 14 x 2	38,0	14	13,91	231401005	165,95	231402005	*
TR 14 x 3	45,0	18	13,88	231401006	177,64	231402006	418,95
TR 14 x 4	45,0	18	13,85	231401007	196,63	231402007	335,16
TR 16 x 2	45,0	18	15,91	231401008	231,39	231402008	*
TR 16 x 4	45,0	18	15,85	231401009	161,86	231402009	379,82
TR 18 x 2	45,0	18	17,91	231401010	259,44	231402010	*
TR 18 x 4	45,0	18	17,85	231401011	163,61	231402011	379,82
TR 20 x 2	45,0	18	19,91	231401012	264,12	231402012	*
TR 20 x 4	55,0	22	19,85	231401013	212,70	231402013	419,51
TR 22 x 5	55,0	22	21,84	231401014	281,64	231402014	863,26
TR 24 x 5	65,0	25	23,84	231401015	281,64	231402015	601,97
TR 26 x 5	65,0	25	25,84	231401016	281,64	231402016	863,26
TR 28 x 5	65,0	25	27,84	231401017	301,51	231402017	986,74
TR 30 x 6	65,0	25	29,82	231401018	340,07	231402018	976,82

NPT

National standard taper 1:16 pipe thread ANSI B 1.20.1

NPTF

National standard taper 1:16 pipe thread ANSI B 1.20.3

Efficient internal thread cutting.

The short structural type makes that tap usable by machine and hand.

Application:

- non abrasive material up to 900 N/mm²
- unalloyed and low alloyed steel

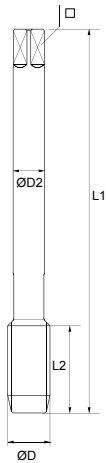

Short Machine Taps Form D for through holes and blind holes

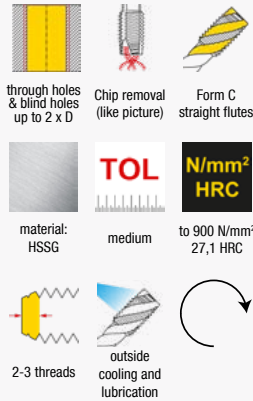

NPT

	D1	D2	L1	L2	□		No.	€
NPT 1/16 x 27	7,90	19,0	65	19	5,5	6,00	240101001	18,04
NPT 1/8 x 27	10,24	19,0	65	19	5,5	8,25	240101002	15,13
NPT 1/4 x 18	13,62	25,0	70	25	9,0	10,70	240101003	16,87
NPT 3/8 x 18	17,06	26,0	75	26	9,0	14,10	240101004	23,27
NPT 1/2 x 14	21,22	31,0	80	31	12,0	17,40	240101005	29,10
NPT 3/4 x 14	26,57	33,0	100	33	16,0	22,60	240101006	38,99
NPT 1" x 11,5	33,23	38,0	110	38	20,0	28,50	240101007	61,08
NPT 1.1/4 x 11,5	41,99	41,0	125	41	24,0	37,00	240101008	93,54
NPT 1.1/2 x 11,5	48,05	42,0	140	42	29,0	43,50	240101009	175,42
NPT 2" x 11,5	60,09	44,0	160	44	29,0	55,00	240101010	216,34

NPTF

	D1	D2	L1	L2	□		No.	€
NPTF 1/16 x 27	7,87	19,0	65	19	5,5	6,00	250101001	23,93
NPTF 1/8 x 27	10,22	19,0	65	19	5,5	8,25	250101002	19,31
NPTF 1/4 x 18	13,58	25,0	70	25	9,0	10,70	250101003	22,67
NPTF 3/8 x 18	17,02	26,0	75	26	9,0	14,10	250101004	28,97
NPTF 1/2 x 14	21,21	31,0	80	31	12,0	17,40	250101005	36,42
NPTF 3/4 x 14	26,57	33,0	100	33	16,0	22,60	250101006	48,49
NPTF 1" x 11,5	33,20	38,0	110	38	20,0	28,50	250101007	78,08
NPTF 1.1/4 x 11,5	41,95	41,0	125	41	24,0	37,00	250101008	116,39
NPTF 1.1/2 x 11,5	48,02	42,0	140	42	29,0	43,50	250101009	193,94
NPTF 2" x 11,5	60,06	44,0	160	44	29,0	55,00	250101010	258,17

Round Dies for general use

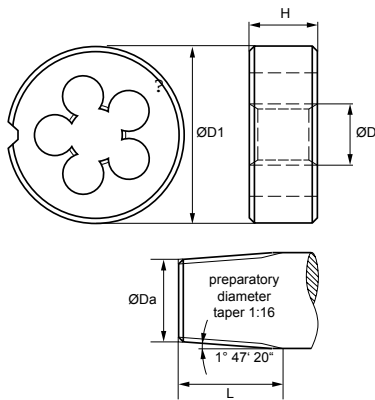
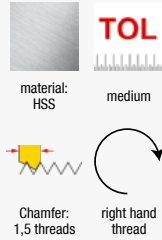

Hexagon Die Nuts for general use

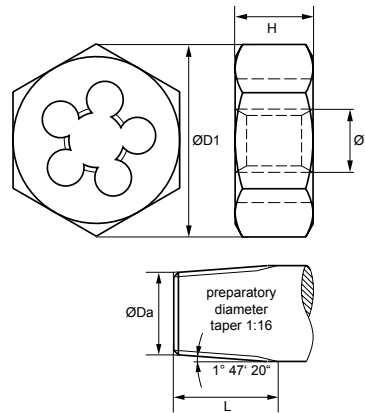
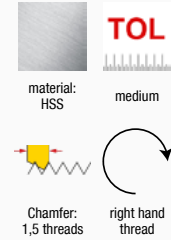

NPT	D	D1	H	Da x L	No.	€
NPT 1/16 x 27	7,90	25	9	7,58 x 8,4	241401001	39,67
NPT 1/8 x 27	10,24	30	11	9,93 x 8,5	241401002	42,19
NPT 1/4 x 18	13,62	38	14	13,18 x 12,7	241401003	51,63
NPT 3/8 x 18	17,06	45	14	16,60 x 12,9	241401004	65,49
NPT 1/2 x 14	21,22	45	18	20,63 x 16,8	241401005	65,49
NPT 5/8 x 14	23,90	55	22		241401006	104,53
NPT 3/4 x 14	26,57	55	22	25,95 x 17,1	241401007	104,53
NPT 7/8 x 14	29,90	65	25		241401008	154,90
NPT 1" x 11,5	33,23	65	25	32,51 x 21,3	241401009	154,90
NPT 1.1/4 x 11,5	41,99	75	26	41,23 x 21,9	241401010	182,61
NPT 1.1/2 x 11,5	48,05	90	27	47,30 x 22,3	241401011	298,47
NPT 2" x 11,5	60,09	105	28	59,31 x 23,1	241401012	394,18

NPT	D	D1	H	Da x L	No.	€
NPT 1/16 x 27	7,90	22	9	7,58 x 8,4	241501001	49,25
NPT 1/8 x 27	10,24	27	11	9,93 x 8,5	241501002	53,34
NPT 1/4 x 18	13,62	36	14	13,18 x 12,7	241501003	65,65
NPT 3/8 x 18	17,06	41	14	16,60 x 12,9	241501004	82,06
NPT 1/2 x 14	21,22	41	14	20,63 x 16,8	241501005	82,06
NPT 3/4 x 14	26,57	50	22	25,95 x 17,1	241501006	129,95
NPT 1" x 11,5	33,23	60	25	32,51 x 21,3	241501007	191,49
NPT 1.1/4 x 11,5	41,99	70	25	41,23 x 21,9	241501008	228,42
NPT 1.1/2 x 11,5	48,05	85	28	47,30 x 22,3	241501009	369,29
NPT 2" x 11,5	60,09	100	28	59,31 x 23,1	241501010	499,22

NPS

National standard straight pipe thread

Efficient internal thread cutting.

The short structural type makes that tap usable by machine and hand.

Application:

- ⚙ non abrasive material up to 900 N/mm²
- ⚙ unalloyed and low alloyed steel

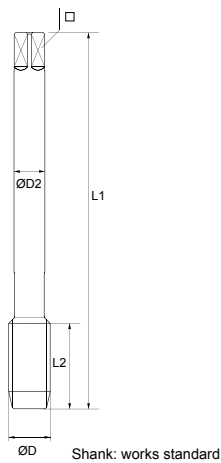

Short Machine Taps

Form C for through holes and blind holes

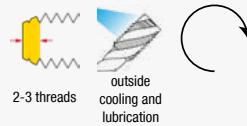
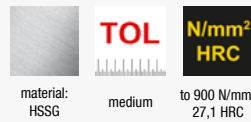
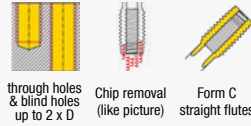

Round Dies

for general use

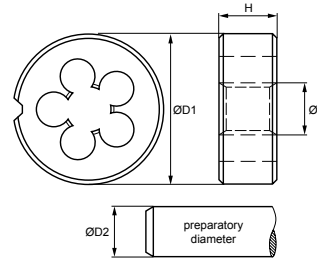
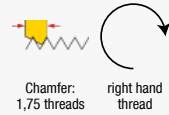
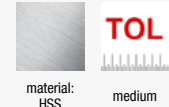

NPS

	D1	D2	L1	L2	□	⚙	No.	€
NPS 1/16 x 27	7,90	8,0	54	18	6,0	6,40	260101001	20,16
NPS 1/8 x 27	10,24	8,0	55	19	6,0	8,90	260101002	17,39
NPS 1/4 x 18	13,62	11,0	62	28	9,0	11,50	260101003	20,41
NPS 3/8 x 18	17,06	14,0	65	28	11,0	15,00	260101004	24,70
NPS 1/2 x 14	21,22	18,0	80	35	14,0	18,50	260101005	30,62
NPS 3/4 x 14	26,57	23,0	85	35	17,0	23,80	260101006	40,32
NPS 1" x 11,5	33,23	26,0	95	45	21,0	29,90	260101007	64,26
NPS 1,1/4 x 11,5	41,99	32,0	105	45	26,0	38,60	260101008	97,02
NPS 1,1/2 x 11,5	48,05	38,0	110	45	29,0	44,70	260101009	216,72
NPS 2" x 11,5	60,09	46,0	120	50	35,0	56,70	260101010	347,76

NPSM

	D	D1	H	D2	No.	€
NPSM 1/8 x 27	10,24	30	11	9,99	261401001	185,66
NPSM 1/4 x 18	13,62	38	10	13,25	261401002	194,04
NPSM 3/8 x 18	17,06	45	14	16,70	261401003	219,29
NPSM 1/2 x 14	21,22	45	14	20,78	261401004	209,48
NPSM 3/4 x 14	26,57	55	16	26,14	261401005	316,42
NPSM 1" x 11,5	33,23	65	18	32,69	261401006	1.035,30
NPSM 1.1/4 x 11,5	41,99	75	20	41,45	261401007	1.516,20

RC (BSPT)

Whitworth tapered pipe thread / DIN 2999

RP (BSPP)

British standard whitworth pipe thread / ISO 7-1

Efficient internal thread cutting.

The short structural type makes that tap usable by machine and hand.

Application:

- ⚙ non abrasive material up to 900 N/mm²
- ⚙ unalloyed and low alloyed steel

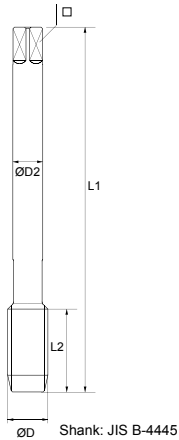

Short Machine Taps

Form C for through holes and blind holes

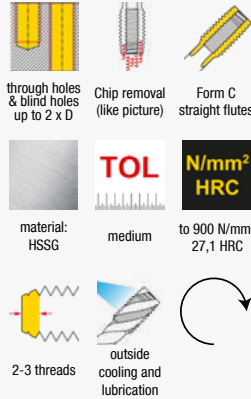

Hexagon Die Nuts

for general use

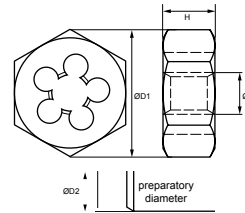
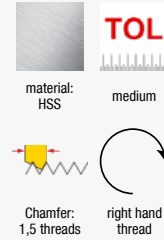

RC (BSPT)	D1	D2	L1	L2	□	⚙	No.	€
RC 1/16 x 28	7,72	8,0	55	17,5	6,0	6,30		*
RC 1/8 x 28	9,73	8,0	55	19	6,0	8,30	270101001	9,24
RC 1/4 x 19	13,16	11,0	62	28	9,0	11,10	270101002	10,75
RC 3/8 x 19	16,66	14,0	65	28	11,0	14,50	270101003	16,96
RC 1/2 x 14	20,95	18,0	80	35	14,0	18,10	270101004	21,28
RC 3/4 x 14	26,44	23,0	85	35	17,0	23,50	270101005	31,22
RC 1" x 11	33,25	26,0	95	45	21,0	29,50	270101006	47,12
RC 1.1/4 x 11	41,91	32,0	105	45	26,0	38,25		*
RC 1.1/2 x 11	47,80	38,0	110	45	29,0	44,25		*
RC 2" x 11	59,61	46,0	120	50	35,0	56,00		*

R (BSPT)	D	D1	H	No.	€
R 1/8 x 28	9,73	27	11	271501001	49,12
R 1/4 x 19	13,16	36	14	271501002	60,45
R 3/8 x 19	16,66	41	15	271501003	75,56
R 1/2 x 14	20,95	50	19	271501004	75,56
R 3/4 x 14	26,44	60	20	271501005	119,64
R 1" x 11	33,25	60	25	271501006	176,31
R 1.1/4 x 11	41,91	85	26	271501007	210,31
R 1.1/2 x 11	47,80	85	26	271501008	340,03
R 2" x 11	59,61	100	31	271501009	459,67

RP (BSPP)	D1	D2	L1	L2	□	⚙	No.	€
RP 1/16 x 28	7,72	8,0	55	18	6,0	6,55	280101001	8,66
RP 1/8 x 28	9,73	8,0	55	19	6,0	8,60	280101002	8,66
RP 1/4 x 19	13,16	11,0	62	28	9,0	11,50	280101003	10,64
RP 3/8 x 19	16,66	14,0	65	28	11,0	15,00	280101004	17,07
RP 1/2 x 14	20,95	18,0	80	35	14,0	18,50	280101005	26,25
RP 3/4 x 14	26,44	23,0	85	35	17,0	24,00	280101006	45,29
RP 1" x 11	33,25	26,0	95	45	21,0	30,25	280101007	59,06
RP 1.1/4 x 11	41,91	32,0	105	45	26,0	38,75	280101008	89,26
RP 1.1/2 x 11	47,80	38,0	110	45	29,0	44,75	280101009	123,36
RP 2" x 11	59,61	46,0	120	50	35,0	56,50	280101010	187,70

* on request

BA

British Association thread / BS 93

Efficient internal thread cutting.

The short structural type makes that tap usable by hand. The Short-Machine-Tap is also usable by machine.

A Hand-Tap-Set includes 3 taps:

- Taper Tap
- Intermediate Tap
- Finish Tap

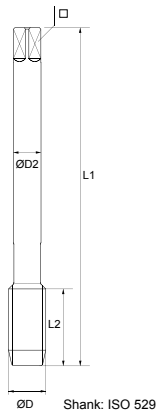

Hand Tap Sets for general use



Round Dies for general use

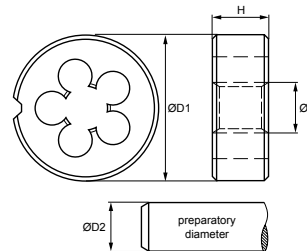

BA	D1	D2	L1	L2	□		No.	€
BA 0	6,00	6,3	66	19,0	5,0	5,10	290313001	20,35
BA 1	5,30	5,6	62	17,0	4,5	4,50	290313002	20,35
BA 2	4,70	5,0	58	16,0	4,0	4,00	290313003	20,35
BA 3	4,10	4,5	53	13,0	3,6	3,40	290313004	20,35
BA 4	3,60	3,6	50	13,0	2,8	3,00	290313005	20,35
BA 5	3,20	3,2	48	11,0	2,5	2,65	290313006	20,35
BA 6	2,80	2,8	45	9,5	2,2	2,30	290313007	20,35

BA	D	D1	H	D2	No.	€
BA 0	6,00	20,6	6,35	5,90	291401001	13,97
BA 1	5,30	20,6	6,35	5,21	291401002	13,97
BA 2	4,70	20,6	6,35	4,61	291401003	13,97
BA 3	4,10	20,6	6,35	4,02	291401004	13,97
BA 4	3,60	20,6	6,35	3,52	291401005	13,97
BA 5	3,20	20,6	6,35	3,14	291401006	13,97
BA 6	2,80	20,6	6,35	2,74	291401007	13,97
BA 7	2,50	20,6	6,35	2,44	291401008	*
BA 8	2,20	20,6	6,35	2,15	291401009	*
BA 10	1,70	20,6	6,35	1,66	291401010	*

* on request

W

Tapered whitworth DIN 477 for screw sockets taper 3:25

Efficient internal thread cutting.

The short structural type makes that tap usable by hand. The Short-Machine-Tap is also usable by machine.

A Hand-Tap-Set includes 3 taps:

- Taper Tap
- Intermediate Tap
- Finish Tap

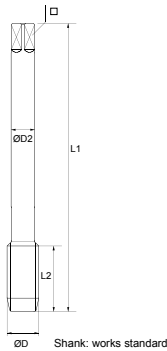

Short Machine Taps

Form C for through holes and blind holes

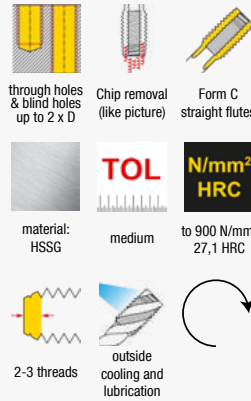

Round Dies

for general use

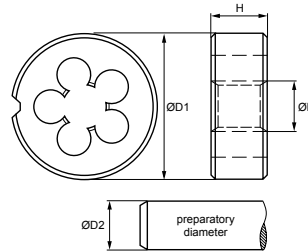
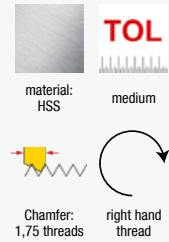

W	D1	D2	L1	L2			No.	€
W 19,8 x 14 conical	19,80	16,0	90	32	12,0	14,70	300101001	178,83
W 28,8 x 14 conical	28,80	22,0	100	40	18,0	22,70	300101002	201,50
W 31,3 x 14 conical	31,30	22,0	110	40	18,0	25,20	300101003	231,72
W 21,8 x 14 cyl. - right	21,80	18,0	80	22	14,5	19,75	310101004	*
W 21,8 x 14 cyl. - left	21,80	18,0	80	22	14,5	19,75	310101005	*
W 24,32 x 14 cylindrical	24,32	18,0	90	22	14,5	22,25	310101006	*

W	D	D1	H	D2	No.	€
W 19,8 x 14 conical	19,80	45	25	17,34	301401001	426,12
W 28,8 x 14 conical	28,80	65	30	25,74	301401002	609,68
W 21,8 x 14 cyl. - right	21,80	55	16	21,58	311401003	288,31
W 21,8 x 14 cyl. - left	21,80	55	16	21,58	311401004	317,52
W 24,32 x 14 cylindrical	24,32	55	16	24,10	311401005	388,08

PG

Steel Conduit Thread / DIN 40430

Efficient internal thread cutting.

The short structural type makes that tap usable by hand. The Short-Machine-Tap is also usable by machine.

Application:

- non abrasive material up to 900 N/mm²
- unalloyed and low alloyed steel

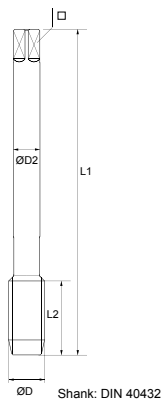

Short Machine Taps

Form D for through holes and blind holes



Round Dies
for general use

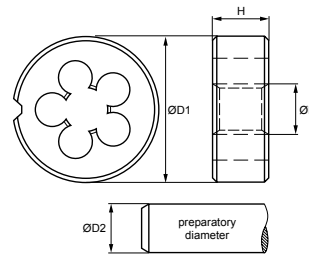

PG	D1	D2	L1	L2	□		No.	€
PG 7 x 20	12,50	9,0	70	22	7,0	11,35	320101001	12,27
PG 9 x 18	15,20	12,0	70	22	9,0	13,95	320101002	16,38
PG 11 x 18	18,60	14,0	80	22	11,0	17,35	320101003	27,02
PG 13,5 x 18	20,40	16,0	80	22	12,0	19,15	320101004	31,92
PG 16 x 18	22,50	18,0	80	22	14,5	21,25	320101005	38,70
PG 21 x 16	28,30	22,0	90	22	18,0	26,90	320101006	56,88
PG 29 x 16	37,00	28,0	100	25	22,0	35,60	320101007	94,45
PG 36 x 16	47,00	36,0	140	40	29,0	45,60	320101008	151,12
PG 42 x 16	54,00	40,0	140	40	32,0	52,60	320101009	239,28
PG 48 x 16	59,30	45,0	160	40	35,0	57,90	320101010	283,36

PG	D	D1	H	D2	No.	€
PG 7 x 20	12,50	38	10	12,50	321401001	49,12
PG 9 x 18	15,20	45	14	15,20	321401002	59,82
PG 11 x 18	18,60	45	14	18,60	321401003	59,82
PG 13,5 x 18	20,40	45	14	20,40	321401004	59,82
PG 16 x 18	22,50	55	16	22,50	321401005	70,52
PG 21 x 16	28,30	65	18	28,30	321401006	108,31
PG 29 x 16	37,00	65	18	37,00	321401007	108,31
PG 36 x 16	47,00	90	22	47,00	321401008	214,09
PG 42 x 16	54,00	105	22	54,00	321401009	272,86
PG 48 x 16	59,30	105	22	59,30	321401010	272,86

FG Bicycle thread / DIN 79012

Tap for machine use in through hole and blind hole.

The short lead-in chamfer makes that tap universal in application. The flutes can hold the most part of the chips.

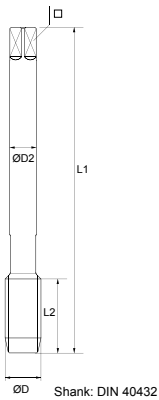

FG	D1	D2	L1	L2	□	□	No.	€
FG 6,35 x 26	6,35	7,0	80	14	5,5	5,50	330501001	88,16
FG 7,9 x 26	7,90	8,0	90	16	6,2	7,00	330501002	94,45
FG 9,5 x 26	9,50	7,0	90	16	5,5	8,60	330501003	94,45
FG 14,3 x 20 right	14,30	11,0	100	22	9,0	13,10	330501004	100,75
FG 14,3 x 20 left	14,30	11,0	100	22	9,0	13,10	330501005	113,34
FG 25,4 x 24	25,40	14,0	110	22	11,0	24,50	330501006	163,72

BSC

BSC 1/4 x 26	6,35	6,0	56	14	4,9	5,55	340101001	88,16
BSC 5/16 x 26	7,94	6,0	63	16	4,9	7,10	340101002	94,45
BSC 3/8 x 26	9,53	7,0	63	16	5,5	8,65	340101003	100,75
BSC 9/16 x 20 right	14,29	11,0	70	22	9,0	13,15	340101004	100,75
BSC 9/16 x 20 left	14,29	11,0	70	22	9,0	13,15	340101005	113,34
BSC 1" x 24	25,40	14,0	70	22	11,0	24,50	340101006	163,72

BSC British bicycle thread / RS 811

Short Machine Taps Form C for through holes and blind holes



through holes & blind holes up to 1,5 x D
Chip removal (like picture)
Form C straight flutes



material: HSSE medium to 900 N/mm² 27,1 HRC



2-3 threads outside cooling and lubrication



Round Dies for general use



material: HSS medium



Chamfer: 1,75 threads right hand thread

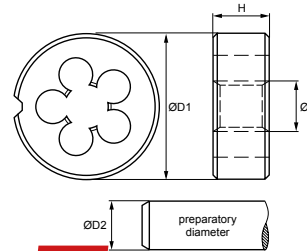

FG	D	D1	H	D2	No.	€
FG 6,35 x 26	6,35	20	7	6,24	331401001	45,34
FG 7,9 x 26	7,90	25	9	7,82	331401002	64,23
FG 9,5 x 26	9,50	30	11	9,40	331401003	89,42
FG 14,3 x 20 right	14,30	38	10	14,40	331401004	137,27
FG 14,3 x 20 left	14,30	38	10	14,40	331401005	164,98
FG 25,4 x 24	25,40	55	16	25,25	331401006	374,03

BSC

BSC 1/4 x 26	6,35	20,6	6,35	6,24	341401001	45,34
BSC 5/16 x 26	7,94	25,4	9,5	7,82	341401002	64,23
BSC 3/8 x 26	9,53	25,4	9,5	9,40	341401003	89,42
BSC 7/16 x 26	11,11	25,4	9,5	10,98	341401004	*
BSC 9/16 x 20 right	14,29	38,1	12,7	14,14	341401005	137,27
BSC 9/16 x 20 left	14,29	38,1	12,7	14,14	341401006	164,98
BSC 1" x 24	25,40	55	16	25,25	341401007	374,03

RD knuckle thread / DIN 405

Tap for machine use in through hole and blind hole.

The short lead-in chamfer makes that tap universal in application. The flutes can hold the most part of the chips.

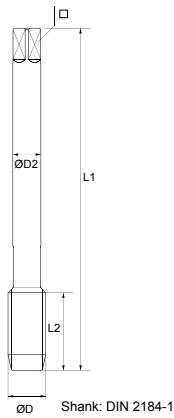

Shank: DIN 2184-1

RMS Royal Microscopical Society / DIN 58888

Short Machine Taps Form C for through holes and blind holes



through holes & blind holes up to 1,5 x D
Chip removal (like picture)
Form C straight flutes



material: HSSE medium to 800 N/mm²



2-3 threads
outside cooling and lubrication



Round Dies for general use



material: HSS medium



Chamfer: 1,75 threads
right hand thread

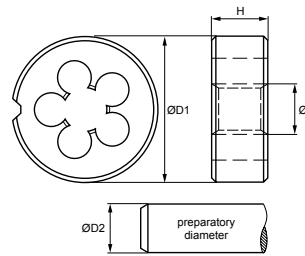

RD	D1	D2	L1	L2	□	✎	No.	€
Rd 8 x 1/10	8,25	6,0	90	26	4,9	5,71	350501001	92,56
Rd 9 x 1/10	9,25	7,0	90	26	5,5	6,71	350501002	92,56
Rd 10 x 1/10	10,25	7,0	100	28	5,5	7,71	350501003	92,56
Rd 11 x 1/10	11,25	8,0	100	28	6,2	8,71	350501004	113,34
Rd 12 x 1/10	12,25	9,0	110	28	7,0	9,71	350501005	125,94
Rd 14 x 1/8	14,32	11,0	110	32	9,0	11,14	350501006	158,68
Rd 16 x 1/8	16,32	12,0	110	32	9,0	13,14	350501007	166,24
Rd 18 x 1/8	18,32	14,0	125	32	11,0	15,14	350501008	198,98
Rd 20 x 1/8	20,32	16,0	140	32	12,0	17,14	350501009	198,98
Rd 22 x 1/8	22,32	18,0	140	32	14,5	19,14	350501010	258,17
Rd 24 x 1/8	24,32	18,0	160	34	14,5	21,14	350501011	311,06
Rd 26 x 1/8	26,32	20,0	160	36	16,0	23,14	350501012	363,96
Rd 28 x 1/8	28,32	20,0	160	36	16,0	25,14	350501013	390,40
Rd 30 x 1/8	30,32	22,0	180	36	18,0	27,14	350501014	410,55
Rd 32 x 1/8	32,82	25,0	180	36	20,0	29,14	350501015	549,08
Rd 34 x 1/8	34,32	28,0	200	36	22,0	31,14	350501016	623,39
Rd 36 x 1/8	36,32	28,0	200	36	22,0	33,14	350501017	628,42
Rd 38 x 1/8	38,32	28,0	200	38	22,0	35,14	350501018	727,91
Rd 40 x 1/6	40,42	32,0	200	50	24,0	36,19	350501019	860,15

RD	D	D1	H	D2	No.	€
Rd 10 x 1/10	10,25	38	14	9,84	351401001	341,78
Rd 11 x 1/10	11,25	38	14	10,84	351401002	341,78
Rd 12 x 1/10	12,25	38	14	11,84	351401003	341,78
Rd 14 x 1/8	14,32	45	18	13,82	351401004	385,88
Rd 16 x 1/8	16,32	45	18	15,82	351401005	385,88
Rd 18 x 1/8	18,32	45	18	17,82	351401006	385,88
Rd 20 x 1/8	20,32	55	22	19,82	351401007	529,20
Rd 22 x 1/8	22,32	55	22	21,82	351401008	529,20
Rd 24 x 1/8	24,32	55	22	23,82	351401009	529,20
Rd 26 x 1/8	26,32	65	25	25,82	351401010	663,71
Rd 28 x 1/8	28,32	65	25	27,82	351401011	663,71
Rd 30 x 1/8	30,32	65	25	29,82	351401012	663,71
Rd 32 x 1/8	32,82	65	25	31,82	351401013	663,71

RMS	D1	D2	L1	L2	□	✎	No.	€
W 0,8 x 36	20,35	16,0	80	18	12,0	19,45	360501001	*

* on request

RMS	D	D1	H	D2	No.	€
W 0,8 x 36	20,35	45	14	20,00	361401002	*

* on request

MINI

Metric Mini-thread and Nono-thread

Efficient internal thread cutting in clock and watch industry as well as apparatus construction and fine mechanics.

For through and blind holes. Very break-proof.

Suitable for automatic lathe and tapping machine.

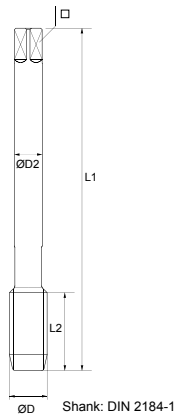

Machine Tap for general use

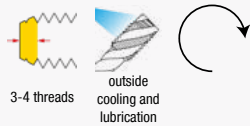
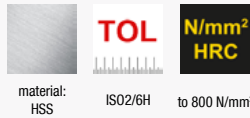
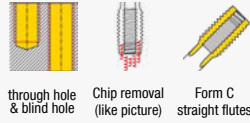
MINI

	D1	D2	L1	L2			No.	packing unit [PU]	€ per PU
M 0,3 x 0,08	0,3	1,0	22	2	0,2	0,24	370501001	10 pieces	*
M 0,35 x 0,09	0,4	1,0	22	2	0,3	0,28	370501002	10 pieces	*
M 0,4 x 0,1	0,4	1,0	22	2,5	0,3	0,32	370501003	10 pieces	*
M 0,5 x 0,125	0,5	1,0	22	3	0,4	0,40	370501004	10 pieces	*
M 0,6 x 0,15	0,6	1,0	22	3,5	0,5	0,49	370501005	10 pieces	*
M 0,7 x 0,175	0,7	1,5	25	4,5	0,6	0,57	370501006	10 pieces	*
M 0,8 x 0,2	0,8	1,5	25	5	0,7	0,65	370501007	10 pieces	*
M 0,9 x 0,225	0,9	1,5	25	5,5	0,8	0,73	370501008	10 pieces	*
M 1 x 0,15	1,0	1,5	25	6	0,9	0,89	370501009	10 pieces	*
M 1 x 0,2	1,0	1,5	25	6	0,9	0,85	370501010	10 pieces	*
M 1 x 0,25	1,0	1,5	25	6	0,8	0,81	370501011	10 pieces	*
M 1,1 x 0,25	1,1	1,5	25	7	0,9	0,91	370501012	10 pieces	*
M 1,2 x 0,15	1,2	1,5	25	7	1,1	1,09	370501013	10 pieces	*
M 1,2 x 0,2	1,2	1,5	25	7	1,1	1,05	370501014	10 pieces	*
M 1,2 x 0,25	1,2	1,5	25	7	1,0	1,01	370501015	10 pieces	*
M 1,3 x 0,3	1,3	1,5	25	8	1,1	1,07	370501016	10 pieces	*
M 1,4 x 0,2	1,4	2,0	30	9	1,3	1,25	370501017	10 pieces	*
M 1,4 x 0,25	1,4	2,0	30	9	1,2	1,21	370501018	10 pieces	*
M 1,4 x 0,3	1,4	2,0	30	8,5	1,2	1,17	370501019	10 pieces	*
M 1,5 x 0,3	1,5	2,0	30	10	1,3	1,27	370501020	10 pieces	*
M 1,6 x 0,2	1,6	2,0	30	10	1,5	1,45	370501021	10 pieces	*
M 1,6 x 0,25	1,6	2,0	30	10	1,4	1,41	370501022	10 pieces	*
M 1,6 x 0,35	1,6	2,0	30	10	1,3	1,30	370501023	10 pieces	*
M 1,7 x 0,35	1,7	2,0	30	10	1,4	1,40	370501024	10 pieces	*
M 1,8 x 0,2	1,8	2,0	30	10	1,7	1,65	370501025	10 pieces	*
M 1,8 x 0,25	1,8	2,0	30	10	1,6	1,61	370501026	10 pieces	*
M 1,8 x 0,35	1,8	2,0	30	10	1,5	1,50	370501027	10 pieces	*
M 2 x 0,2	2,0	3,0	35	13	1,9	1,85	370501028	10 pieces	*
M 2 x 0,25	2,0	3,0	35	13	1,8	1,81	370501029	10 pieces	*
M 2 x 0,4	2,0	3,0	35	13	1,7	1,65	370501030	10 pieces	*
M 2,2 x 0,45	2,2	3,0	35	13	1,8	1,80	370501031	10 pieces	*
M 2,3 x 0,4	2,3	3,0	35	13	2,0	1,95	370501032	10 pieces	*
M 2,4 x 0,45	2,4	3,0	40	15	2,0	2,00	370501033	10 pieces	*
M 2,5 x 0,45	2,5	3,0	40	15	2,1	2,10	370501034	10 pieces	*
M 2,6 x 0,45	2,6	3,0	40	15	2,2	2,20	370501035	10 pieces	*

Camera-Tripod

Camera tripod & C-Mount thread / DIN 4503

Efficient internal thread cutting.

The short structural type makes that tap usable by hand.

The Short-Machine-Tap is also usable by machine.

A Hand-Tap-Set includes 2 taps:

Taper Tap

Finish Tap

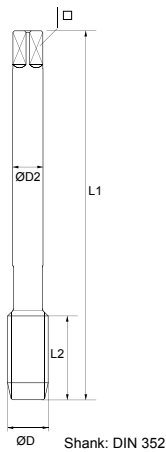

Short Machine Taps Form D for through holes and blind holes

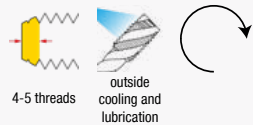
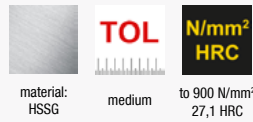
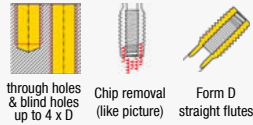

Hand Tap Sets for general use

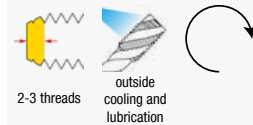
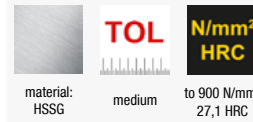
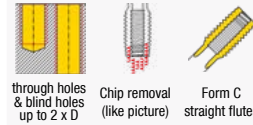

Camera

	D1	D2	L1	L2	□		No.	€	No.	€
Cam.-Tripod 1/4"	6,35	6,0	50	19	4,9	5,20	380101001	30,54		
Cam.-Tripod 3/8"	9,53	7,0	70	24	5,5	8,00	380101002	42,56		
C-Mount 1" x 32	25,40	18,0	130	45	14,0	23,75	380101003	406,82		
S-Mount 12 x 0,5	12,00	9,0	70	22	7,0	11,50			380301004	104,72

Round Dies for general use



material: HSS medium



Chamfer: 1,75 threads right hand thread

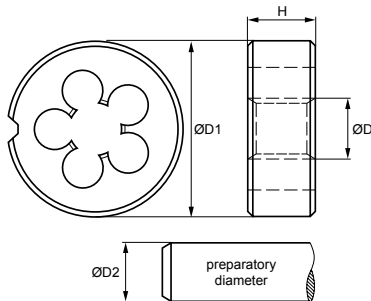

Camera

	D	D1	H	D2	No.	€
Camera-Tripod 1/4"	6,35	20	7	6,22	381401001	39,47
Camera-Tripod 3/8"	9,53	20	7	9,37	381401002	52,92
C-Mount 1" x 32	25,40	55	16	25,25	381401003	285,00
S-Mount 12 x 0,5	12,00	38	10	11,92	381401004	105,12

VG Valve thread / DIN 7756

Efficient internal thread cutting.

The short structural type makes that tap usable by hand.

The Short-Machine-Tap is also usable by machine.

A Hand-Tap-Set includes 2 taps:

Taper Tap

Finish Tap

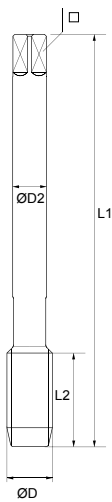

Short Machine Taps Form D for through holes and blind holes

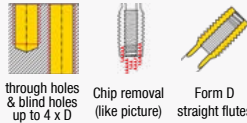

material: HSSG **TOL** **N/mm² HRC**
medium to 900 N/mm² 27,1 HRC

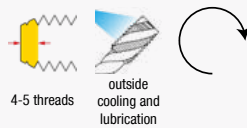

Hand Tap Sets for general use

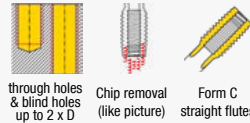

material: HSSG **TOL** **N/mm² HRC**
medium to 900 N/mm² 27,1 HRC

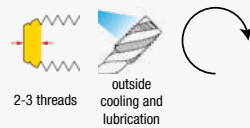

Short Machine Taps Form C for through holes and blind holes

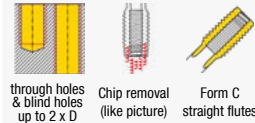

material: HSSG **TOL** **N/mm² HRC**
medium to 900 N/mm² 27,1 HRC

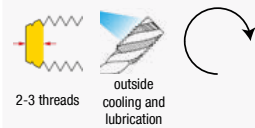

VG

	D1	D2	L1	L2			No.	€	No.	€	No.	€
DIN 2181												
VG 5 x 36	5,15	6,0	50	12	4,9	4,65	390101001	81,86	390301001	278,52		
VG 5,2 x 24	5,23	6,0	56	17	4,9	4,25	390101002	81,86	390301002	255,32		
VG 6 x 32	5,98	6,0	56	14	4,9	5,35	390101003	91,30	390301003	290,14		
VG 8 x 32	7,68	7,0	56	16	5,5	6,90	390101004	93,19	390301004	324,95		
VG 10 x 28	10,27	8,0	63	18	6,2	9,35	390101005	100,75	390301005	348,16		
VG 12 x 26	12,17	9,0	70	22	7,0	11,15	390101006	113,34	390301006	235,17		
DIN 374												
VG 5 x 36	5,15	6,0	70	12	4,9	4,65			390501001	81,86		
VG 5,2 x 24	5,23	6,0	80	17	4,9	4,25			390501002	81,86		
VG 6 x 32	5,98	7,0	80	14	5,5	5,35			390501003	91,30		
VG 8 x 32	7,68	8,0	80	16	6,2	6,90			390501004	93,19		
VG 10 x 28	10,27	8,0	90	18	6,2	9,35			390501005	100,75		
VG 12 x 26	12,17	9,0	100	22	7,0	11,15			390501006	113,34		

Round Dies for general use

 material:
HSS

medium

 Chamfer:
1,5 threads

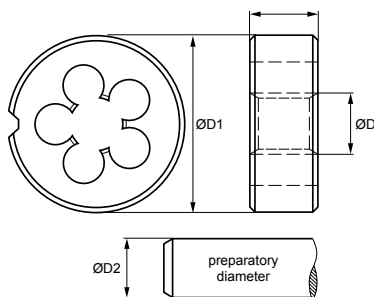
 right hand
thread

VG

	D	D1	H	D2	No.	€
VG 5 x 36	5,15	20	7	5,15	391401001	45,34
VG 5,2 x 24	5,23	20	7	5,23	391401002	45,34
VG 6 x 32	5,98	20	7	5,98	391401003	45,34
VG 8 x 32	7,68	25	9	9,60	391401004	64,23
VG 10 x 28	10,27	30	11	10,27	391401005	89,42
VG 12 x 26	12,17	30	11	12,17	391401006	89,42

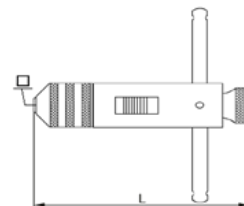
BAER Tap holders with ratchet



for taps

size	metric	inch-sizes	□	L1	No.	€
1	M 3 - M 10	1/8 - 3/8	2,4 - 5,5	85	491625001	10,68
2	M 5 - M 12	7/32 - 1/2	4,5 - 8,0	100	491625002	13,20
10	M 3 - M 10	1/8 - 3/8	2,4 - 5,5	250	491625010	17,60
20	M 5 - M 12	7/32 - 1/2	4,5 - 8,0	300	491625020	21,37



Adjustable Pro Tap Wrenches - Premium zinc die cast

for taps

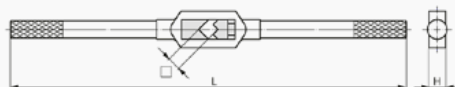

size	metric	inch-sizes	pipe-threads	□	L1	No.	€
0	M 1 - M 8	1/16 - 1/4		2,0 - 5,0	130	491725000	5,40
1	M 1 - M 10	1/16 - 3/8	G 1/8	2,0 - 6,3	176	491725010	5,79
1.1/2	M 1 - M 12	1/16 - 1/2	G 1/8	2,1 - 8,0	176	491725015	5,79
2	M 4 - M 12	5/32 - 1/2	G 1/8	3,0 - 9,0	280	491725020	11,10
3	M 5 - M 20	7/32 - 3/4	G 1/8 - G 1/2	4,9 - 12	380	491725030	19,60
4	M 11 - M 27	7/16 - 1"	G 1/4 - G 3/4	5,5 - 16	505	491725040	31,50
5	M 13 - M 32	1/2 - 1.1/4	G 1/4 - G 1"	7,0 - 20	700	491725050	45,00
6	M 18 - M 42	3/4 - 1.1/2	G 1/2 - 1.1/4"	11,0 - 24	1000	491725060	99,50

Adjustable Tap Wrenches - steel



for taps

	metric	inch-sizes	pipe-threads	□	L1	No.	€
0	M 1 - M 8	1/16 - 1/4		2,0 - 5,0	130	491724000	7,87
1	M 1 - M 10	1/16 - 3/8		2,0 - 6,3	180	491724010	9,03
1.1/2	M 1 - M 12	1/16 - 1/2	G 1/8	2,1 - 8,0	205	491724015	9,03
2	M 4 - M 12	5/32 - 1/2	G 1/8	3,0 - 9,0	280	491724020	16,16
3	M 5 - M 20	7/32 - 3/4	G 1/8 - G 1/2	4,9 - 12	380	491724030	30,96
4	M 11 - M 27	7/16 - 1"	G 1/4 - G 3/4	5,5 - 16	500	491724040	54,57
5	M 13 - M 32	1/2 - 1.1/4	G 1/4 - G 1"	7,0 - 20	700	491724050	64,02
6	M 18 - M 42	3/4 - 1.1/2	G 1/2 - G 1.1/4	11 - 24	1000	491724060	107,05
7	M 27 - M 52	1.1/8 - 2"	G 3/4 - G 1.3/4	16 - 32	1250	491724070	119,64
8	M 27 - M 64	1.1/8 - 3"	G 3/4 - G 3"	16 - 40	1250	491724080	289,65

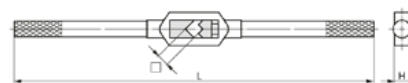

Die Stocks Pro - Premium zinc die cast



For Round Dies

∅ D x H	metric	inch-sizes	L1	No.	€
16 x 5	M 1 - M 2,6	BSW 1/16 - BSW 3/32	160	491825001	4,21
20 x 5	M 3 - M 4	BSW 1/8 - BSW 5/32	200	491825002	4,74
20 x 7	M 4.5 - M 6	BSW 3/16 - BSW 1/4	200	491825003	4,74
25 x 9	M 7 - M 9	BSW 5/16	224	491825004	5,40
30 x 11	M 10 - M 11	BSW 3/8 - BSW 7/16	280	491825005	7,37
38 x 10	MF 12 - MF 15	G 1/4	315	491825006	11,84
38 x 14	M 12 - M 14	BSW 1/2 - BSW 9/16	315	491825007	11,84
45 x 14	MF 16 - MF 20	G 3/8-1/2	450	491825008	16,18
45 x 18	M 16 - M 20	BSW 5/8 - BSW 13/16	450	491825009	16,18
55 x 16	MF 22 - MF 26	G 5/8 - G 3/4	560	491825010	21,70
55 x 22	M 22 - M 24	BSW 7/8 - BSW 1"	560	491825011	21,70
65 x 18	MF 27 - MF 36	G 7/8 - G 1"	630	491825012	31,05
65 x 25	M 27 - M 36	BSW 1.1/8 - BSW 1.3/8	630	491825013	31,05

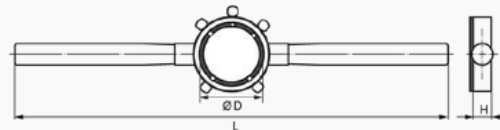

Die Stocks - zinc die cast



For Round Dies

∅ D in inch	∅ D (mm) x H (mm)	∅ D (inch) x H (inch)	L1	No.	€
13/16"	20,6 x 6,35	13/16 x 1/4	200	491823014	3,78
1"	25,4 x 9,5	1" x 3/8	224	491823015	4,62
1.5/16"	33,4 x 11,1	1.5/16 x 7/16	270	491823016	7,98
1.1/2"	38,1 x 12,7	1.1/2 x 1/2	315	491823017	12,17
2"	50,8 x 15,9	2" x 5/8	560	491823018	19,73
2.1/4"	57,1 x 17,5	2.1/4 x 11/16	560	491823019	20,99
2.1/2"	63,5 x 19,0	2.1/2 x 3/4	630	491823020	27,71
3"	76,2 x 22,2	3" x 7/8	900	491823021	81,86
3.1/2"	88,9 x 25,4	3.1/2" x 1"	900	491823022	97,60
4"	101,6 x 25,4	4" x 1"	1000	491823023	240,54

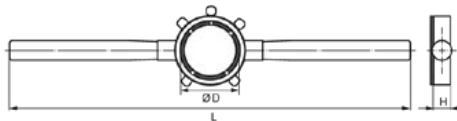

Die Stocks - steel

For Round Dies

∅ D x H	metric	inch-sizes	L1	No.	€
45 x 18	M 16 - M 20	BSW 5/8 - BSW 13/16	450	491824001	27,71
55 x 22	M 22 - M 24	BSW 7/8 - BSW 1"	560	491824002	39,04
65 x 25	M 27 - M 36	BSW 1.1/8 - BSW 1.3/8	630	491824003	49,12
75 x 20	MF 38 - MF 42	G 1.1/8 - G 1.1/4	800	491824004	80,60
75 x 30	M 38 - M 42	BSW 1.1/2 - BSW 1.5/8	800	491824005	80,60
90 x 22	MF 45 - MF 52	G 1.3/8 - G 1.5/8	900	491824006	103,27
90 x 36	M 45 - M 52	BSW 1.3/4 - BSW 2"	900	491824007	103,27
105 x 22	MF 54 - MF 63	G 1.3/4 - G 2"	975	491824008	123,42
105 x 36	M 54 - M 63	BSW 2.1/4	975	491824009	123,42
120 x 22	MF 64 - MF 71	G 2.1/4 - G 2.3/4	956	491824010	352,62
120 x 36	M 64 - M 71	BSW 2.1/2 - BSW 2.3/4	956	491824011	352,62
130 x 25		G 3"	966	491824012	440,78
130 x 36			966	491824013	440,78
140 x 22			976	491824014	566,72
150 x 25		G 3.1/2"	986	491824015	623,39
160 x 25		G 4"	996	491824016	856,37

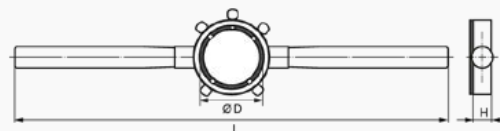

Extension sleeves for taps



	L1	for taps metric acc. to DIN 352	No.	€
2,1	60	M 1 - M 2,6	491925021	3,15
2,4	70		491925024	3,15
2,7	80	M 3	491925027	3,57
3,0	90	M 3,5	491925030	3,57
3,4	95	M 4	491925034	4,09
3,8	100		491925038	4,62
4,3	105		491925043	4,83
4,9	110	M 4,5 - M 8	491925049	5,04
5,5	115	M 9 - M 10	491925055	5,04
6,2	120	M 11	491925062	5,67
7,0	125	M 12	491925070	6,40
8,0	125		491925080	8,71
9,0	130	M 14 - M 16	491925090	9,34
10,0	140		491925100	9,97
11,0	150	M 18	491925110	12,07
12,0	155	M 20	491925120	15,74
13,0	165		491925130	17,84
14,5	175	M 22 - M 24	491925145	22,04
16,0	180	M 27	491925160	23,09
18,0	200	M 30	491925180	27,29
20,0	220	M 33	491925200	35,16
22,0	220	M 36	491925220	48,28
24,0	235	M 39 - M 42	491925240	62,97
26,0	250		491925260	81,86
29,0	265	M 45 - M 48	491925290	96,55
32,0	285	M 52	491925320	136,43

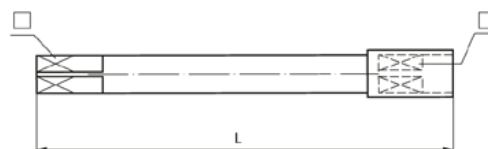

Pro Die Guides M 3 - M 12

for Round Dies DIN 223 = EN 22568 and
Die Stocks DIN 225 = EN 22568

Application:

- ⚙️ The guide helps cutting an external thread with cutting dies. The guides will be laid together with the cutting dies into the die holder.

Advantages:

- ✔️ made of free-cutting steel with an oxidized surface
- ✔️ accurate aligned threads
- ✔️ clear thread flanks
- ✔️ less deficient products
- ✔️ better evacuation of the chip, because of the leading with clearance holes
- ✔️ able to cut right- or left-hand threads as well as all possible pitches



19,43 €

Item No.:
492025312

Net prices without VAT or tax



13,01 € 100 ml
Item No.: SP100

BAER High Performance cutting paste

Cutting paste with high pressure additives achieves extremely high lubricity. The paste adhering to the cutting edges only gets liquid when used (use cutting paste undiluted).

Lubrication is important for chip removal processes.

Advantages:

- ✓ Contains no petroleum, chlorine or sulfur
- ✓ Significantly improved tool life time
- ✓ Does not leave a greasy film of oil on the workpiece

Application:

- ⚙ Drilling, tapping, thread milling, reaming, milling, core drilling, sawing, as well as for heavy chipping and for all machining operations.

For all steels such as: iron, steel, tool steel, high alloy steels, chromium-nickel alloys, Aluminum, titanium, manganese, cast steel, cast iron, brass, bronze and all stainless steels AISI 304, AISI 316, INOX etc.

BAER Countersink

**HSSG 90°
Countersink**
for general use



**HSSE-VAP 90°
Countersink**
for stainless
steels



**HSSG-Bit 90°
Countersink**
for electric screw
drivers



dimension	No.	€	No.	€	No.	€
6,3 mm (M 3)	74563	6,81	74663	13,51	744063	6,16
8,3 mm (M 4)	74583	8,17	74683	15,77	744083	6,48
10,4 mm (M 5)	745104	9,07	746104	18,14	744104	8,26
12,4 mm (M 6)	745124	11,35	746124	21,55	744124	9,59
16,5 mm (M 8)	745165	15,82	746165	35,38	744165	13,18
20,5 mm (M 10)	745205	22,00	746205	45,02	744205	16,96
25,0 mm (M 12)	745250	30,39	746250	56,71		
31,0 mm (M 16)	745310	56,24	746310	105,46		
Set 6,3 8,3 10,4 12,4 16,5 20,5 mm*	1571	92,43	1573	165,57	1576	68,04
Set 6,3 10,4 16,5 20,5 25,0 mm*	1572	105,23	1574	187,11		



* picture of sets

Tap Geometries

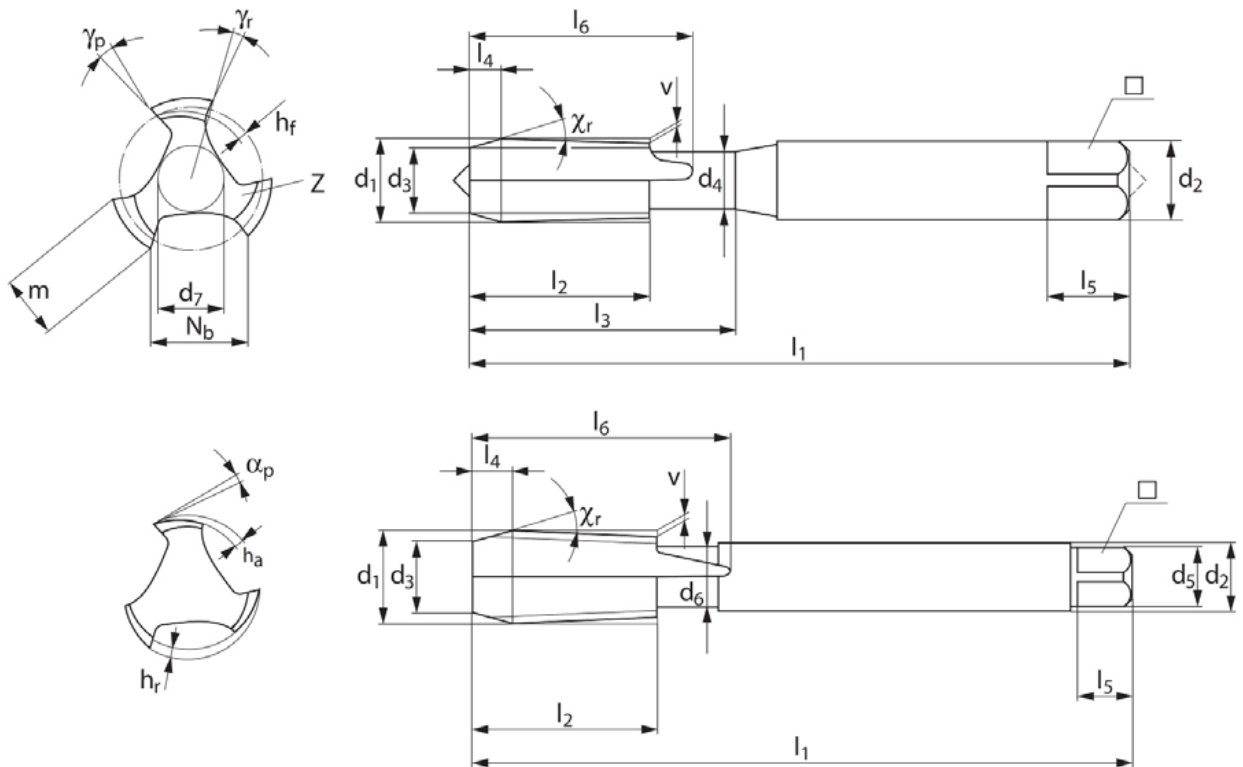

d1	Thread diameter	Z	Number of flutes
d2	Shank diameter	v	Back taper (axial relief)
d3	Chamfer diameter	xr	Chamfer angle
d4	Neck diameter	Nb	Width of flute
d5	Recessed square diameter	m	Width of land
d6	Neck diameter	ha	Chamfer relief
d7	Web diameter	hf	Relief on flanks
l1	Total length	hr	Chamfer relief
l2	Thread length	α_p	Relief angle
l3	Useful length	γ_p	Rake angle
l4	Chamfer lead length		
l5	Square length		
l6	Flute length		
<input type="checkbox"/>	Square dimension		

Tap Centering



Tap Construction dimensions

	DIN 352	DIN 2181	DIN 5157	DIN 40432
Gewindebohrer / Tap				
	DIN 371	DIN 40435		
Gewindebohrer / Tap				
	DIN 376	DIN 374	DIN 5156	DIN 40433
Gewindebohrer / Tap				DIN 40435
	DIN 2174	DIN 371		
Gewindeformer / Forming Tap				
	DIN 2174	DIN 376	DIN 2189	
Gewindeformer / Forming Tap				

Tap Chamfer Forms

	Form A long, 6 - 8 thread straight flutes for short through holes
	Form B medium, 3,5 - 5,5 threads straight flutes with spiral point for through holes in medium- and long chipping materials
	Form C short, 2 - 3 threads straight and spiral flutes for blind holes in medium- and long chipping materials for through holes in short chipping materials
	Form D medium, 3,5 - 5 threads straight and spiral flutes 15° for blind holes with long thread runout for short through holes
	Form E very short, 1,5 - 2 threads straight and spiral flutes 15° for blind holes with short thread runout
	Form F very short, 1 - 1,5 threads straight and spiral flutes for blind holes with short thread runout Avoid if possible.

Please note:

Short chamfers cut threads close to the bottom of the borehole.

Long chamfers reduce the forced on the cutting edges (recommended for materials with higher material strength)

Long chamfers increase the required torque.

Tap flutes

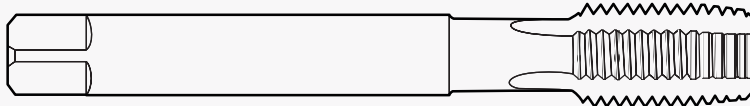

Form A, C, E
straight-fluted
for through and blind holes

The flutes can hold a part of the chips. Chips get only partially removed in cutting direction. For this reason it is not recommended to use the tap for deep holes.

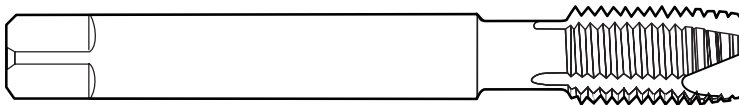

Form B
straight-fluted with spiral point
for through holes

Due to the spiral point the chips are getting removed tightly rolled in cutting direction and prevents chip-packing. Coolant-lubricant can flow freely.

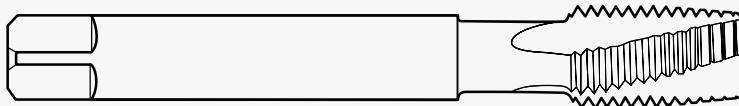

Form C, D
8 - 15° left-hand spiral flutes
for through holes

Due to the left-hand spiral flutes the rake angle remains constant and ensure stable chamfer teeth to produce threads in high-strength materials. The left-hand spiral flutes forces the chips to remove ahead of the tap.

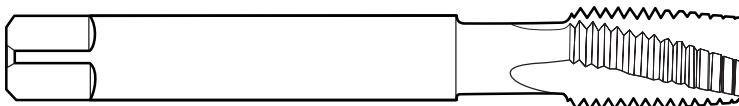

Form C, E
10 - 15° right-hand spiral flutes
for blind holes

Especially suitable for automatic lathes and multi-spindle machines. Due to the chip removal against the cutting direction a secured tapping process is assured in hard conditions, even for threads with cross holes.

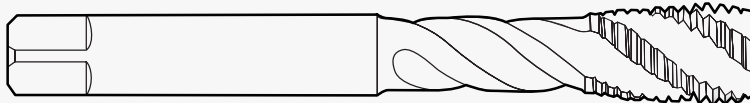

Form C, E
35 - 50° right-hand spiral flutes
for blind holes

Due to the high spiral flutes, the chips can be removed securely also in long-chipping and deep blind holes.

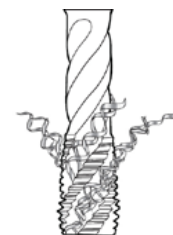

Tolerances

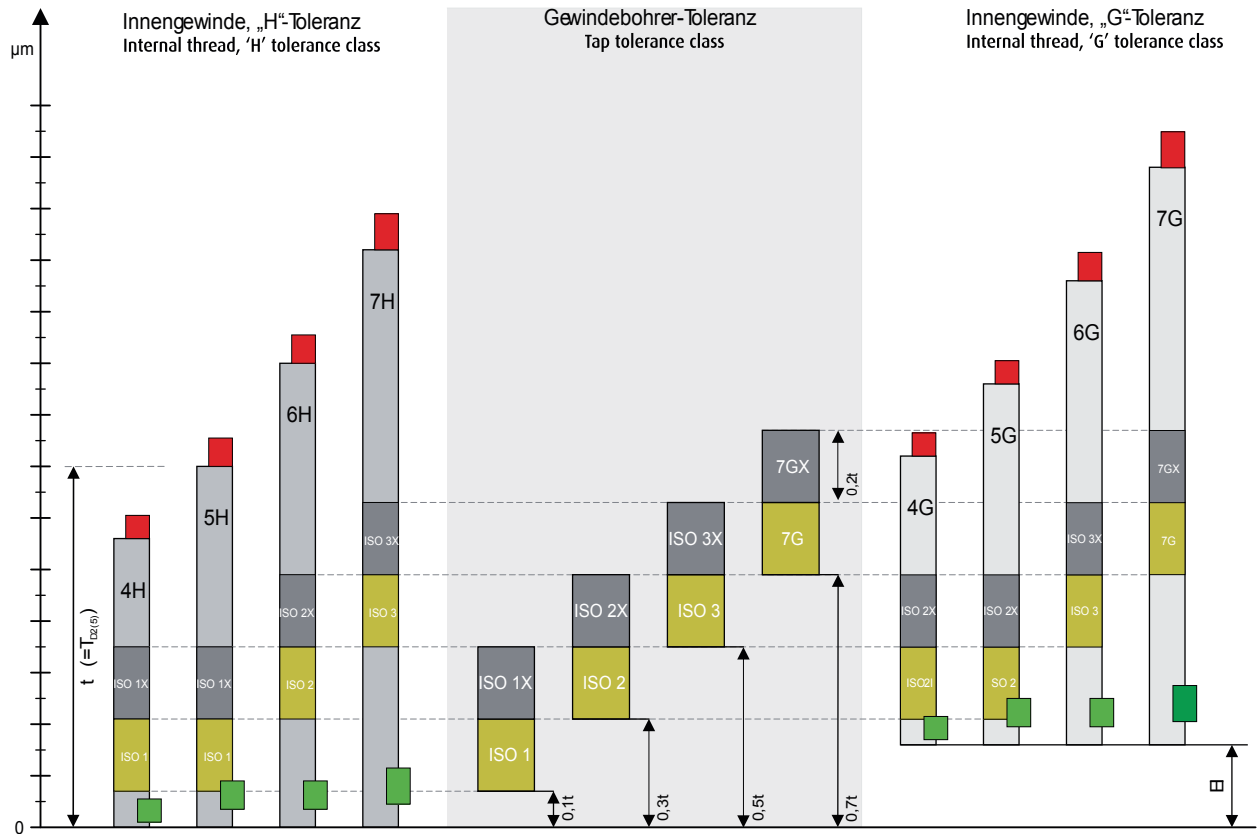

- Flankendurchmesser-Toleranz des Innengewindes nach DIN ISO 965-1
Pitch diameter tolerance of internal thread acc. DIN ISO 965-1
- Gewindebohrer mit spezieller Flankendurchmesser-Toleranz
Taps with specific pitch diameter tolerance
- Flankendurchmesser-Toleranz des Gewindebohrers nach DIN EN 22857
Pitch diameter tolerance of the tap acc. DIN EN 22857
- Flankendurchmesser-Toleranz des Ausschusslehrdorns nach DIN ISO 1502
Pitch diameter tolerance of the no-go thread plug gauge acc. DIN ISO 1502
- Flankendurchmesser-Toleranz des Gutlehdorns nach DIN ISO 1502
Pitch diameter tolerance of the go thread plug gauge acc. DIN ISO 1502

- EI = Grundmaß
Basis
- t = Toleranzklasse 5 des Innengewindes (Toleranzeinheit)
Tolerance class of the internal thread (tolerance unit)
- TD2 = Toleranz des Flankendurchmessers
Pitch diameter tolerance

tolerance class of tap	tolerance field internal thread	remarks	Applications
4H (DIN 802/1)	ISO 1 4H 5H	undersize	Threads with small clearance
6H (DIN 802/1)	ISO 2 4G 5G 6H	normal	Thread with normal clearance
6G (DIN 802/1)	ISO 3 6G 7H 8H	oversize	Threads with large clearance
7G (DIN 802/4)	7G 8G	oversize	before heat treatment, causing distortion
6H +0,1		oversize	Electroplating allowance ≈ 25µm thickness
6H +0,2		oversize	Electroplating allowance ≈ 50µm thickness

Tap Surface Treatments



TIN (titanium nitride) coating

The TIN surface treatment (titanium-nitride gold-yellow) increases the surface hardness (approx. 2300 HV) and the sliding properties. It provides a better cutting performance and increased tool life time.



VAP (vaporized - steam tempered)

The oxide surface (vaporized) improves the adhesion of the cutting oil and provides a stabil lubricant film. Cold welding in the tap flanks is reduced.



TiAlN (titanium aluminium nitride) coating

The TiAlN surface treatment increases the surface hardness (approx. 3300 HV), the sliding properties (friction coefficient: 0,25) and with high temperature resistance up to 800°C. It provides a better cutting performance and increased tool life time.



TiCN (titanium carbonitride) coating

The TiCN surface treatment (titanium carbon nitride - grey violet) increases the surface hardness (approx. 3000 HV) and the sliding properties (coefficient of friction: 0,3). It provides a better cutting performance and increased tool life time.

Coating services

Every threading tool of our product range - whether or not cataloged - can be delivered with any coating or surface treatment in short time.

Tapping undersized threads	<ul style="list-style-type: none"> Pitch error Too small tolerance Geometry of the tap is not suitable for the material
Tapping oversized threads	<ul style="list-style-type: none"> Cutting speed is too high Bad running accuracy Chip jammings in flutes Incorrect positioning of workpiece or tap Inconsistent feed of tap Too high tolerance
Poor thread surface	<ul style="list-style-type: none"> Cutting speed not suitable Cooling is not suitable or not existing Geometry of the tap is not suitable for the material Core hole too small
Thread break of the thread to be cut	<ul style="list-style-type: none"> Geometry of the tap is not suitable for the material Core hole too small Core hole not deep enough Chip jammings in flutes Bad running accuracy Incorrect positioning of workpiece or tap Inconsistent feed of tap
Low tap lifetime	<ul style="list-style-type: none"> Cutting speed not suitable Cooling is not suitable or not existing Geometry of the tap is not suitable for the material Surface treatment/ coating for tap needed Core hole too small Geometry of the tap is not suitable for the material Core hole too small Core hole not deep enough Chip jammings in flutes
Tool outbreaks	<ul style="list-style-type: none"> Bad running accuracy Incorrect positioning of workpiece or tap Inconsistent feed of tap Worn tap
Cold welding on the tap	<ul style="list-style-type: none"> Cutting speed not suitable Increase coolant supply

Tap Cutting speeds

The cutting speeds for taps depend on following parameters:

- ✓ material of the workpiece
- ✓ tap geometries
- ✓ lubrication
- ✓ and more.

You can find the cutting speed in the product descriptions of the taps in our online-shop. Just enter the item number into the Search-field and find the cutting speeds in the bottom part of the product description.

Lubrication and cooling

It is recommended to use one of the following coolings or lubrications to improve the thread results and tool life time.

Dry machining and pressurized air

- ✓ cast iron
- ✓ (Cooled) pressurized air is used for chip removal

Emulsion

- ✓ Most common coolant-lubricant for thread cutting

Thread cutting oil

- ✓ Achieving excellent thread surfaces and tool life time

Thread cutting paste

- ✓ suitable for forming taps
- ✓ good results with horizontal cutting direction
- ✓ for bigger diameters and through holes

MQL - Minimum-quantity lubrication

- ✓ cooling by aerosol

Formula

Description	Symbol	Unit	Formula	Example
Rotation speed	n	min ⁻¹		
Angular speed	ω	s ⁻¹	$\omega = \frac{2 \cdot \pi \cdot n}{60}$	n = 400 min ⁻¹ $\omega = \frac{2 \cdot \pi \cdot 400}{60}$ $\omega = 41,89 \text{ s}^{-1}$
Cutting speed	v _c	m/min	$v_c = \frac{d \cdot \omega}{33,3}$ $v_c = \frac{d \cdot \pi \cdot n}{1000}$	n = 400 min ⁻¹ , d = 20 mm $v_c = \frac{20 \cdot \pi \cdot 400}{1000}$ v _c = 25,133 m/min
Feed per revolution	f	mm		
Feed speed	v _f	mm/min	v _f = f · n	n = 400 min ⁻¹ f = 0,800 mm v _f = 0,800 · 400 v _f = 320 mm/min
Force	F	N	F = k _c · A	
Torque	M	Nm	$M = \frac{F \cdot d}{2000}$	F = 200 N, d = 20 mm $M = \frac{200 \cdot 20}{2000}$ M = 2 Nm
Mechanical work	W	J	W = F · U	F = 200 N, d = 20 mm $U = \frac{d \cdot \pi}{1000} = 0,063 \text{ m}$ W = 200 · 0,063 = 12,6 J
Performance	P	W	$P = \frac{F \cdot v_c}{60}$ P = M · ω	F = 200 N, v _c = 25,133 m/min P = 83,78 W M = 2 Nm, ω = 41,89 s ⁻¹ P = 83,78 W
Efficiency	η	-	$\eta = \frac{P_{ab}}{P_{an}}$ η < 1	P _{ab} = 58,65, P _{an} = 83,78 W $\eta = \frac{58,65}{83,78} = 0,7$

π = 3,141592654

d = Diameter in mm

U = circumference in m

1 kW = 1,36 PS

1 PS = 0,736 kW

$1 \frac{\text{m}}{\text{s}} = 60 \frac{\text{m}}{\text{min}}$

1/s = 60/min = 1 Hz

$1 \text{ J} = 1 \text{ Nm} = 1 \frac{\text{kg} \cdot \text{m}^2}{\text{s}^2}$

$1 \text{ W} = 1 \frac{\text{J}}{\text{s}} = 1 \frac{\text{Nm}}{\text{s}} = 1 \frac{\text{kg} \cdot \text{m}^2}{\text{s}^3}$

Round Dies Geometries

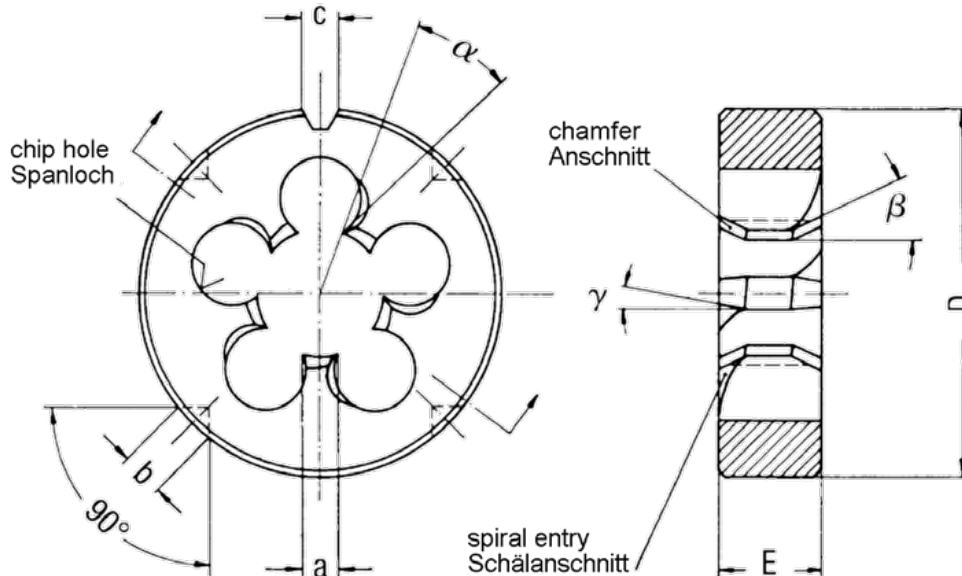

D outside diameter
E thickness
a width of tooth
c width of notch

b diameter of hole for fixing screw
 α rake angle
 β chamfer angle
 γ spiral angle

Preparation of workpiece:

- ☑ concentric chamfer - ease entry of cutting
- ☑ workpiece diameter must be less than the nominal diameter

Chamfer

- ☑ Standard chamfer (length, see at the item)
- ☑ Spiral entry: free flow of chips ahead of the die and a reducing of cutting torque.

This result in an improved surface finish on the cut threads and longer die life

- ☑ 70° (short chamfer) - chamfer length: 1,25 pitch = 70°

Tolerances for Round Dies

Metric ISO thread acc. DIN 13 - coarse and fine thread

4h = tolerance class „fine“

6h = tolerance class „middle“, for small diameters (up to M 1,4)

6g = tolerance class „middle“ - Standard

6e = undersize tolerance; for bolts that receive a surface treatment or a galvanizing (layer thickness up to 8 μm).

Cutting dies with 6e tolerance are cutting about 0,03 mm smaller than normal cutting dies with 6g tolerance.

8e = undersize tolerance; for bolts that receive a strong surface coating (layer thickness about 16 - 18 μm)

Unified thread UNC, UNF, UNEF, UNS, UN, UNJC, UNJF etc.

3A = tolerance „fine“

2A = standard tolerance „middle“

1A = tolerance „coarse“

Whitworth pipe thread G (BSP) acc. DIN-ISO 228

A = standard tolerance „middle“

B = tolerance „coarse“

Cutting speeds for Machine Forming Taps

materials	tensile strength	forming speed in m/min	recommended lubrication
construction steels, free-machining steels, cold-extrusion steels etc.	< 600 N/mm ²	20 - 80	Cutting oil/ Emulsion
construction steels, heat-treatable steels, cast steels etc.	< 800 N/mm ²	20 - 60	Cutting oil/ Emulsion
heat-treatable steels, cold-extrusion steels, nitriding steels etc.	< 1000 N/mm ²	10 - 40	Cutting oil
corrosion and acid proof steels ferritic, martensitic	< 950 N/mm ²	10 - 25 (with emulsion just limitedly applicable)	Cutting oil
corrosion and acid proof steels austenitic	< 950 N/mm ²	10 - 25 (with emulsion just limitedly applicable)	Cutting oil
aluminium wrought alloys	< 550 N/mm ²	15 - 40	Cutting oil/ Emulsion
aluminium cast alloys	Si < 12%	15 - 40	Cutting oil/ Emulsion
pure copper	< 400 N/mm ²	20 - 40	Cutting oil/ Emulsion
copper-zinc alloys (brass long-chipping)	< 550 N/mm ²	40 - 80	Emulsion

forming (cutting) speed [m/min] = (diameter * π * number of rotation) / 1000

number of rotation n [1/min] = (cutting speed in m/min * 1000) / (diameter * π)

feed programming [mm/min] = number of rotation * pitch

Please notice that the mentioned cutting speeds are only for orientation.

The right cutting speed is depend on lubrication and application.



BAER Vertriebs GmbH
Robert-Bosch-Str. 5
68542 Heddeshheim
Germany
Tel: +49 (0) 6203 4048 790
Fax: +49 (0) 6203 4048 791
E-Mail: info@gewindebohrer.de
www.threading-tools.com









BAER Vertriebs GmbH
Robert-Bosch-Str. 5
68542 Heddesheim
Germany

Tel: +49 (0) 6203 4048 790
Fax: +49 (0) 6203 4048 791
E-Mail: info@gewindebohrer.de
www.threading-tools.com

