



BaerFix[®]

SELF-CUTTING THREAD INSERTS

www.baerfix.com



2022



Precision and Quality

Good quality is the best marketing, because satisfied customers underline our success.

Our most important principle which inspires us is the commitment for products of the highest standards to meet the requirements of our customers to their utmost satisfaction - a mission we try to fulfill for our corporate philosophy every day.

Our quality check starts with the receipt of goods and continues until the outgoing of the products. At BAER Company customer satisfaction does not come by chance. Ongoing quality testings also influence all new product developments. New ideas and the most modern production facilities improve our products and make them even more precise.



Tradition and Experience

For more than 35 years we have been engaged in what we can do best: threading technology. With this far-reaching treasure trove of experience we have established ourselves as an expert by whom our customers can profit. We are proud to be a family company.

Our identification with the company is even stronger and more distinctive. Each customer, each modernization is at the same time an affair of the heart.

Tradition combined with innovation and progress - make us a flexible and competent partner when it is about threading tools.

Our claim: to contribute to a successful future and to develop tools which meet all kinds of requirements of our customers.



Development and Improvement

Essential for the sustainability of our work is to invest continuously the long-term in new innovative products. Highest efforts in research and development focus on the needs of our customers. Our tools represent practical and reliable solutions which support an efficient and easy application.

Our cooperations with other industries, companies and research institutes make a strong networking possible. New inspirations are created in innovations, are produced, tested and adapted for practice.

This way we are always up to the latest standards of knowledge related to thread technologies. All members of our company contribute to our innovations with their individual know-how.



Distributors

For ensure further deliveries to the customer as soon as possible at home and abroad, we are expanding our distributor network. BAER-distributors benefit from:

- The largest full range of products - for best price performance ratio
- Quality and reliability - for the highest demands
- Decades of experience in threading technology
- Reliable partnership - flexible and easy
- Sale supporting materials
- Exclusive products
- Exclusive sale territories
- Qualified product and sales trainings
- Attractive terms and conditions
- Innovative products

BaerFix® Self-tapping Thread Inserts

4 - 9



BaerFix® Thread Repair Kits

10 - 13



BaerFix® Thread Repair Workshop Kits

14 - 17



BaerFix® Inserting Tools

18 - 20



Ø 3.437	4.000	3.975	4.125	4.688	4.563	1.627
Ø 3.780	4.312	4.188	4.500	5.063	4.938	1.782

Technical Data

21 - 23

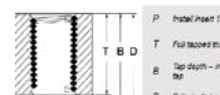

BaerFix® Thread Inserts, self-tapping with cutting slots



BaerFix® Thread Inserts have a conical lead with cutting slots on the metric external thread. They are designed to cut their own threads as they are being driven into a drilled hole (= self-tapping). This provides a secure and high-strength anchor in the parent material. BaerFix® Thread Inserts create wear-free and vibration resistant bolted connections because of its close tolerances and the self-tapped thread. In some cases the Insert has a minimal inward springing action, which creates a screw locking effect. If this is not wished, you can use BaerFix® Thread Inserts with cutting holes. These are suitable for creating highly durable and wear resistant bolted connections in materials with low shear resistance.

BaerFix® Thread Inserts, self-tapping with cutting holes

BaerFix® self-tapping Thread Inserts with cutting holes are constructed especially for materials with difficult machining characteristics. The thick wall allows higher cutting forces, which are distributed over three cutting holes.

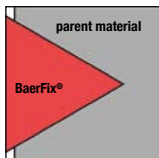

Large effective shearing surface

The BaerFix® Thread Insert has a larger effective surface, which ensures a higher degree of pull-out strength, i.e. an M 5 is often sufficient instead of a cut M 6 thread.

Flange cover

In a work piece made of a light alloy, the BaerFix® Insert achieves almost maximum pull-out strength with only 30 % flange cover.

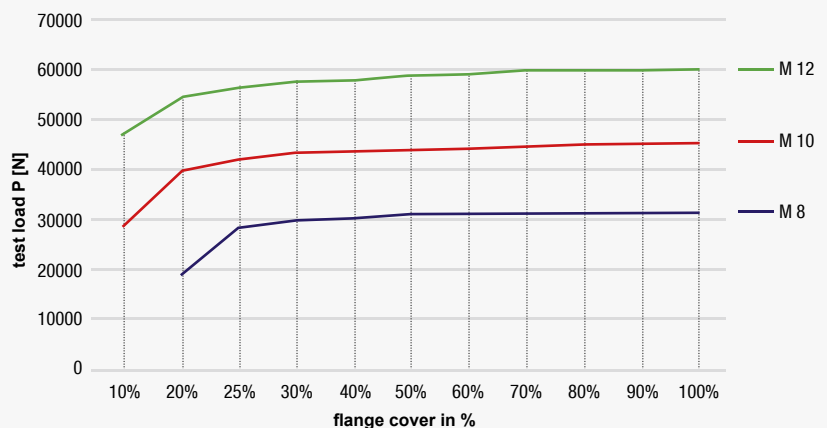
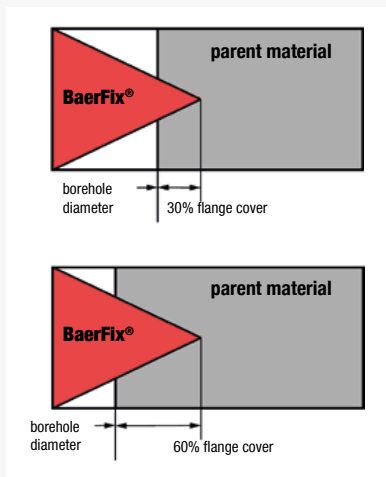

Pull-out strength

A BaerFix® Thread Insert is highly durable. Using in light alloys for example, helps achieving a pull-out strength which far exceeds the yield strength of a screw 8.8.

Corrosion resistance

The superior corrosion resistant characteristics of BaerFix® Inserts assure their adaptability to most materials and usual environmental conditions.

Minimize weight & space

Weight saving is unmatched - an important design feature for many products, particularly airborne equipment. Space saving is maximized, permitting the use of standard configurations with oversize requirements - as is necessary to accommodate solid bushings. A bigger radius equal to the nominal bolt size fit for higher load and forces.

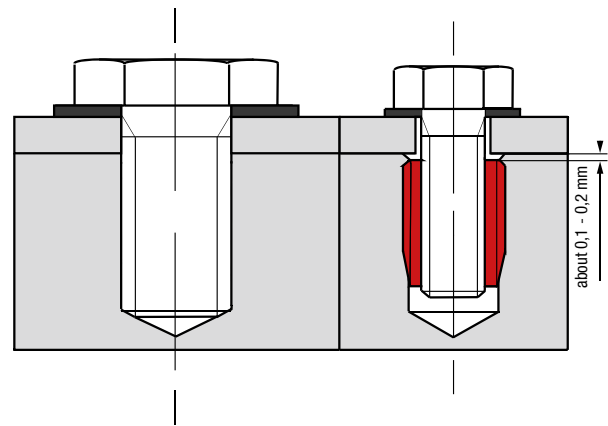

Minimize total costs

Overall production cost savings may be realised by using a less expensive material and still maintain the required thread strength with BaerFix® Inserts. Costs savings apply in many directions - lower insert costs, lower installation costs and smaller bolts do all result savings.



Thread Repair

In addition to thread reinforcement the BaerFix® Inserts also are used for repairing broken threads. In this process rejected components can be reclaimed by installing a thread insert. The created thread will keep its original dimension and also gets reinforced by raising the pull-out strength and corrosion resistance. Costs of acquisition and processing can be saved by repairing threads with BaerFix® Thread Inserts.



Applications

It's especially suitable for following materials:

- aluminum and aluminum alloy
- brass, bronze, cast iron
- magnesium alloy
- hermosetting plastics and thermoplastics (no rubber-soft thermoplastics)

Examples for applications:

- Automotive industry: engines, transmissions, radiators, autobody etc.
- Electrical and laboratory techniques: medical equipment, capacitors, boxes etc.
- Household appliance: vacuum cleaners, electric iron, washing machines, cameras, mobile phones etc.
- Plant and equipment construction: pumps, construction machines, different components etc.
- Military machines: aircrafts, weapons etc.

Materials

Case-hardened steel,
zinc-plated, yellow
chromated (conform to
RoHS, free of ChromVI)

Stainless steel 1.4305

AISI 303

X8CrNiS18-9

Brass

Stainless steel 1.4105*

AISI 430 F

X6CrMoS17

Other materials and surfaces on request.

* on request

Compatibility

BaerFix® Inserts are manufactured according to tolerance ISO 2768-m. BaerFix® products are compatible with thread inserts and tools from other manufactures.

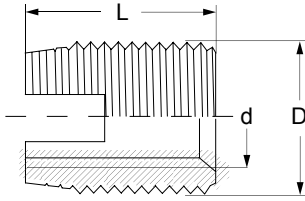

Case-hardened steel, zinc-plated, conform to RoHS



Stainless steel 1.4305 (AISI 303)



Stainless steel 1.4571 (AISI 316Ti)



Brass

d	D	L	No.	pa- cking unit	€ pack. unit	No.	packing unit	€ pack. unit	No.	packing unit	€ pack. unit	No.	pa- cking unit	€ pack. unit
M														
M 2 x 0,4	M 4,5 x 0,5	6 mm	FE02	10	11,16									
			1-FE02	100	42,44									
M 2,5 x 0,45	M 4,5 x 0,5	6 mm	FE025	10	11,28									
			1-FE025	100	42,90									
M 3 x 0,5	M 5 x 0,5	6 mm	FE03	10	4,75	FA43	10	20,70	FAE03	10	36,54	1-FMS43	100	15,00
			1-FE03	100	19,13	1-FA43	100	73,70	1-FAE03	100	110,67			
M 4 x 0,7	M 6,5 x 0,75	8 mm	FE04	10	6,21	FA44	10	20,83	FAE04	10	42,21	1-FMS44	100	20,63
			1-FE04	100	23,85	1-FA44	100	74,45	1-FAE04	100	127,89			
M 5 x 0,8	M 8 x 1,0	10 mm	FE05	10	7,15	FA45	10	20,23	FAE05	10	47,15	1-FMS45	100	26,88
			1-FE05	100	27,09	1-FA45	100	76,40	1-FAE05	100	143,01			
M 6 x 1,0	M 9 x 1,0	12 mm	FE069	10	9,44	FA469	10	20,83	FAE069	10	55,44	1-FMS469	100	36,12
			1-FE069	100	32,26	1-FA469	100	83,88	1-FAE069	100	168,11			
M 6 x 1,0	M 10 x 1,5	14 mm	FE06	10	9,46	FA46	10	20,83	FAE06	10	55,44	1-FMS46	100	36,12
			1-FE06	100	35,91	1-FA46	100	86,56	1-FAE06	100	168,11			
M 8 x 1,25	M 12 x 1,5	15 mm	FE08	10	11,97	FA48	10	29,59	FAE08	10	62,74	1-FMS48	100	55,99
			1-FE08	100	45,85	1-FA48	100	116,59	1-FAE08	100	190,16			
M 10 x 1,5	M 14 x 1,5	18 mm	FE10	10	18,83	FA410	10	41,57	FAE10	10	98,91	1-FMS410	100	89,36
			1-FE10	100	68,64	1-FA410	100	170,87	1-FAE10	100	299,78			
M 12 x 1,5	M 16 x 1,5	22 mm	FE125	5	18,09									
			1-FE125	100	115,97									
M 12 x 1,75	M 16 x 1,5	22 mm	FE12	5	18,83	FA412	10	69,27	FAE12	10	111,20	1-FMS412	100	*
			1-FE12	100	98,51	1-FA412	100	284,81	1-FAE12	100	342,41			
M 14 x 1,5	M 18 x 1,5	24 mm	FE145	5	20,70									
			1-FE145	100	103,50									
M 14 x 2,0	M 18 x 1,5	24 mm	FE14	5	13,63									
			1-FE14	50	59,47									
M 16 x 2,0	M 20 x 1,5	22 mm	FE16	5	16,24	FA416	5	82,00				1-FMS416	50	*
			1-FE16	50	77,56	1-FA416	50	281,73						
M 18 x 2,5	M 22 x 1,5	24 mm	FE18	50	291,17									
			1-FE18	50	291,17									
M 20 x 2,5	M 26 x 1,5	27 mm	FE20	5	43,17	FA420	5	84,89						
			1-FE20	50	157,42	1-FA420	50	417,38						
M 22 x 2,5	M 26 x 1,5	30 mm	FE22	50	250,44									
			1-FE22	50	250,44									
M 24 x 3,0	M 30 x 1,5	30 mm	FE24	5	63,87									
			1-FE24	50	250,44	1-FA424	50	*						

UNC

UNC 1/4 x 20*	M 10 x 1,5	14 mm	FE74	10	14,13									
			1-FE74	100	*									
UNC 5/16 x 18*	M 12 x 1,5	15 mm	FE75	10	18,00									
			1-FE75	100	*									
UNC 3/8 x 16*	M 14 x 1,5	18 mm	FE76	5	15,46									
			1-FE76	100	*									
UNC 7/16 x 14*	M 16 x 1,5	22 mm	FE77	5	18,72									
			1-FE77	100	*									
UNC 1/2 x 13*	M 18 x 1,5	22 mm	FE78	5	22,59									
			1-FE78	100	*									
UNC 5/8 x 11*	M 20 x 1,5	22 mm	FE79		*									

UNF

UNF 1/4 x 28*	M 10 x 1,5	14 mm	FE84	10	14,13									
			1-FE84	100	*									
UNF 5/16 x 24*	M 12 x 1,5	15 mm	FE85	10	18,00									
			1-FE85	100	*									
UNF 3/8 x 24*	M 14 x 1,5	18 mm	FE86	5	15,46									
			1-FE86	100	*									
UNF 7/16 x 20*	M 16 x 1,5	22 mm	FE87	5	18,72									
			1-FE87	100	*									
UNF 1/2 x 20*	M 18 x 1,5	22 mm	FE88	5	22,59									
			1-FE88	100	*									
UNF 5/8 x 18*	M 20 x 1,5	22 mm	FE89		*									

Stainless steel 1.4105, and other materials on request

i Please see borehole- and further technical information on page 22 - 23.

* prices are on request

BaerFix® Thread Inserts with cutting slots

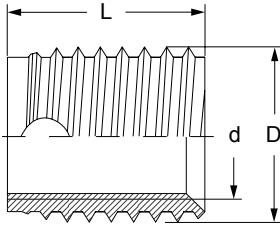

Material

Case-hardened steel, zinc-plated, conform to RoHS

d	D	L	No.	packing unit	€ per pack. unit
M 3 x 0,5	M 5 x 0,6	4 mm	FEL03	10	7,61
			1-FEL03	100	30,80
M 3 x 0,5	M 5 x 0,6	6 mm	1-FEL03	100	40,46
M 4 x 0,7	M 6,5 x 0,8	6 mm	FEL04	10	9,30
			1-FEL04	100	37,32
M 4 x 0,7	M 6,5 x 0,8	8 mm	1-FEL04	100	38,64
M 5 x 0,8	M 8 x 1,0	7 mm	FEL05	10	10,14
			1-FEL05	100	40,81
M 5 x 0,8	M 8 x 1,0	10 mm	1-FEL05	100	42,50
M 6 x 1,0	M 10 x 1,25	8 mm	FEL06	10	10,63
			1-FEL06	100	46,61
M 6 x 1,0	M 10 x 1,25	12 mm	1-FEL06	100	53,02
M 8 x 1,25	M 12 x 1,5	9 mm	FEL08	10	12,93
			1-FEL08	100	51,57
M 8 x 1,25	M 12 x 1,5	14 mm	1-FEL08	100	64,00
M 10 x 1,5	M 14 x 1,5	10 mm	FEL10	10	17,51
			1-FEL10	100	68,83
M 10 x 1,5	M 14 x 1,5	18 mm	1-FEL10	100	80,90
M 12 x 1,75	M 16 x 1,75	12 mm	FEL12	10	24,09
			1-FEL12	100	96,60
M 12 x 1,75	M 16 x 1,75	22 mm	1-FEL12	100	121,96
M 16 x 2,0	M 20 x 2,0	14 mm	FEL16	5	18,11
			1-FEL16	50	78,49
M 16 x 2,0	M 20 x 2,0	24 mm	1-FEL16	50	102,64



Further dimensions on request

Material

Stainless steel 1.4305 (AISI 303)

d	D	L	No.	packing unit	€ per pack. unit
M 3 x 0,5	M 5 x 0,6	4 mm	FAL03	10	22,52
			1-FAL03	100	87,18
M 3 x 0,5	M 5 x 0,6	6 mm	1-FAL03	100	104,94
M 4 x 0,7	M 6,5 x 0,8	6 mm	FAL04	10	24,15
			1-FAL04	100	96,00
M 4 x 0,7	M 6,5 x 0,8	8 mm	1-FAL04	100	112,67
M 5 x 0,8	M 8 x 1,0	7 mm	FAL05	10	26,32
			1-FAL05	100	104,94
M 5 x 0,8	M 8 x 1,0	10 mm	1-FAL05	100	128,00
M 6 x 1,0	M 10 x 1,25	8 mm	FAL06	10	42,26
			1-FAL06	100	119,06
M 6 x 1,0	M 10 x 1,25	12 mm	1-FAL06	100	140,79
M 8 x 1,25	M 12 x 1,5	9 mm	FAL08	10	32,12
			1-FAL08	100	128,00
M 8 x 1,25	M 12 x 1,5	14 mm	1-FAL08	100	152,33
M 10 x 1,5	M 14 x 1,5	10 mm	FAL10	10	43,47
			1-FAL10	100	172,80
M 10 x 1,5	M 14 x 1,5	18 mm	1-FAL10	100	198,40
M 12 x 1,75	M 16 x 1,75	12 mm	FAL12	10	72,02
			1-FAL12	100	287,99



Further dimensions on request

BaerFix® Thread Inserts with cutting holes for spark plug

Material

Case-hardened steel, zinc-plated

d	D	L		No.	packing unit	€ pro VPE
M 10 x 1,0	special size	8 mm	12,4 mm	FE101008	5	16,31
M 10 x 1,0	special size	13 mm	12,4 mm	FE101013	5	16,31
M 12 x 1,25	special size	10 mm	14,5 mm	FE121210	5	16,31
M 12 x 1,25	special size	14 mm	14,5 mm	FE121214	5	16,31
M 14 x 1,25	M 17,7 x 1,25	9 mm	17,0 mm	FE141259	5	25,48
M 14 x 1,25	M 17,7 x 1,25	15 mm	17,0 mm	FE141251	5	31,94



BaerFix® Thread Inserts for special applications

BAER Company develops and produces customer-oriented thread inserts and threading tools. Special applications can have special requirements to materials, dimensions, corrosion resistance, force effects, lifting capacities, pull out-strength or many more. Please send us your inquiry or give us a call. We enjoy to consult you in your applications.

- BaerFix® Thread Inserts with cutting holes, self-tapping
- BaerFix® Thread Inserts with hexagonal socket, self-tapping
- BaerFix® Thread Inserts for cold installation
- BaerFix® Thread Inserts for heat installation
- BaerFix® Thread Inserts for ultrasonic installation
- BaerFix® Thread Inserts for Screwing into a threaded hole
- Custom-made thread thread inserts (detail drawing or samples)



Instruction for use

1

Drilling

Clear the damaged thread with a drill bit or create a new hole in the parent material. For strong, hard and tough materials it is recommended to tap the thread (max. intermediate tap) before the installation of BaerFix® Inserts.



2

Screwing BaerFix® Insert on the inserting tool

Screw the BaerFix® Insert, with cutting slots or holes pointing downwards, on the inserting tool. Lock the BaerFix® Insert with the nut by wrench.



3

Installing the insert

Screw the BaerFix® Insert into the borehole. The BaerFix® Thread Insert is self-tapping. The inserting tool has a 1/4" hexagonal shank and can be used by a cordless screwdriver or a wrench socket.



4

Screwing off the inserting tool

Unlock the counternut by a wrench and screw off the inserting tool. Created bolted connections with BaerFix® Inserts are vibration resistant, wear-free and have a high load capacity in materials with low shearing strength.

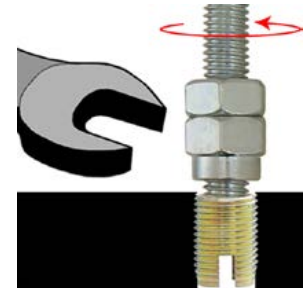

Installation by machine

1

Drilling

Clear the damaged thread with a drill bit or create a new hole in the parent material. For strong, hard and tough materials it is recommended to tap the thread (max. intermediate tap) before the installation of BaerFix® Inserts.



2

Configure the machine

Position the workpiece to ensure that hole and machine spindle are in alignment. Set the dimensions, speed values and driving depth (about 0,1 mm till 0,2 mm under the workpiece surface). Turn the external shell, so the stop pin can hold and drive the shell while rotating in clockwise direction. Screw the BaerFix® Insert, with cutting slots or holes pointing downwards, 2 till 4 windings on the inserting tool.



3

Installing the insert

Actuate the machine for screwing the insert into the hole, until the chosen driving depth is reached. Avoid a hard touchdown of the inserting tool on the workpiece to prevent damages on the inserting tool, thread insert or workpiece.



4

Screwing off the inserting tool

Set the machine on reverse running. The stop pin holds the shell while rotating in counterclockwise direction and screws out the inserting tool.



i Please see values for speed and installation torque on page 23.



BaerFix[®]





Thread Repair Kits





BaerFix® Thread Repair Kits - ECO

- Drill Bit HSS
- Inserting Tool with 1/4" hexagonal drive
- Adapter Nut - 1/4" hexagonal drive to 10 mm hexagonal drive
- BaerFix® Thread Insert with cutting slots
- Material: Case-hardened steel, zinc-plated
- Instruction for use

M	ISO metric thread					No.	€
M 2 x 0,4	EBS02*			4,20 mm	5	F001	20,54
M 2,5 x 0,45	EBS025*			4,20 mm	5	F002	20,54
M 3 x 0,5	KEBW03	NUT		4,70 mm	5	F003	20,54
M 4 x 0,7	KEBW04	NUT		6,10 mm	5	F004	20,54
M 5 x 0,8	KEBW05	NUT		7,50 mm	5	F005	21,63
M 6 x 1,0	KEBW06	NUT		9,30 mm	5	F006	20,54
M 8 x 1,25	KEBW08	NUT		11,40 mm	5	F008	22,82
M 10 x 1,5	KEBW10	NUT		13,25 mm	5	F010	28,59
M 12 x 1,5	KEBW1215	NUT		15,25 mm	5	F0125	59,07
M 12 x 1,75	KEBW12	NUT		15,25 mm	5	F012	33,15
M 14 x 1,5	BEBW1415*			17,00 mm	5	F0145	63,04
M 14 x 2,0	BEBW1420*			17,00 mm	5	F014	71,07
M 16 x 2,0	EBS16**			19,00 mm	5	F016	73,36
M 18 x 2,5	EBS18**			21,00 mm	5	F018	97,49
M 20 x 2,5	EBS20**			25,00 mm	5	F020	97,49





* Inserting Tool with 12 mm hexagonal drive instead of 1/4" hexagonal drive

** with EBS-Inserting Tool instead of Inserting Tool with 1/4" hexagonal drive

BaerFix® Thread Repair Kits - PRO

- Drill Bit HSS
- Countersink HSS with 1/4" hexagonal drive
- Inserting Tool with 1/4" hexagonal drive
- Adapter Nut - 1/4" hexagonal drive to 10 mm hexagonal drive
- BaerFix® Thread Insert with cutting slots
- Material: Case-hardened steel, zinc-plated
- Instruction for use

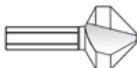

M	ISO metric thread						No.	€
M 3 x 0,5	KEBW03	NUT		10,4 mm	4,70 mm	10	F003P	32,72
M 4 x 0,7	KEBW04	NUT		10,4 mm	6,10 mm	10	F004P	32,72
M 5 x 0,8	KEBW05	NUT		10,4 mm	7,50 mm	10	F005P	32,72
M 6 x 1,0	KEBW06	NUT		10,4 mm	9,30 mm	10	F006P	32,72
M 8 x 1,25	KEBW08	NUT		16,5 mm	11,40 mm	10	F008P	37,28
M 10 x 1,5	KEBW10	NUT		16,5 mm	13,25 mm	10	F010P	44,56
M 12 x 1,75	KEBW12	NUT		16,5 mm	15,25 mm	10	F012P	51,63



BaerFix® Thread Repair Kits

- Drill Bit HSS
- Inserting Tool with 1/4" hexagonal drive
- Adapter Nut - 1/4" hexagonal drive to 10 mm hexagonal drive
- BaerFix® Thread Insert with cutting slots
- Material: Case-hardened steel, zinc-plated
- Instruction for use

UNC	Unified National Coarse Thread Series ANSI B1.1					No.	€
UNC 1/4 x 20	KEBW21	NUT	9,30 mm	5	FC001	52,60	
UNC 5/16 x 18	KEBW22	NUT	11,40 mm	5	FC002	57,82	
UNC 3/8 x 16	KEBW23	NUT	13,25 mm	5	FC003	75,53	
UNC 7/16 x 14	KEBW24	NUT	15,25 mm	5	FC004	103,02	
UNC 1/2 x 13	BEBW25*		17,00 mm	5	FC005	114,54	

* Inserting Tool with 10 mm hexagonal drive instead of 1/4" hexagonal drive

BaerFix® Thread Repair Kits

- Drill Bit HSS
- Inserting Tool with 1/4" hexagonal drive
- Adapter Nut - 1/4" hexagonal drive to 10 mm hexagonal drive
- BaerFix® Thread Insert with cutting slots
- Material: Case-hardened steel, zinc-plated
- Instruction for use



UNF	Unified National Fine Thread Series ANSI B1.1					No.	€
UNF 1/4 x 28	KEBW31	NUT	9,30 mm	5	FF001	52,60	
UNF 5/16 x 24	KEBW32	NUT	11,40 mm	5	FF002	132,91	
UNF 3/8 x 24	KEBW33	NUT	13,25 mm	5	FF003	68,68	
UNF 7/16 x 20	KEBW34	NUT	15,25 mm	5	FF004	75,53	
UNF 1/2 x 20	BEBW35*		17,00 mm	5	FF005	114,54	

* Inserting Tool with 10 mm hexagonal drive instead of 1/4" hexagonal drive



BaerFix® Thread Repair Kits for Spark Plug



- Drill Bit HSS
- Drill Bit with reduced shank (13 mm) HSS
- Inserting Tool with hexagonal drive
- BaerFix® Thread Insert with cutting holes, 2 different lengths
- Material: Case-hardened steel, zinc-plated
- Instruction for use

					No.	€
M 10 x 1,0	ZEBW10	12,40	8 mm 2	13 mm 2	F1010	57,06
M 12 x 1,25	ZEBW12	14,50	10 mm 2	14 mm 2	F12125	57,06
M 14 x 1,25	ZBEBW14	17,00	9 mm 2	15 mm 2	F14125	57,06



1
Drilling



2
Screwing a
BaerFix® Insert
on the inserting
tool



3
Installing
the insert

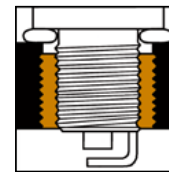



3
Unlocking the
counternut and
screwing off the
inserting tool

BaerFix® Thread Inserts with cutting holes for spark plug

Material

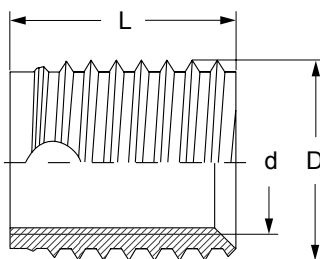
Case-hardened steel, zinc-plated



d	D	L		No.	packin unit	€ pro VPE
M 10 x 1,0	special size	8 mm	12,4 mm	FE101008	5	16,31
M 10 x 1,0	special size	13 mm	12,4 mm	FE101013	5	16,31
M 12 x 1,25	special size	10 mm	14,5 mm	FE121210	5	16,31
M 12 x 1,25	special size	14 mm	14,5 mm	FE121214	5	16,31
M 14 x 1,25	M 17,7 x 1,25	9 mm	17,0 mm	FE141259	5	25,48
M 14 x 1,25	M 17,7 x 1,25	15 mm	17,0 mm	FE141251	5	31,94



BaerFix[®]



**Thread Repair
Workshop Kits**





BaerFix® Thread Repair Workshop Kits - ECO

- Drill Bit HSS
- Inserting Tool with 1/4" hexagonal drive
- Adapter Nut - 1/4" hexagonal drive to 10 mm hexagonal drive
- BaerFix® Thread Insert with cutting slots
- Material: Case-hardened steel, zinc-plated
- Instruction for use

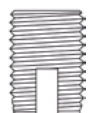

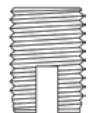

M 3 - M 12

					No.	€
M 3 x 0,5	KEBW03		4,70 mm	5		
M 4 x 0,7	KEBW04		6,10 mm	5		
M 5 x 0,8	KEBW05		7,50 mm	5		
M 6 x 1,0	KEBW06	NUT	9,30 mm	5	F312	169,97
M 8 x 1,25	KEBW08		11,40 mm	5		
M 10 x 1,5	KEBW10		13,25 mm	5		
M 12 x 1,75	KEBW12		15,25 mm	5		

M 5 - M 12

					No.	€
M 5 x 0,8	KEBW05		7,50 mm	5		
M 6 x 1,0	KEBW06		9,30 mm	5		
M 8 x 1,25	KEBW08	NUT	11,40 mm	5	F512	113,02
M 10 x 1,5	KEBW10		13,25 mm	5		
M 12 x 1,75	KEBW12		15,25 mm	5		





M 3 - M 10

					No.	€
M 3 x 0,5	KEBW03		4,70 mm	5		
M 4 x 0,7	KEBW04		6,10 mm	5		
M 5 x 0,8	KEBW05		7,50 mm	5		
M 6 x 1,0	KEBW06	NUT	9,30 mm	5	F310	112,92
M 8 x 1,25	KEBW08		11,40 mm	5		
M 10 x 1,5	KEBW10		13,25 mm	5		







BaerFix® Thread Repair Workshop Kits - ECO

- Drill Bit HSS
- Inserting Tool with 1/4" hexagonal drive
- Adapter Nut - 1/4" hexagonal drive to 10 mm hexagonal drive
- BaerFix® Thread Insert with cutting slots
- Material: Case-hardened steel, zinc-plated
- Instruction for use

UNC 1/4 - UNC 1/2						No.	€
UNC 1/4 x 20	KEBW21			9,30 mm	5		
UNC 5/16 x 18	KEBW22			11,40 mm	5		
UNC 3/8 x 16	KEBW23	NUT		13,25 mm	5	FC300	500,99
UNC 7/16 x 14	KEBW24			15,25 mm	5		
UNC 1/2 x 13	BEBW25*			17,00 mm	5		

* Inserting Tool with 10 mm hexagonal drive instead of 1/4" hexagonal drive

UNF 1/4 - UNF 1/2						No.	€
UNF 1/4 x 28	KEBW31			9,30 mm	5		
UNF 5/16 x 24	KEBW32			11,40 mm	5		
UNF 3/8 x 24	KEBW33	NUT		13,25 mm	5	FF300	546,64
UNF 7/16 x 20	KEBW34			15,25 mm	5		
UNF 1/2 x 20	BEBW35*			17,00 mm	5		

* Inserting Tool with 10 mm hexagonal drive instead of 1/4" hexagonal drive



BaerFix® Thread Repair Workshop Kits - PRO

- Drill Bit HSS
- Countersink HSS with 1/4" hexagonal drive
- Inserting Tool with 1/4" hexagonal drive
- Adapter Nut - 1/4" hexagonal drive to 10 mm hexagonal drive
- BaerFix® Thread Insert with cutting slots
- Material: Case-hardened steel, zinc-plated
- Instruction for use

M 3 - M 12							No.	€
M 3 x 0,5	KEBW03	NUT	10,4 mm	4,70 mm	10	F312P	216,70	
M 4 x 0,7	KEBW04			6,10 mm	10			
M 5 x 0,8	KEBW05			7,50 mm	10			
M 6 x 1,0	KEBW06			9,30 mm	10			
M 8 x 1,25	KEBW08			11,40 mm	10			
M 10 x 1,5	KEBW10			13,25 mm	10			
M 12 x 1,75	KEBW12			15,25 mm	10			

M 5 - M 12							No.	€
M 5 x 0,8	KEBW05	NUT	10,4 mm	7,50 mm	10	F512P	159,65	
M 6 x 1,0	KEBW06			9,30 mm	10			
M 8 x 1,25	KEBW08			11,40 mm	10			
M 10 x 1,5	KEBW10			13,25 mm	10			
M 12 x 1,75	KEBW12			15,25 mm	10			

M 3 - M 10							No.	€
M 3 x 0,5	KEBW03	NUT	10,4 mm	4,70 mm	10	F310P	159,65	
M 4 x 0,7	KEBW04			6,10 mm	10			
M 5 x 0,8	KEBW05			7,50 mm	10			
M 6 x 1,0	KEBW06			9,30 mm	10			
M 8 x 1,25	KEBW08			11,40 mm	10			
M 10 x 1,5	KEBW10			13,25 mm	10			



BaerFix[®]



Inserting Tools



BaerFix® Inserting Tools

with 1/4" hexagonal drive



	Length			No.	€
M 3 x 0,5	46,00 mm	5,50 mm	1/4"	1-KEBW03	9,21
M 4 x 0,7	48,00 mm	7,00 mm	1/4"	1-KEBW04	9,21
M 5 x 0,8	57,00 mm	8,00 mm	1/4"	1-KEBW05	9,21
M 6 x 1,0	62,00 mm	10,00 mm	1/4"	1-KEBW06	9,21
M 7 x 1,0	72,00 mm	11,00 mm	1/4"	1-KEBW07	9,70
M 8 x 1,25	72,00 mm	13,00 mm	1/4"	1-KEBW08	11,22
M 10 x 1,0	77,00 mm	17,00 mm	1/4"	1-KEBW1010	12,92
M 10 x 1,5	82,00 mm	17,00 mm	1/4"	1-KEBW10	12,53
M 12 x 1,25	79,00 mm	19,00 mm	1/4"	1-KEBW1212	14,68
M 12 x 1,5	79,00 mm	19,00 mm	1/4"	1-KEBW1215	14,68
M 12 x 1,75	92,00 mm	19,00 mm	1/4"	1-KEBW12	13,83
M 14 x 1,5	114,00 mm	19,00 mm	12 mm	BEBW1415	14,68
M 14 x 2,0	114,00 mm	19,00 mm	12 mm	BEBW1420	14,68
UNC 1/4 x 20	62,00 mm	7/16 "	1/4"	1-KEBW21	10,46
UNC 5/16 x 18	67,00 mm	1/2 "	1/4"	1-KEBW22	10,46
UNC 3/8 x 16	77,00 mm	9/16 "	1/4"	1-KEBW23	12,76
UNC 7/16 x 14	87,00 mm	11/16 "	1/4"	1-KEBW24	14,20
UNC 1/2 x 13	117,00 mm	3/4 "	10 mm	BEBW25	14,86
UNF 1/4 x 28	62,00 mm	7/16 "	1/4"	1-KEBW31	10,46
UNF 5/16 x 24	67,00 mm	1/2 "	1/4"	1-KEBW32	10,46
UNF 3/8 x 24	77,00 mm	9/16 "	1/4"	1-KEBW33	12,76
UNF 7/16 x 20	87,00 mm	11/16 "	1/4"	1-KEBW34	14,20
UNF 1/2 x 20	117,00 mm	3/4 "	10 mm	BEBW35	14,86

BaerFix® Machine Inserting Tools

with square drive



	D1	D2	L	 No.	€
M 3 x 0,5	8 mm	18 mm	80 mm	6 mm	MEBW03 75,08
M 4 x 0,7	8 mm	18 mm	80 mm	6 mm	MEBW04 75,08
M 5 x 0,8	12,5 mm	30 mm	96,5 mm	10 mm	MEBW05 95,24
M 6 x 1,0	12,5 mm	30 mm	96,5 mm	10 mm	MEBW06 95,24
M 8 x 1,25	12,5 mm	30 mm	96,5 mm	10 mm	MEBW08 95,24
M 10 x 1,5	13 mm	40 mm	110 mm	10 mm	MEBW10 123,59
M 12 x 1,75	13 mm	40 mm	110 mm	10 mm	MEBW12 123,59
M 14 x 2,0	13 mm	40 mm	110 mm	10 mm	MEBW14 224,07
M 16 x 2,0	13 mm	40 mm	110 mm	10 mm	MEBW16 237,93

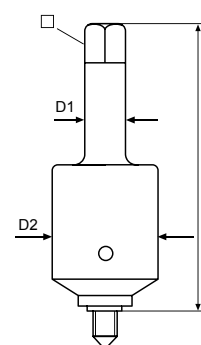

i Please see values for speed and installation torque on page 23.

BaerFix® Inserting Tools for spark plug

with hexagonal drive



	Length		No.	€
M 10 x 1,0	128,00 mm	17 mm	ZEBW10	18,15
M 12 x 1,25	128,00 mm	19 mm	ZEBW12	19,29
M 14 x 1,25	128,00 mm	19 mm	ZEBW14	20,43

BaerFix® Drill Bits



DIN 338 - HSS Straight Shank Drill Bit



DIN 338-A - HSS Reduced Shank Drill Bit (13 or 16 mm)



DIN 345 - HSS Morse Taper Shank Drill Bit

Ø	M	M	UNC	UNF	BSW	DIN	No.	€
4,20 mm	M 2 x 0,4	M 2,5 x 0,45				338	1-16142	1,30
4,70 mm	M 3 x 0,5		UNC 4 x 40	UNF 4 x 40		338	1-16147	1,20
5,60 mm	M 3,5 x 0,6		UNC 6 x 32	UNF 6 x 40		338	1-16156	2,07
6,10 mm	M 4 x 0,7		UNC 8 x 32	UNF 8 x 36		338	1-16161	2,29
7,50 mm	M 5 x 0,8		UNC 10 x 24	UNF 10 x 32		338	1-16175	3,04
9,30 mm	M 6 x 1,0		UNC 1/4 x 20	UNF 1/4 x 28	BSW 1/4 x 20	338	1-16193	4,35
11,30 mm	M 8 x 1,25		UNC 5/16 x 18	UNF 5/16 x 24	BSW 5/16 x 18	338	1-161113	7,94
12,40 mm	M 10 x 1,0*					338-A	1-161124	#NV
13,25 mm	M 10 x 1,5		UNC 3/8 x 16	UNF 3/8 x 24	BSW 3/8 x 16	338-A	1-111132	18,81
14,50 mm	M 12 x 1,25*					338-A	1-111145	#NV
15,25 mm	M 12 x 1,75		UNC 7/16 x 14	UNF 7/16 x 20	BSW 7/16 x 14	338-A	1-111152	27,17
17,00 mm	M 14 x 2,0	M 14 x 1,25*	UNC 1/2 x 13	UNF 1/2 x 20	BSW 1/2 x 13	338-A	1-111170	34,02
19,00 mm	M 16 x 2,0		UNC 5/8 x 11	UNF 5/8 x 18	BSW 5/8 x 11	338-A	1-111190	34,02
21,00 mm	M 18 x 2,5					338-A	1-111210	46,19
25,00 mm	M 20 x 2,5	M 22 x 2,5	UNC 3/4 x 10	UNF 3/4 x 16		338-A	1-111250	62,81
29,00 mm	M 24 x 3,0					338-A	1-111290	85,64
33,00 mm	M 27 x 3,0					345	1-130330	188,23
35,00 mm	M 30 x 3,5					345	1-130350	211,05

* for spark plug thread inserts

The drill bit diameters are approximate diameters. Brittle, tough and hard materials need a larger borehole than soft or elastic materials.

BaerFix® Countersink HSSG

with 1/4" hexagonal drive
to countersink a borehole



Ø	M	UNC	UNF	BSW		No.	€
10,4 mm	M 2 x 0,4 - M 6 x 1,0	UNC 4 x 40 – UNC 1/4	UNF 4 x 48 – UNF 1/4		1/4"	1-B9402	10,16
16,5 mm	M 8 x 1,25 - M 12 x 1,75	UNC 5/16 – UNC 7/16	UNF 5/16 – UNF 7/16	BSW 1/4 – BSW 7/16	1/4"	1-B9403	11,30

Generally it is not necessary to countersink the bore hole. However, we do recommend a countersink to avoid warping the workpiece surface when screwing in the insert.

BaerFix® Adapter Nut

1/4" internal hexagon to 10 mm outside hexagon

internal hexagon	external hexagon	No.	€
1/4"	10 mm	B9501	3,47





BaerFix[®]

Technical Data



Automatensähle, kaltegezogen			
Verzinsung	Verzinsung	Verzinsung	Verzinsung
g	g	g	g
1,0721	1,0722	1,0723	1,0724
1,0725	1,0726	1,0727	1,0728
1,0729	1,0730	1,0731	1,0732
1,0733	1,0734	1,0735	1,0736
1,0737	1,0738	1,0739	1,0740
1,0741	1,0742	1,0743	1,0744
1,0745	1,0746	1,0747	1,0748
1,0749	1,0750	1,0751	1,0752
1,0753	1,0754	1,0755	1,0756
1,0757	1,0758	1,0759	1,0760
1,0761	1,0762	1,0763	1,0764
1,0765	1,0766	1,0767	1,0768
1,0769	1,0770	1,0771	1,0772
1,0773	1,0774	1,0775	1,0776
1,0777	1,0778	1,0779	1,0780
1,0781	1,0782	1,0783	1,0784
1,0785	1,0786	1,0787	1,0788
1,0789	1,0790	1,0791	1,0792
1,0793	1,0794	1,0795	1,0796
1,0797	1,0798	1,0799	1,0800



Recommended borehole diameter

		BaerFix® Thread Inserts with cutting slots				BaerFix® Thread Inserts with cutting holes				
materials	Light alloys tensile strength [N/mm ²]	< 250 N/mm ²			< 300 N/mm ²			< 350 N/mm ²		
	Brass, NF-metals, bronze	< 300 N/mm ²			< 350 N/mm ²			> 350 N/mm ²		
	Cast iron brinell hardness [HB]	< 150 HB			< 200 HB			> 200 HB		
internal thread	M 2 x 0,4	4,1 mm	4,2 mm	4,3 mm						
	M 2,5 x 0,45	4,1 mm	4,2 mm	4,3 mm						
	M 3 x 0,5		4,6 mm	4,7 mm	4,8 mm	4,6 mm	4,7 mm	4,8 mm		
	M 4 x 0,7	5,9 mm	6,0 mm	6,1 mm	6,2 mm	6,0 mm	6,1 mm	6,2 mm		
	M 5 x 0,8	7,2 mm	7,3 mm	7,5 mm	7,6 mm	7,4 mm	7,5 mm	7,6 mm	7,7 mm	
	M 6 x 1,0 thin walled	8,2 mm	8,3 mm	8,5 mm	8,6 mm					
	M 6 x 1,0	8,8 mm	9,0 mm	9,2 mm	9,4 mm	9,3 mm	9,4 mm	9,5 mm	9,6 mm	
	M 8 x 1,25	10,8 mm	11,0 mm	11,2 mm	11,4 mm	11,1 mm	11,2 mm	11,3 mm	11,5 mm	
	M 10 x 1,5	12,8 mm	13,0 mm	13,2 mm	13,4 mm	13,1 mm	13,2 mm	13,3 mm	13,5 mm	
	M 12 x 1,75	14,8 mm	15,0 mm	15,2 mm	15,4 mm	15,0 mm	15,1 mm	15,2 mm	15,4 mm	
	M 14 x 2,0	16,8 mm	17,0 mm	17,2 mm	17,4 mm	17,0 mm	17,1 mm	17,2 mm	17,4 mm	
	M 16 x 2,0	18,8 mm	19,0 mm	19,2 mm	19,4 mm	19,0 mm	19,1 mm	19,2 mm	19,4 mm	
	M 18 x 2,5	20,8 mm	21,0 mm	21,2 mm	21,4 mm					
	M 20 x 2,5	24,8 mm	25,0 mm	25,2 mm	25,4 mm					
	M 22 x 2,5	24,8 mm	25,0 mm	25,2 mm	25,4 mm					
	M 24 x 3,0	28,8 mm	29,0 mm	29,2 mm	29,4 mm					
	M 27 x 3,0	32,8 mm	33,0 mm	33,2 mm	33,4 mm					
	M 30 x 3,5	34,8 mm	35,0 mm	35,2 mm	35,4 mm					
Flange cover	ca. 60%	ca. 50%	ca. 40%	ca. 30%	ca. 80%	ca. 70%	ca. 60%	ca. 50%		

possibly lubrication required

Minimum wall thickness for BaerFix® inserts

	BaerFix® Thread Inserts with cutting slots			BaerFix® Thread Inserts with cutting holes		
	light alloys	cast iron	plastics	light alloys	cast iron	plastics
M 2 x 0,4	0,90 mm	1,35 mm	1,13 mm			
M 2,5 x 0,45	0,90 mm	1,35 mm	1,13 mm			
M 3 x 0,5	1,00 mm	1,50 mm	1,25 mm	1,00 mm	1,50 mm	1,25 mm
M 4 x 0,7	1,30 mm	1,95 mm	1,63 mm	1,30 mm	1,95 mm	1,63 mm
M 5 x 0,8	1,60 mm	2,40 mm	2,00 mm	1,60 mm	2,40 mm	2,00 mm
M 6 x 1,0	2,00 mm	3,00 mm	2,50 mm	2,00 mm	3,00 mm	2,50 mm
M 8 x 1,25	2,40 mm	3,60 mm	3,00 mm	2,40 mm	3,60 mm	3,00 mm
M 10 x 1,5	2,80 mm	4,20 mm	3,50 mm	2,80 mm	4,20 mm	3,50 mm
M 12 x 1,75	3,20 mm	4,80 mm	4,00 mm	3,20 mm	4,80 mm	4,00 mm
M 14 x 2,0	3,60 mm	5,40 mm	4,50 mm	3,60 mm	5,40 mm	4,50 mm
M 16 x 2,0	4,00 mm	6,00 mm	5,00 mm	4,00 mm	6,00 mm	5,00 mm
M 18 x 2,5	4,40 mm	6,60 mm	5,50 mm			
M 20 x 2,5	5,20 mm	7,80 mm	6,50 mm			
M 22 x 2,5	5,20 mm	7,80 mm	6,50 mm			
M 24 x 3,0	6,00 mm	9,00 mm	7,50 mm			
M 27 x 3,0	6,80 mm	10,20 mm	8,50 mm			
M 30 x 3,5	7,20 mm	10,80 mm	9,00 mm			

Calculation for minimum values

d = internal diameter BaerFix® Insert
D = external diameter BaerFix® Insert
R = remaining wall thickness

$$R_{\min} \text{ (light alloys)} = 0,2 \times D$$

$$R_{\min} \text{ (cast iron)} = 0,3 \times D$$

$$R_{\min} \text{ (plastics)} = 0,25 \times D$$

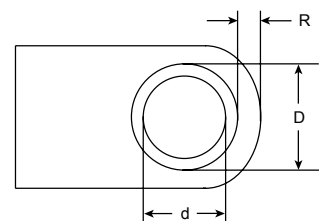

Minimal borehole depth

BaerFix® Thread Inserts with cutting slots



Internal Thread	Min. borehole depth for through holes	Min. borehole depth for blind holes
M 2 x 0,4	6,00 mm	8,00 mm
M 2,5 x 0,45	6,00 mm	8,00 mm
M 3 x 0,5	6,00 mm	8,00 mm
M 4 x 0,7	8,00 mm	10,00 mm
M 5 x 0,8	10,00 mm	13,00 mm
M 6 x 1,0	14,00 mm	17,00 mm
M 8 x 1,25	15,00 mm	18,00 mm
M 10 x 1,5	18,00 mm	22,00 mm
M 12 x 1,75	22,00 mm	26,00 mm
M 14 x 2,0	24,00 mm	28,00 mm
M 16 x 2,0	22,00 mm	27,00 mm
M 18 x 2,5	24,00 mm	29,00 mm
M 20 x 2,5	27,00 mm	32,00 mm
M 22 x 2,5	30,00 mm	36,00 mm
M 24 x 3,0	30,00 mm	36,00 mm
M 27 x 3,0	30,00 mm	36,00 mm
M 30 x 3,5	40,00 mm	46,00 mm

BaerFix® Thread Inserts with cutting holes



Internal Thread	Length	Min. borehole depth for through holes	Min. borehole depth for blind holes
M 3 x 0,5	4,00 mm	4,00 mm	6,00 mm
M 3 x 0,5	6,00 mm	6,00 mm	8,00 mm
M 4 x 0,7	6,00 mm	6,00 mm	8,00 mm
M 4 x 0,7	8,00 mm	8,00 mm	10,00 mm
M 5 x 0,8	7,00 mm	7,00 mm	9,00 mm
M 5 x 0,8	10,00 mm	10,00 mm	13,00 mm
M 6 x 1,0	8,00 mm	8,00 mm	10,00 mm
M 6 x 1,0	12,00 mm	12,00 mm	15,00 mm
M 8 x 1,25	9,00 mm	9,00 mm	11,00 mm
M 8 x 1,25	14,00 mm	14,00 mm	17,00 mm
M 10 x 1,5	10,00 mm	10,00 mm	13,00 mm
M 10 x 1,5	18,00 mm	18,00 mm	22,00 mm
M 12 x 1,75	12,00 mm	12,00 mm	15,00 mm
M 12 x 1,75	22,00 mm	22,00 mm	26,00 mm
M 16 x 2,0	24,00 mm	24,00 mm	28,00 mm

BaerFix® Thread Inserts with cutting slots



Internal Thread	Min. borehole depth for through holes	Min. borehole depth for blind holes
UNC 4 x 40	6,00 mm	8,00 mm
UNC 6 x 32	8,00 mm	10,00 mm
UNC 8 x 32	8,00 mm	10,00 mm
UNC 10 x 24	10,00 mm	13,00 mm
UNC 1/4 x 20	14,00 mm	17,00 mm
UNC 5/16 x 18	15,00 mm	18,00 mm
UNC 3/8 x 16	18,00 mm	22,00 mm
UNC 7/16 x 14	22,00 mm	26,00 mm
UNC 1/2 x 13	22,00 mm	28,00 mm
UNC 5/8 x 11	22,00 mm	27,00 mm

BaerFix® Thread Inserts with cutting slots



Internal Thread	Min. borehole depth for through holes	Min. borehole depth for blind holes
UNF 4 x 48	6,00 mm	8,00 mm
UNF 6 x 40	8,00 mm	10,00 mm
UNF 8 x 36	8,00 mm	10,00 mm
UNF 10 x 32	10,00 mm	13,00 mm
UNF 1/4 x 28	14,00 mm	17,00 mm
UNF 5/16 x 24	15,00 mm	18,00 mm
UNF 3/8 x 24	18,00 mm	22,00 mm
UNF 7/16 x 20	22,00 mm	26,00 mm
UNF 1/2 x 20	22,00 mm	28,00 mm
UNF 5/8 x 18	22,00 mm	27,00 mm

Tolerances

BaerFix® Inserts are produced according to ISO 2768-m

Internal metric threads: ISO 6H

External metric threads: works standard

Recommended values for machine installation

Speed values for light alloys

BaerFix® Internal Thread	Speed per min
M 2,5 - M 3	650 - 900
M 4 - M 5	400 - 600
M 6 - M 8	280 - 400
M 10 - M 12	200 - 300
M 14 - M 16	150 - 200
M 18 - M 20	120 - 200
M 22 - M 24	100 - 160
M 27 - M 30	80 - 140

Values for installation torque

BaerFix® Internal Thread	Torque [Nm]
M 2,5 x 0,45	1, 5 Nm
M 3 x 0,5	2, 5 Nm
M 4 x 0,7	5, 5 Nm
M 5 x 0,8	10, 0 Nm
M 6 x 1,0	15, 0 Nm
M 8 x 1,25	28, 0 Nm
M 10 x 1,5	40, 0 Nm
M 12 x 1,75	60, 0 Nm



BAER Vertriebs GmbH
Robert-Bosch-Str. 5
68542 Heddesheim
Germany

Tel: +49 (0) 6203 4048 790
Fax: +49 (0) 6203 4048 791
E-Mail: info@baercoil.com
www.baerfix.com

BaerFix[®]